

NOTE Wapiti aircraft varied considerably in detail, check with photographs before modelling any individual machine.

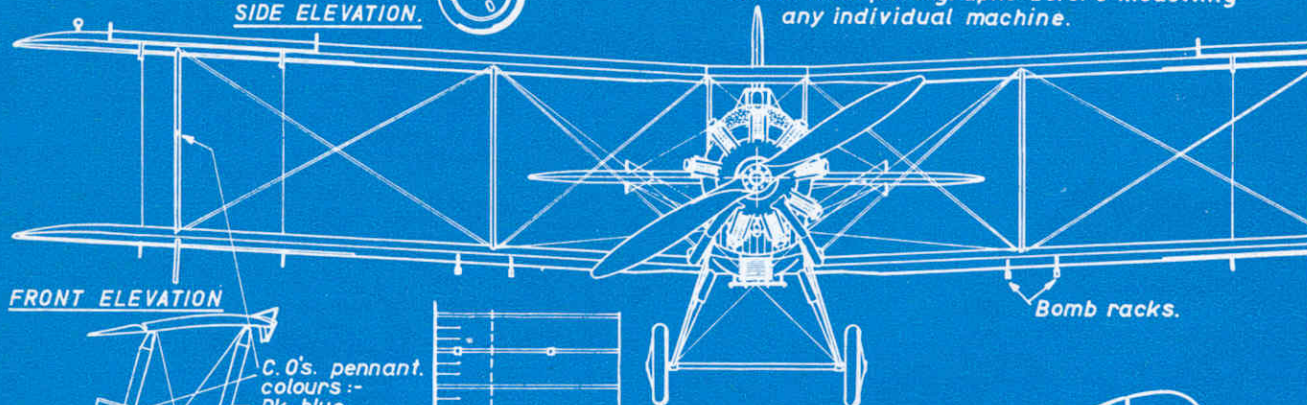

FRONT ELEVATION



SECTION AT OUTER STRUTS

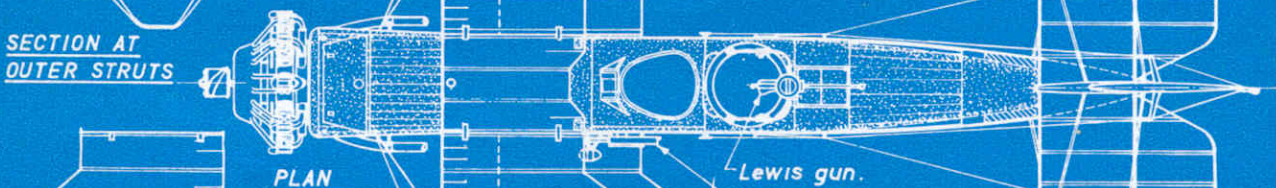

PLAN

UNDERSIDE LOWER WING

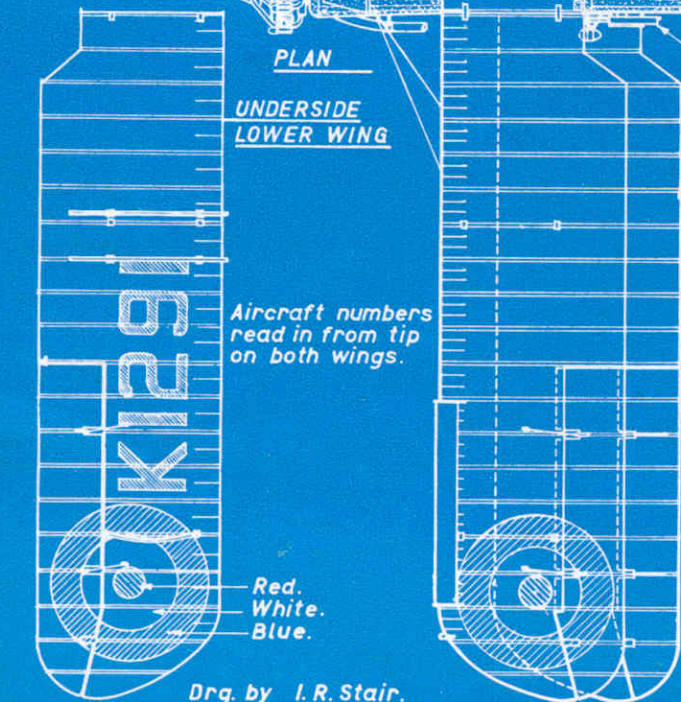

Aircraft numbers read in from tip on both wings.

Red.
White.
Blue.

UNDERSIDE FUSELAGE.

WESTLAND WAPITI Mk IIA.
BRISTOL JUPITER ENGINE.

K.1291. - Commanding Officers aircraft No. 27 (Bomber) Squadron, Kohat, India, 1936.

COLOURS :-
Wings, rear fuselage, tail unit - silver.
Forward fuselage, undercarriage - bright aluminium. Fuselage top - dark grey.
Struts, guns, tyres, engine, exhaust pipes, oil cooler, bomb racks, - black.

Drg. by I. R. Stair.

SCALE 0 5 ft.



CHALLENGE OF THE 'WAPITI'

The Westland Wallace is remembered for its record breaking flight over Everest, and the thrilling story of this adventure is told on page 14. The Frog 'Trailblazer' 1/72nd scale kit of the Wallace forms the basis of our plastic conversion this month, in which Doug McHard shows you how he produced from it a Wapiti—one of the most colourful and widely used R.A.F. aircraft of the '30s.

For our conversion, the wings and tail remain basically unaltered, and all the *essential* work involves the fuselage and undercarriage. But since the Wapiti engine, unlike that of the Wallace, is not enclosed in a cowling ring, and is a prominent feature of the machine, much of our article deals with the development and embellishment of this item, however, if you want to simplify the job, you can simply use the original Wallace engine moulding without the cowling ring.

Ian Stair's fine drawing on the facing page reveals a lot more Wapiti detail which expert modelers might wish to incorporate in their own conversions. A close study of these photographs of the Editor's model will provide the inspiration—now read on!

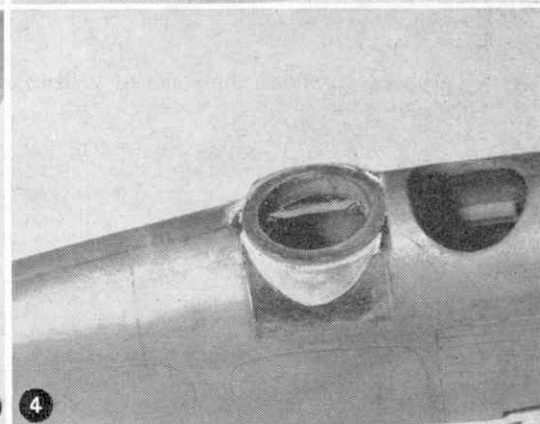
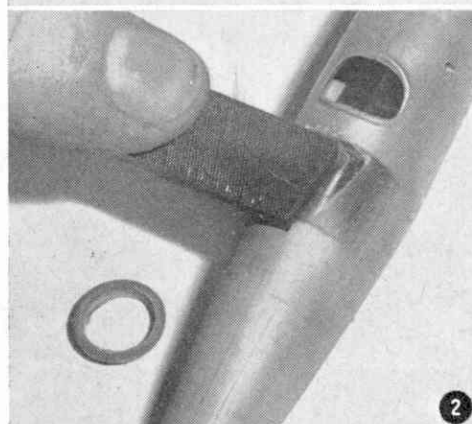
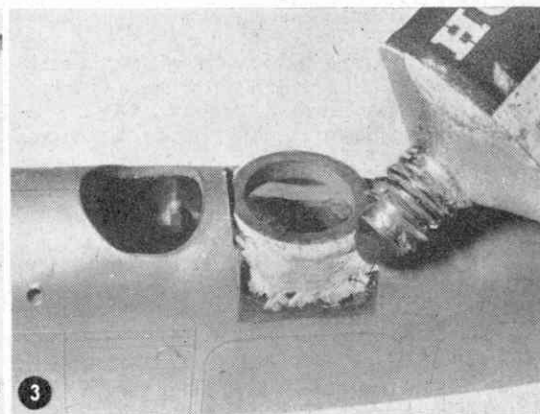
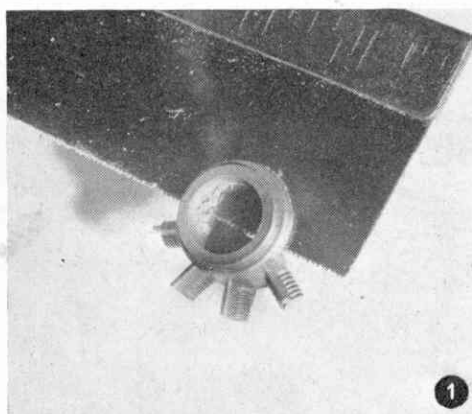

1 First job is to saw the rear rim off the engine moulding. This piece later becomes the rear cockpit gun-mounting ring, so don't throw it away!

2 The fuselage halves and the rear transparency are allowed to dry *thoroughly* and the top of the transparency is then filed flat (see drawing).

3 With a sharp knife, cut a hole to take the small diameter rim of the cut-off rear engine

ring, allowing the lower face of the larger diameter part to rest on the flat-filled rear transparency. Now apply Humbrol Body Putty as shown—more than required to allow for shrinkage—and let it dry overnight.

4 Using No. 280 and 400 wet or dry paper, shape the putty as shown, leaving a narrow lip round the top edge, 'open out' the cockpit and gun mount ring with a round file or 280 paper wrapped round a pencil.