

A Meccano Aerial Ropeway

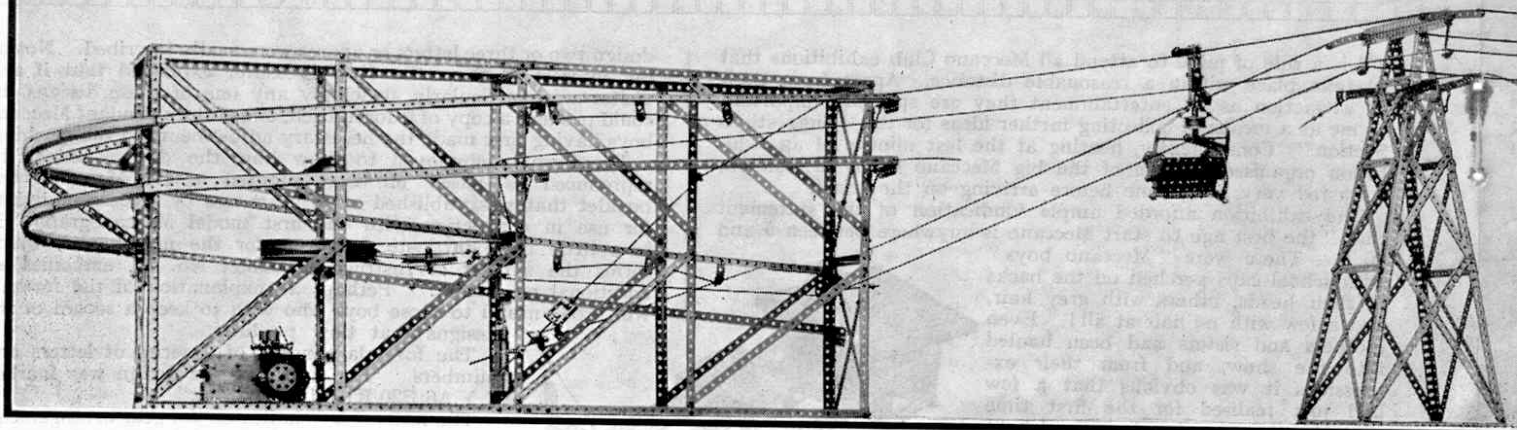

IN an article on overhead transport by means of electric telfers in the November, 1929 "M.M.," we mentioned the many advantages that were to be gained from the adoption of this means of transport. Chief amongst these advantages is its comparative cheapness in first cost and operation, and also the fact that the installation occupies very little ground space. The latter is a particularly valuable feature as it permits of easy deposit on growing dumps of waste material or increasing piles of stock.

Another form of overhead transport is afforded by aerial ropeways. In its simplest form the installation of a ropeway involves merely the stretching of a cable between two points and the provision of buckets or conveyors that may be hauled along it. Hence it may be gathered that for many kinds of work it shows important advantages over even an electric telfer. Particularly is this the case in constructional works and in the disposal of waste and material from mines, where the installation is more or less temporary.

Ropeways are used for pleasure as well as for serious purposes. One interesting example is the ropeway at Rio de Janeiro, by means of which passengers make the ascent to the summit of the Sugar Loaf, a mountain that dominates the beautiful harbour on which the city stands. A trip on this novel aerial ropeway was described and illustrated on page 901 of the "M.M." for November, 1928.

It is in connection with industrial purposes, however, that the greatest developments in ropeways are seen. In the South Wales coal-fields for example, ropeways have been adopted extensively within a comparatively short time for disposing of the waste from mine workings. In this district many of the mines are situated in deep valleys, the sides of which are extremely steep. Obviously the shale, etc., cannot be deposited near the mine on account of the small space available, or on the hill side because of the danger of subsidence, and so the best dumping ground is the comparatively flat tops of the mountains, which means that the hauling of loaded "tubs" to the top would be a slow and laborious process.

By the installation of a ropeway, however, all difficulties are overcome, for the steepness of the hillside and the nature of the ground in cases where it would be impossible to lay a "tramway," form no obstacle to a ropeway.

Much of the credit for the improvements that have made ropeways of such great value in modern industry is due to R. White & Sons, of

Widnes, Lancashire. On the often intricate and elaborate systems erected by this firm, the buckets that serve as carriers run on a wire cable of special design along which they are hauled by a lighter rope that is driven by an electric motor, or other power unit. They negotiate corners and angles without being removed from the carrier rope, and their contents may be tipped at any desired point along the route over which they travel. Practically all operations are automatic—the buckets even load themselves!—and a White aerial ropeway runs with a minimum of attention.

The Meccano Model

It would be difficult to find a more interesting prototype for a Meccano model than a White Ropeway, and we believe the model described in this article is one of the most realistic and impressive models that have so far been built in Meccano. The model will require a good deal of space—the more the better—and much care must be taken in its construction. We shall describe every detail in full, however, and there is no reason why any Meccano boy who has the parts at his disposal should not make a perfectly successful model.

Most of the salient features of the prototype have been reproduced entirely with the aid of Meccano standard parts, with the exception of the carrier rope, hauling rope, and the gripping device on the bucket—the latter consisting of a Bell Crank and 1½" Strip filed to a certain shape.

The general view at the head of this article gives a good idea of the appearance of the finished model. To detail the essential features of the apparatus, the photograph shows (commencing from the left) the operating station, where the driving machinery is situated and the automatic engagement and disengagement of the hauling rope from the bucket is effected; the bucket itself; a supporting tower; the hopper and bucket conveyor; the automatic loading plant; another supporting tower; and finally the return tower.

Construction of the Operating Station

The construction of the various units of the model should be done systematically, and we cannot do better than commence by building the operating station (Fig. 3). The main longitudinal members each consist of two 18½" Angle Girders joined together by a 3" Strip, and each pair of members so formed is connected

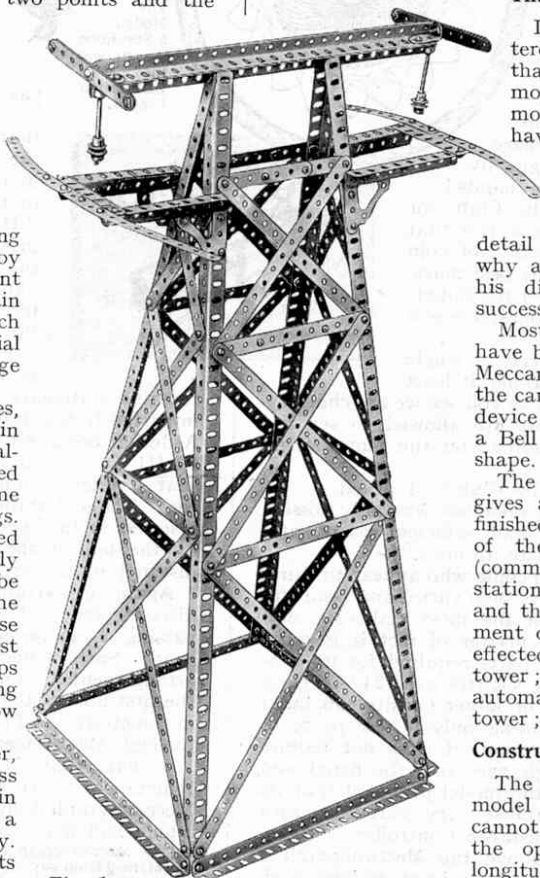
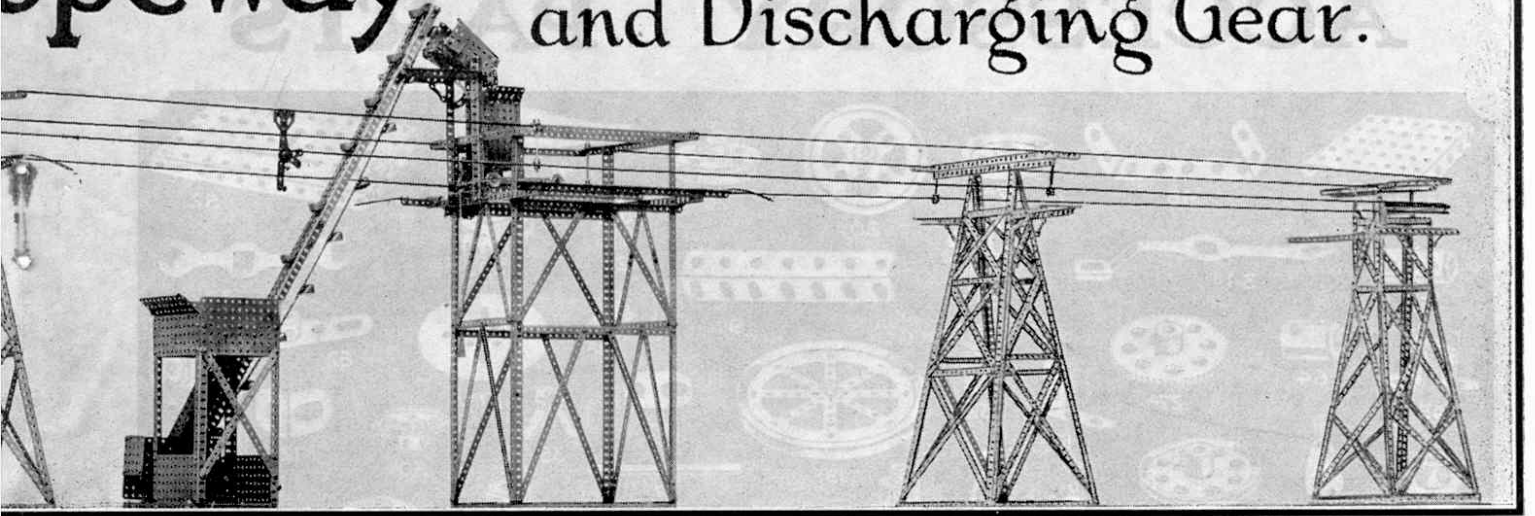

Fig. 1
One of the Supporting Towers.

Opeway with Automatic Pick-up and Discharging Gear.



at each end by $7\frac{1}{2}$ " Angle Girders. The vertical members are composed of $18\frac{1}{2}$ " Angle Girders, which should be spaced apart the distance indicated in the illustration.

The running rails 1 each consist of one $24\frac{1}{2}$ " and one $18\frac{1}{2}$ " Angle Girder overlapped seven holes and supported on the brackets 2, in an inverted position and slightly tilted, so that the rail section resembles an inverted "V." Each of the brackets 2 consists of a Flanged Bracket bolted by its shorter side to the vertical girders, and having its longer side extended by means of a $3\frac{1}{2}$ " Strip overlapping four holes in the case of the two brackets at the left-hand end of the structure, and by $3\frac{1}{2}$ " Strips overlapping five holes in the case of the remaining four. A $2\frac{1}{2}$ " Angle Girder is added to each bracket for strengthening purposes. The running rail is laid on the brackets in the manner indicated in the illustration, and is retained thereon by two Flat Brackets, which are bolted on either side of the rail and bent so that the projecting portions bed flat on the bracket. The Flat Brackets are then attached to the brackets 2 by means of nuts and bolts.

The curved portion of the running rail is formed by four Channel Segments, bolted rigidly together. The connection between the straight and curved sections on the far side of the model is formed by means of a $1" \times \frac{1}{2}"$ Angle Bracket, which is bolted by its longer side to the flange of the supporting bracket and to the underside of the Channel Segment. The near side connection is by means of a $\frac{1}{2}" \times \frac{1}{2}"$ Angle Bracket that is secured to the side of the supporting bracket and to the Segment. Care must be taken in making these connections to ensure that the outer flanges of the end Channel Segments are in alignment with the straight sections, so that the pulleys of the bucket may pass over the joints without fear of derailment.

The guard rails 3 are each composed of one $18\frac{1}{2}$ " and one $24\frac{1}{2}$ " Angle Girder and they are supported on brackets similar to the brackets 2. They are parallel to the running rails throughout their lengths and the distance between the running and guard rails is 3 ins. The curved guard rail should project $\frac{1}{2}"$ beyond the curved running rail and therefore the straight guard rails should project one hole beyond their supporting brackets.

The retarder rail 4, fitted for the dual purpose of slowing down the bucket and guiding it round the curve, consists of one $12\frac{1}{2}"$ and one 3" Strip bolted together. Five holes from its right-hand end it is

attached pivotally to a $\frac{1}{2}" \times \frac{1}{2}"$ Angle Bracket that is bolted to a $9\frac{1}{2}"$ Girder. This Girder is fixed by its slotted holes to the upright members of the main frame, so that the bottom edge of the retarder at its right-hand pivoted end may be set at $\frac{1}{2}"$ from the top of, and vertically above, the running rail. The left-hand end of the retarder is carried by a $\frac{3}{8}"$ Bolt, sliding freely in the slot of a $1" \times \frac{1}{2}"$ Angle Bracket, which is secured to a Girder bolted across the vertical members of the main frame. The retarder is vertically above the running rail throughout its length and at the left-hand end it is slightly closer to the running rail than at the entering end, although free to lift when required. Consequently as the bucket moves along the running rail, it raises the retarder, thus producing a mild braking effect. The end of the retarder projecting over the curved portion of the running rail must be bent carefully so that the pulleys of the bucket will be guided round the curve.

The curved ramps 5 and 6 consist of $7\frac{1}{2}"$ Flat Girders slightly curved and fixed in the positions shown in the illustration by $1\frac{1}{2}"$ Strips and $\frac{1}{2}" \times \frac{1}{2}"$ Angle Brackets. The exact curve will be found on trial when the model is completed.

Details of the Driving Unit

The motive power is derived from a Meccano High Voltage Electric Motor, but if such a Motor is not available a 6-volt Motor will answer as well. The vertical shaft 8 is driven by the Motor through the following gear train: A $\frac{1}{2}"$ Pinion on the armature spindle meshes with a 57-teeth Gear Wheel on a Rod that carries also a second $\frac{1}{2}"$ Pinion. The latter engages with a 57-teeth Gear on a Rod on which is mounted a Worm meshing with a 57-teeth Gear on the vertical Rod 8. This Rod is journalled in $7\frac{1}{2}"$ Angle Girders bolted across the vertical members of the frame, the bearings being reinforced by Double Arm Cranks secured to the Girders. Finally, the two 6" Pulleys 7 should be secured to the Rod.

The Motor is provided with automatic lubrication on the wick system. The oil is drawn up from an oil cup 69—a Chimney Adaptor—by lengths of worsted and conveyed thereby to the various working parts. The worsted is contained in lengths of Spring Cord, which is passed through Handrail Supports and clamped in the required position. For those who require further information on this method of lubrication, we would refer them to the "Suggestions Section" of the December, 1928, "M.M.," in which appeared full details of a wick lubricating system.

Little remains to be done to complete the operating station except the addition of the jockey

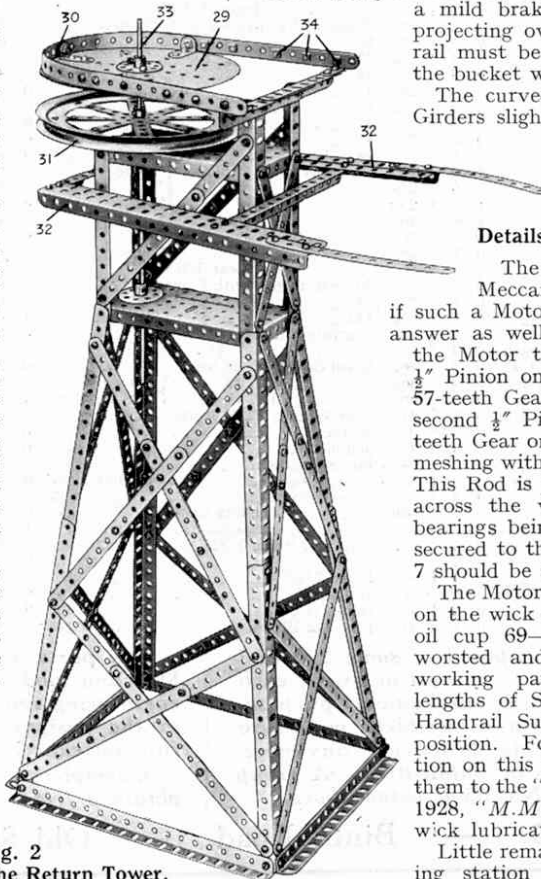

Fig. 2 The Return Tower.

pulley 9 and its weight, the guide pulleys 10 and 11, the strainers 12 and other details that are clearly apparent.

The guide pulley 10 is a $\frac{1}{2}$ " loose Pulley, mounted on a Pivot Bolt, which is attached to a $\frac{1}{2}$ " x $\frac{1}{2}$ " Angle Bracket bolted to the guard rail 3. The other guide pulley 11 consists of a 1" loose Pulley running freely between two Bush Wheels. The Rod carrying this arrangement is mounted in the boss of a Crank the end hole of which is secured to the guard rail.

The strainers 12 are of particularly neat construction and are eminently suitable for models other than the one under consideration. Each of these appliances consists essentially of two Cranks, through the bosses of which is passed a 1" Rod carrying a $\frac{1}{2}$ " loose Pulley. The ends of the Cranks are secured by bolts to each end of a Coupling. A $4\frac{1}{2}$ " Screwed Rod is passed through the centre hole of the Coupling and a Collar is secured to its top end to prevent it pulling out of the Coupling. The other end of the Rod works in the tapped bore of a Coupling that is secured to an 8" Rod placed across

passes through both Flanged Plates and is secured rigidly in position by Bush Wheels bolted to the Plates. Included in the assembly is also the 6" Pulley Wheel 31, which is placed boss downward and is free to turn on the Rod, three Washers being placed under its boss.

Each of the guard rails 32 consists of one $9\frac{1}{2}$ " Flat Girder and one $9\frac{1}{2}$ " Angle Girder. They are secured to a $7\frac{1}{2}$ " Angle Girder that is bolted across the tower in the position shown, and at the other end they are attached to Flanged Brackets, which are attached rigidly to the vertical $5\frac{1}{2}$ " Girders. The entering edge of the near guard rail is provided with a $5\frac{1}{2}$ " Curved Strip and that of the far guard rail with a $2\frac{1}{2}$ " large radius Curved Strip. The object of the Curved Strips (which are common to the guard rails of the other units of the model) is to lead the guide pulley of the bucket on to the rails without shock or possibility of derailment.

The Supporting Towers

We may now pay attention to the supporting towers. Fig. 1

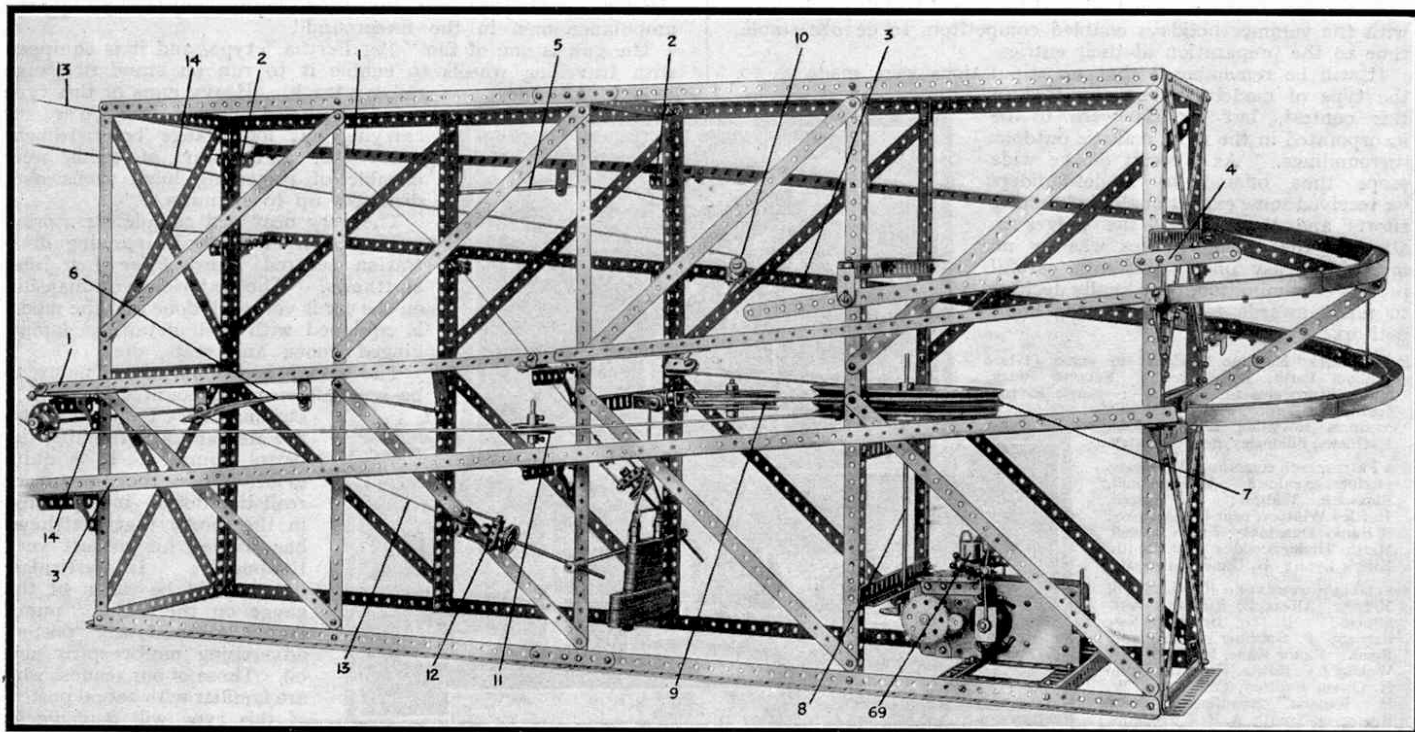

Fig. 3. The Operating Station, showing driving Motor, tensioning device on the hauling rope, and Strainers, etc.

the main frame. The other strainer is of course exactly similar.

Assembling the Return Tower

Having completed the operating station, attention should next be devoted to the construction of the return tower. This, as will be seen from Fig. 2, consists of a strongly built tower on the top of which is a 6" Pulley 31 for the hauling rope to pass round, and a semi-circular rail 30 on which the bucket runs.

The curved portion of the rail 30 is a $12\frac{1}{2}$ " Strip and it is bent carefully to the radius of a Circular Plate 29, to which it is secured by means of 1 " x $\frac{1}{2}$ " Angle Brackets; two Washers are placed on each bolt between the Strip and Angle Bracket. The straight portions of the rail are formed by $5\frac{1}{2}$ " Strips placed one on each side of the $12\frac{1}{2}$ " Strip, their free ends being attached to 1 " x $\frac{1}{2}$ " Angle Brackets. The latter are secured to a built-up girder 7 ins. in length, which is bolted across the top of the tower. The ends of the carrier rope will eventually be clamped between the $5\frac{1}{2}$ " Strips by means of the bolts 34.

The Circular Plate 29 is supported by an $11\frac{1}{2}$ " Rod 33, which

represents the tower that is seen in the general view next to the return tower. Nothing need be said as regards its general construction for that will be apparent by glancing at the illustration, so it is only necessary to draw attention to the more important details.

The carrier rope in the prototype is supported from the towers on what are known as "saddles." In the model the saddles are attached to the ends of the $12\frac{1}{2}$ " Girders forming the top of the tower, and each one consists of two $4\frac{1}{2}$ " Strips that are placed together face to face and separated by a Washer on each of the three bolts. The carrier rope will be passed under the centre bolt (which also serves to secure the saddle to its support), and over the two end ones. Thus the rope is free to move in its saddle.

The other tower shown in the illustration between the operating station and the automatic loading plant is exactly the same, in essentials, as that just described, with the exception that the saddle on the far side of the model is composed of a pair of $5\frac{1}{2}$ " Curved Strips, and the entering portion of the guard rail consists of a $4\frac{1}{2}$ " Strip and a $2\frac{1}{2}$ " Curved Strip bent parallel with the slope of the carrier rope.

(To be concluded)

Parts Required to build the Meccano Aerial Ropeway :

43 of No. 1	13 of No. 8	52 of No. 12	1 of No. 19b	1031 of No. 37	28 of No. 59	12 of No. 89	7 of No. 103k	1 of No. 125
22 " " 1a	32 " " 8a	10 " " 12b	3 " " 19c	6 " " 37b	14 " " 62	3 " " 89a	10 " " 108	2 " " 126a
32 " " 1b	26 " " 8b	2 " " 13	2 " " 20	36 " " 38	7 " " 62b	1 " " 90	3 " " 111	1 " " 127
32 " " 2	17 " " 9	2 " " 13a	6 " " 22	2 " " 46	9 " " 63	1 " " 90a	2 " " 111a	20 " " 131
60 " " 2a	10 " " 9a	1 " " 14	2 " " 22a	2 " " 48a	1 " " 63c	6' " " 94	12 " " 111c	6 " " 136
28 " " 3	2 " " 9b	1 " " 15a	7 " " 23	2 " " 52	1 " " 66	4 " " 96	2 " " 114	7 " " 139
5 " " 4	5 " " 9c	8 " " 16	10 " " 23a	6 " " 52a	3 " " 67	2 " " 102	1 " " 115	7 " " 139a
51 " " 5	8 " " 9d	7 " " 16a	5 " " 24	2 " " 53	6 " " 70	1 " " 103	1 " " 116	11 " " 147b
8 " " 6	3 " " 9e	2 " " 16b	1 " " 26	4 " " 53a	8 " " 72	5 " " 103a	1 " " 116a	1 " " 154a
3 " " 6a	10 " " 9f	3 " " 17	4 " " 27a	4 " " 54	5 " " 76	2 " " 103c	8 " " 119	1 " " 160
12 " " 7	24 " " 10	1 " " 18a	2 " " 30	1 " " 57	1 " " 80a	4 " " 103d	1 " " 120	2 " " 164
22 " " 7a	1 " " 11	3 " " 18b	2 " " 32	12" " 58	2 " " 80b	4 " " 103f		

2 Electric Motors. 30 ft. (approx.) of brass stranded picture wire. 40 ft. (approx.) of fairly thick string.

A Meccano Aerial Rope

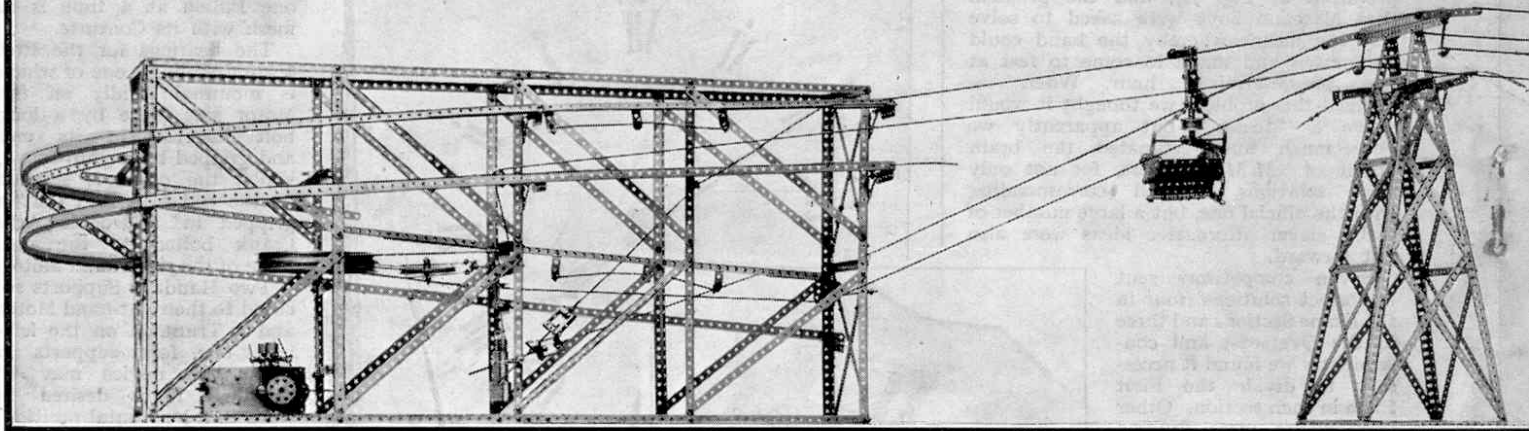

IN last month's "M.M." we described the construction of the starting station, return, and supporting towers of this fascinating model. In this instalment we give details of the bucket, tipping gear, and the automatic loading plant.

The bucket is shown in Fig. 5. The bucket proper consists of two $3\frac{1}{2}'' \times 2\frac{1}{2}''$ Flanged Plates, the ends of which are secured to $2\frac{1}{2}''$ Triangular Plates. A 2" Strip 15 and a 3" Curved Strip 16 are bolted to one end, so that the hinged Strip 17 may locate between the ends of the Strips 15 and 16, and thus maintain the bucket in a normally upright position. The bucket pivots freely on Pivot Bolts that are inserted in the lower holes of the containing frame 18 and secured to the bucket by double nuts. The catch 17 is attached pivotally to a Threaded Coupling 19 by means of a Pivot Bolt, inserted in the tapped bore of the Coupling.

The upper extremity of the containing frame consists of a pair of $4\frac{1}{2}''$ Strips, which are secured on each side of a Coupling by bolts, two Washers being placed on each of the bolts between the Strip and the Coupling for spacing purposes. A 5" Rod 25 is now pushed through the Coupling and through a Double Bracket at the bottom end of the $4\frac{1}{2}''$ Strips, and is secured in the transverse bore of the Threaded Coupling 19. Before finally securing the Rod in place, however, a Coupling and a Collar 26 should be placed on the Rod between the Double Bracket and the first Coupling. A Collar, two Flanged Wheels 20 (placed face to face), and three Washers, should also be mounted on that portion of the Rod between the Double Bracket and Threaded Coupling. The Flanged Wheels should, of course, turn quite easily.

On the second Coupling, which is free to slide on the Rod 25, a $\frac{1}{2}''$ loose Pulley 24 is mounted by means of a Pivot Bolt, which is locked by a nut in the transverse centre bore of the Coupling so that its shank does not touch the Rod. A Handrail Support is also secured to the Coupling on the opposite side. The runners consist of $\frac{1}{2}''$ fast Pulleys, mounted on Pivot Bolts, which are secured to opposite ends of a Double Arm Crank. The latter is attached pivotally to the fixed Coupling by means of a $\frac{3}{4}''$ Bolt, on which is placed a Collar between the boss of the Crank and the Coupling.

In the prototype the buckets are automatically disengaged from the hauling rope at the starting station, allowed to travel down the rails by gravity, and are re-attached to the hauling rope on the out-going side of the station. As this is an exclusive feature of a White ropeway, we went to much trouble to reproduce it in the model. It has been done quite successfully, but it was necessary

to resort to a certain amount of filing in order to produce parts of a certain shape that could not be attained otherwise with standard Meccano parts.

The fixed jaw of the gripper is a Simple Bell Crank 21, which is attached securely to one side of the containing frame 18. The moving jaw of the gripper (which is operated by the movement of the sliding Coupling through the medium of the link 23) is a 2" Strip, pivoted to the Simple Bell Crank by a lock-nutted bolt in the first hole from one end, and connected to the link 23 at the other. The latter end also carries a 25-gramme Weight, and the upper end of the link 23 (a $1\frac{1}{2}''$ Strip) is attached pivotally to the Handrail Support mounted on the sliding Coupling.

It may be seen fairly clearly from the illustration that a slot is filed in the Simple Bell Crank, and the top corner of the end of the Crank is filed to an angle of 45 degrees. The end of the pivoted jaw is also filed to a shape broadly resembling a V, so that normally the hauling rope is jammed by the movable jaw into the corner of the slot in the fixed jaw. This action is augmented by the effect of the 25-gramme Weight at the end of the movable jaw. When the Pulley 23 is raised to its fullest extent there should be sufficient gap between the fixed and moving jaws of the gripper to permit of the hauling rope being freed. The jaws should be carefully filed with this end in view, care being taken at the same time, however, to ensure that, when closed, the rope is gripped tightly.

As the jaws are separated by the thickness of the locknut of the fulcrum bolt from each other, it will be found necessary to bend the ends of the jaws closer together so that they may function efficiently. It is necessary to take some pains over the gripper, but the builder will be well repaid by the reliable working of the model.

The trip (Fig. 6) consists of a $4\frac{1}{2}''$ Strip, on either side of which are bolted Flat Trunnions, which are clamped to the carrier rope. A 1" loose Pulley is free to turn on a Pivot Bolt 35, on which are lock-nutted a Simple Bell Crank 36 and a $1\frac{1}{2}''$ Strip carrying a weight in the shape of a Collar 37. A guide 38 serves to maintain the device in correct relationship with the bucket by pressing against the bucket guide roller 20. The object of the Crank 36 is to prevent the hauling rope being pulled off the Pulley; the gripper of the bucket, in travelling to the left, strikes the furthest arm of the Crank and raises the one over which it has already passed, thus always keeping the hauling rope in place. The Crank is returned to its normal

Fig. 4. Main Hopper and Driving Gear of Bucket Conveyor.

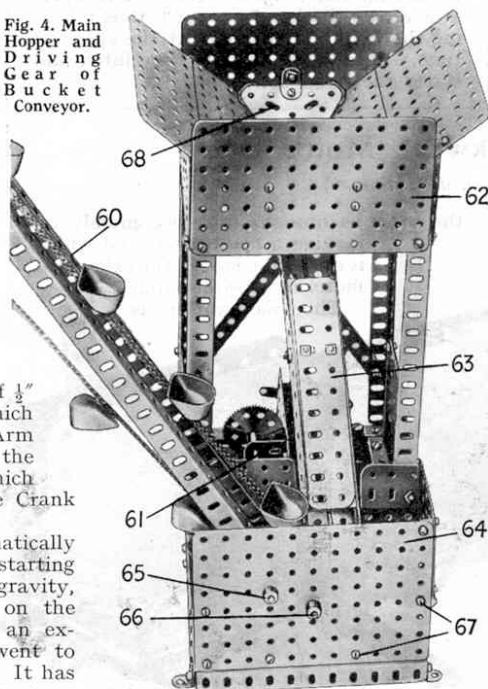

Ropeway with Automatic Pick-up and Discharging Gear.

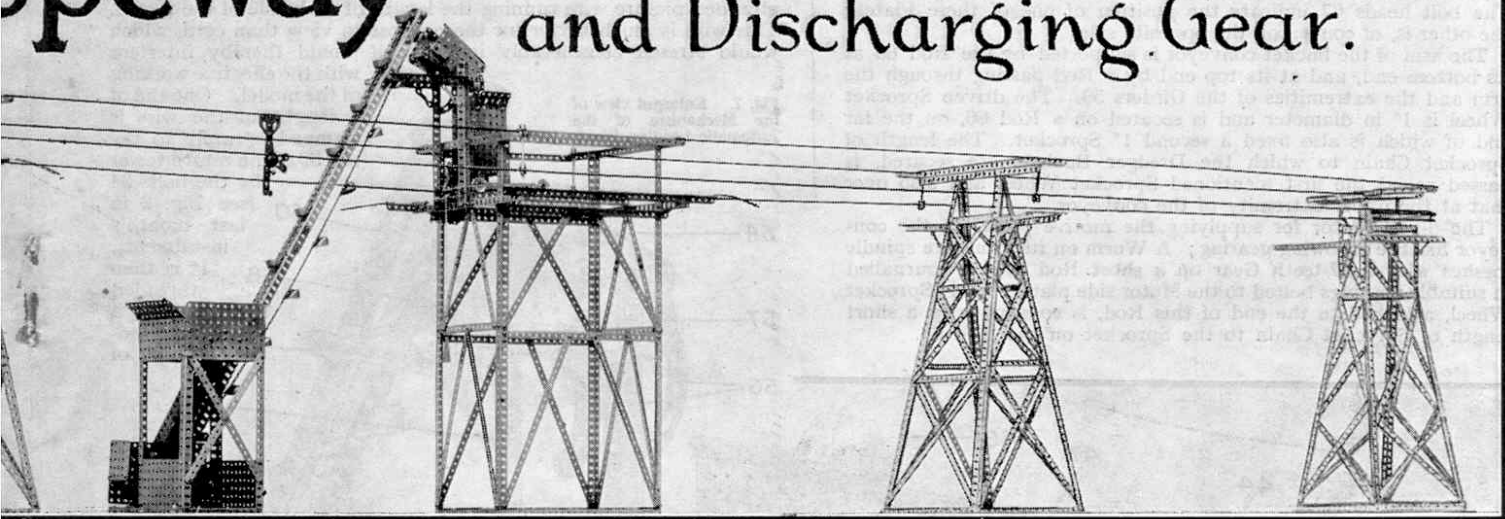

position by the weight of the Collar 39.

In the prototype the tipper may be placed anywhere on the system, with the result that the dumping ground may be shifted from time to time, but in the model its position has been fixed to enable the bucket to discharge its contents into the hopper of the automatic loading station, so that the operation of the model may be continued for any desired length of time. The discharge of the contents of the bucket is affected by the Buffer 39 on the bottom extremity of the $4\frac{1}{2}$ " Strip of the trip, engaging with a $\frac{1}{2}$ " \times $\frac{1}{2}$ " Angle Bracket on the catch 17 of the bucket. The catch is raised thereby, and since the bucket proper is in a state of unstable equilibrium, it cants sideways and discharges its contents. It is returned by the balance weights 28.

The Automatic Loading Plant

The automatic loading plant is perhaps one of the most interesting features of the model, for it is here that the material is discharged by a bucket conveyor into a hopper, which is in turn, discharged into the bucket of the ropeway. These operations are accomplished automatically without stopping or handling the bucket on the ropeway in any way, just as in the original apparatus—another patent feature of a White Ropeway.

By glancing at the general view of the model a fair idea of the chief constructional features of this portion of the apparatus may be obtained, but in order to get a better idea of the working details, it is necessary to refer to Figs. 4 and 7. We will take first Fig. 7. The bucket runs along the rails 44 (to which the carrier rope is clamped) and its guide roller 20 bears against the guide rail 43. Each of the rails 44 are attached by $1" \times \frac{1}{2}"$ Angle Brackets to the ends of $12\frac{1}{2}"$ Angle Girders 41 spanning the tops of the Girders 40. $\frac{3}{8}"$ Bolts serve to secure the rails to the $1" \times \frac{1}{2}"$ Angle Brackets, two Washers and a Flat Bracket being placed on each bolt. The Washers serve to space the rail from the Angle Bracket and the Flat Bracket is for the purpose of clamping the carrier rope in position.

Each of the guard rails 43 is secured to girders 42 in the manner shown. Each of the girders 42 consists of two $7\frac{1}{2}"$ Angle Girders overlapped two holes and care must be taken to see that the guard and running rails are the correct distance apart, so that the bucket may run easily.

The movable hopper 46 should be

constructed next. This is built up with $4\frac{1}{2}" \times 2\frac{1}{2}"$ Flat Plates for the sides, back, and the sloping bottom, and with two $2\frac{1}{2}" \times 2\frac{1}{2}"$ Flat Plates for the front, the lower one (49) of which is secured by a Hinge to the upper one, so that it may open outward. The sloping floor is a $4\frac{1}{2}" \times 2\frac{1}{2}"$ Flat Plate, as mentioned above, and is secured in place by $\frac{1}{2}" \times \frac{1}{2}"$ Angle Brackets, so that its rear edge is situated 1" below the top edge of the back plate. It is set at such an angle that its front portion coincides with the front bottom corners of the side plates, and from there it is prolonged

by a Sector Plate to form a chute, a second Sector Plate being placed over the first to keep the material from spilling. Two $2\frac{1}{2}" \times 1"$ Angle Strips are secured across the bottom of the hopper, short arms downward, and these in turn, are bolted to two parallel $5\frac{1}{2}"$ Angle Girders. In the latter are journalled axles carrying 1" fast Pulleys, which run on rails 45.

The tilting hopper 54, into which the bucket conveyor 60 discharges its contents, is composed of two Sector Plates, which are bolted to a $4\frac{1}{2}" \times 2\frac{1}{2}"$ Flat Plate, two $3\frac{1}{2}"$ Strips spacing each Sector Plate away from the Flat Plates, in order to give room for the hinged trap 57. The hopper is mounted freely on lock-nutted bolts that are journalled in the top holes of the $9\frac{1}{2}"$ Angle Girders 55, and 25-gramme Weights keep it normally in the position shown in the illustration.

Normally also the Weight 52 keeps the movable hopper to the right. Hence its edge bears against the 3" Curved Strips 56 and keeps the hopper 55 tilted, so that the contents of the latter may slide into it. The trap 49 is kept closed by a $2\frac{1}{2}" \times \frac{1}{2}"$ Double Angle Strip 48.

Now when the bucket reaches this portion of the apparatus (moving of course from right to left), it strikes the arm 50, which is secured rigidly to the movable hopper, and drags the latter along with it. As the hopper commences to move, the tilting hopper falls to a horizontal position, thus preventing any egress of the material, and the trap 49, freed from the Double Angle Strip 48, opens. This allows the bucket to fill. When the guide roller of the bucket reaches the ramp 53, the bucket is swung out of contact with the Strip 50. The hopper, thus freed, moves back under the influence of the Weight 52 and strikes the curved Strips, thereby allowing the accumulated contents of the tilting hopper to be shot into it.

The bottom end of the bucket conveyor is shown in Fig. 4, from which it may be gathered that the hopper into which the buckets discharge is simply constructed from Flat Plates 62. Two of its sides slope downward

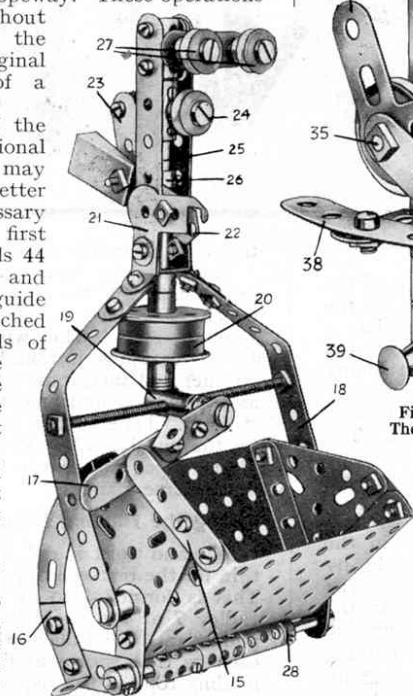

Fig. 5. The Bucket, showing Gripper and Catch.

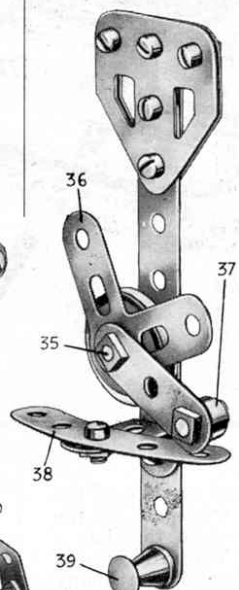

Fig. 6. The Trip.

toward the centre of the bottom, and a $2\frac{1}{2}$ " Triangular Plate 68 is secured at an angle to each of the remaining sides. A space is left open at the bottom and immediately under this is placed the chute 63. This is built up of Angle Girders and Flat Girders and terminates in a second hopper 64. Inside the latter are two $2\frac{1}{2}$ " x $2\frac{1}{2}$ " Flat Plates placed in such a way that the material may accumulate directly under the buckets of the conveyor. The bolt heads 67 indicate the position of one of these Plates; the other is, of course, on the opposite side.

The arm of the bucket conveyor is supported by the Rod 65 at its bottom end, and at its top end by a Rod passing through the arm and the extremities of the Girders 59. The driven Sprocket Wheel is 1" in diameter and is secured on a Rod 66, on the far end of which is also fixed a second 1" Sprocket. The length of Sprocket Chain to which the Dredger Buckets are secured, is passed round the first mentioned Sprocket Wheel and also over that at the upper extremity of the conveyor.

The 6-volt Motor for supplying the motive power to the conveyor has the following gearing; A Worm on its armature spindle meshes with a 57-teeth Gear on a short Rod that is journalled in suitable bearings bolted to the Motor side plates. A 1" Sprocket Wheel, attached to the end of this Rod, is connected by a short length of Sprocket Chain to the Sprocket on the Rod 66.

to the return tower, round which it passes to commence its homeward journey. Presently it reaches the trip and its contents are discharged into the hopper of the bucket conveyor. It then rights itself and is ready to repeat the cycle of operations.

The Attachment of the Carrier Rope

The carrier ropes each consist of two parallel lengths of brass stranded picture wire running the length of each side of the model. This wire is much better for the purpose in view than cord, which would stretch considerably in use and would thereby interfere with the effective working of the model. One end of a length of the wire is clamped securely to the rail 30 of the return tower

Fig. 7. Enlarged view of the Mechanism of the Automatic Loading Plant.

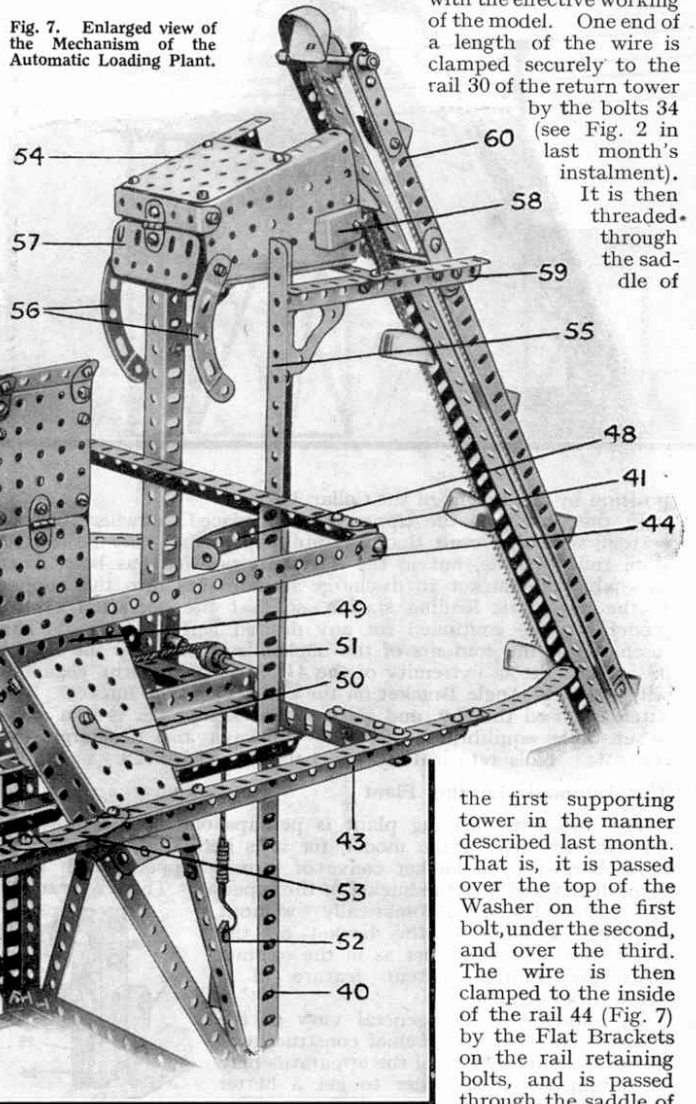

by the bolts 34 (see Fig. 2 in last month's instalment). It is then threaded through the saddle of

the first supporting tower in the manner described last month. That is, it is passed over the top of the Washer on the first bolt, under the second, and over the third. The wire is then clamped to the inside of the rail 44 (Fig. 7) by the Flat Brackets on the rail retaining bolts, and is passed through the saddle of the second supporting

tower in a similar manner to that adopted in the first.

The wire is then guided through the space between the underneath of the running rail 1 (Fig. 3) and a 3" Girder, which is secured by its slotted holes to the underside of the running rail. The wire is secured finally to the strainer 12 by wrapping it round the $\frac{1}{2}$ " loose Pulley on the end of the strainer and then round itself. This should be done very securely as the wire is under considerable tension when tightened by the strainer. (The carrier rope may be identified in the illustration by the number 13). We have only considered the fitting of one carrier rope; the one on the other side of the installation is treated in the same manner.

Fitting the Hauling Rope

Meccano Cord is not used for the hauling rope, since it is too thin for the bucket gripper to hold, but is replaced by thick string. This is formed into an endless belt passing round the driving Pulley 7 at the operating station, along each side of the model, and round the Pulley 31 on the return tower. Guide Pulleys, such as that shown at 61 in Fig. 7, are employed to retain the hauling rope in the required position on the various towers. The distances of the guides from the carrier rope should be carefully adjusted with the bucket in position.

(Continued on page 162)

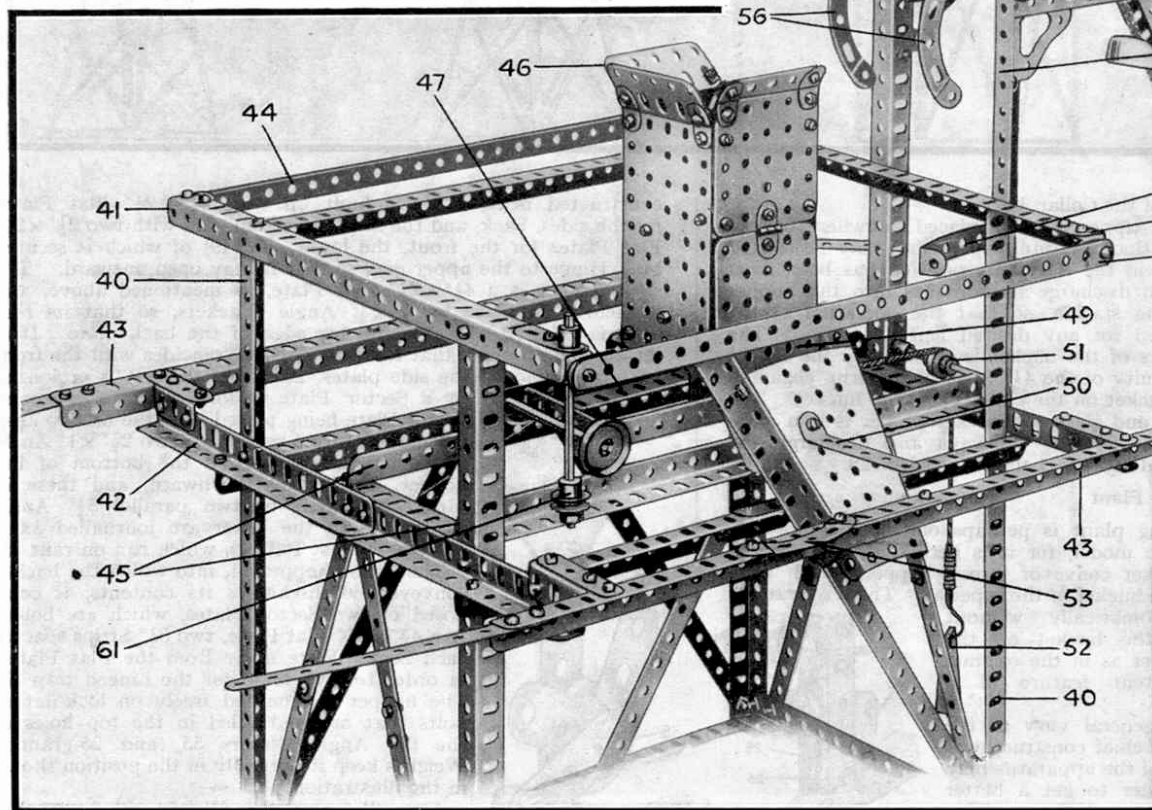

Completing the Model

As the various units are now complete, the final erection of the model may be proceeded with. First of all, the space at the disposal of the builder should be considered, since this has a bearing on the total length of the installation. The arrangement shown in the general view is 15 ft. long approximately, but many readers may prefer to make their model much longer. This may easily be done by adding more supporting towers, preferably between the automatic loading plant and the return tower. The various units should be screwed down by ordinary wood screws to a base (a long plank will do excellently) and the attachment of the carrier rope proceeded with.

It will be assumed for the purpose of making matters as clear as possible that the model is erected exactly as shown in the general view. That is, each unit is screwed down firmly by ordinary wood screws to a long plank in the order shown. The bucket should be assumed to be moving to the left from the position shown in the illustration. When it reaches the operating station it is dis-engaged from, and re-engaged with, the hauling rope in the manner described previously. It is then hauled up the steep slope of the out-going carrier rope, passed through the automatic loading plant, and along the entire length of the model

PRE-WAR—500 assorted Stamps, 6d.—Smith, 48, Belgrave Road, Ranmoor, Sheffield.

FREE. 50 Stamps to applicants for my cheap approvals.—Kenyon, 44, Granville Rd., Blackburn.

FREE. 100 Stamps to all approval applicants.—Knowles, 16, Withycombe Road, Exmouth, Devon.

100 Different Stamps Free. Send for 1/4d. approvals. Letters only.—Cox, 3, Mornington Mansions, Westcliff-on-Sea.

FREE! 20 diff. French Colonials to applicants for my low-priced approvals.—Caple, La Casita, Fownes Road, Alcombe, Minehead.

BRITISH COLONIALS. Ask to see my collection. 600 different on approval, all same price, 1/4d. each stamp.—Bickers, Lordswood Avenue, Southampton.

APPROVALS. Fine Range of attractive sets and singles at clearance prices. 10 Monaco or 12 Chili free, if postage 1/4d. is sent.—W. E. Williamson, 179, Gordon Road, London, S.E.15.

ST. HELENA PICTORIAL SET FREE

A new set of Stamps from this British Possession sent free of charge to bona-fide applicants for selections of duplicates on approval.

HENRY TURNER

110, Barnett Road, Preston, Brighton, Sussex.

GENUINE BARGAIN PACKET

No. 586. Post Free 3d. Contains 110 different Stamps, including Monaco, Kedah, Iraq, Malta, Siam, Angola, S. Rhodesia, Upper Volta, Ecuador, etc., etc., and all purchasers who ask for approval sheets receive 4 NEWFOUNDLAND FREE.

New Approval Sheets ready. Grand variety. Good Discount. Write for a selection to-day. Duplicates exchanged. Exchange desired with all Colonies. F. G. ROWE, 63, EDGEHILL RD., BOURNEMOUTH.

U.S.A.

The current issue, very fine used.

1/4c. to 13c. and 17c. Various Presidents' Portraits, etc. 14c. Indian, 15c. Statue, 20c. Golden Gate, 25c. Niagara Falls, 30c. Bison, 50c. Amphitheatre, 1/2 Lincoln Memorial. The set complete 2/- (postage extra).

The Month's Stamp News.

My useful Monthly List is post free and tells of many other fine offers.

GEORGE LAZENBY,

16, Redburn Drive, Shipley, Yorks.

YOUR OPPORTUNITY AND THERE IS NO SNAG IN IT. £25 IN CASH PRIZES.

We are celebrating our Jubilee year by giving away £26 in 62 cash prizes to the buyers responsible for effecting the greatest number of stamps sold from our world famed approval sheets during the year 1930. **FIRST PRIZE £10 BANK OF ENGLAND NOTE.** Full particulars and a set of Siamese Stamps sent absolutely FREE on receipt of your name and address by

Department 33,

Errington & Martin, South Hackney, London, E.9. Established 1880.

ALL APPROVALS HALF-PRICE

Dozens of Approval Sheets of Colonial and Foreign, including old and new issues all to be cleared at half marked prices. Plenty of bargains from 1/4d. upwards. List of free gifts sent with approvals.

50 British Colonials free to first 20 applicants.

MISS M. SAUNDERS,

16, KENT ROAD, EAST MOLESEY, SURREY.

Have You Seen Them?

MY RECORD APPROVALS.

Huge discount of 8d. in 1/- allowed, or 9d. in 1/- for a nett purchase of 2/6 or more. My approvals being absolutely the cheapest and best, no free gifts are given.

RECORD STAMP COMPANY,
23, Canning Road, East Croydon.

"MECCANO MAGAZINE" BINDERS

Your Magazines may be kept clean and tidy by enclosing them in one of the special binders we supply. Two sizes, price 3/- and 4/6 post free, from Meccano Ltd., Old Swan, Liverpool.

OUR CRICKET BAT CONTEST

It is very evident from the steady flow of entries that has been reaching us during the past few days that our cricketing readers do not intend lack of effort to be their excuse for failure to win the autographed cricket bat that is the principal prize in this contest. The fact that only one reader can win the bat must not deter any would-be competitor from making his attempt. There are dozens of consolation prizes to be won, and each of these is well worth having.

For the benefit of new readers we must explain that during their visit to Liverpool last summer to play the Lancashire County Cricket XI, the South African Cricket tourists visited the Meccano factory, and, at the request of the Editor, autographed a specially-chosen cricket bat for presentation as a prize in an "M.M." contest. Subsequently the bat was autographed by the Lancashire XI, and also by Mr. Frank H. Smy,

inventor of Meccano and Managing Director of Meccano Limited.

Full details of the bat and the competition that is being held to decide which Meccano boy shall become the fortunate owner, were given on page 955 of the December "M.M." There is still time to take part, for the closing date is not until 31st March. Competitors are not required to rely upon their own unaided efforts; they may enlist the help of parents, uncles, cousins and friends. We are looking forward to a bumper entry, and in the meantime the bat, together with a photograph of the South African team, taken on the occasion of their visit to the factory, will be on view in the windows of prominent Meccano dealers in various parts of the country.

During February 1930, the bat is on view as follows:—

4th to 8th Feb. ... J. Robertson, 94, Northumberland Street, Newcastle-on-Tyne.
11th to 15th Feb. ... R. Scupham & Sons, 35, Linthorpe Road, Middlesbrough.
18th to 22nd Feb. ... Saxon's (Sunderland) Ltd., 29, Holmside, Sunderland.
25th Feb. to 1st March ... A. Lascelles, 90, Northgate, Darlington.

How to Get More Fun—(Continued from page 147)

of a locomotive to be changed by reversing the current it is necessary to use a motor having a permanent magnet instead of an electro-magnet, for then the direction of the magnetic field is fixed. The advantages of being able to reverse a locomotive as well as to vary its speed by means of a controller are so great that a special locomotive of this kind has now been introduced into the Hornby system. This is known as the No. 1 Permanent Magnet Tank Locomotive. It may be operated only from a 6-volt accumulator.

The resistance controller used for this locomotive has two levers, one of which is used for varying the speed of the locomotive and the other for changing its direction. Fig. 2 shows how the connections to it and the track are made. From the positive terminal of the accumulator connection is made through the controllers to the centre rail 2 by means of wires 8 and 6 and the connecting plate, which is secured by key 3. The return current is carried by means of the wires 7 and 9. Speed is controlled by means of the lever 10, while the direction of the locomotive is governed by the position of the lever 11.

Opportunity for Meccano Boys

In next month's issue we hope to announce a very interesting competition that we are organising with the co-operation of R. A. Lister & Co. Ltd., of Dursley, Glos., and in which valuable prizes will be offered for the best Meccano models of the petrol-driven Lister Auto-truck. Meccano boys who are able to visit the British Industries Fair at Olympia, London, W., can inspect the actual truck at the Lister Stand (No. 1, Block 17G).

Modelling for Scouts

Messrs. Harbutt's Plasticine, of Bathampton, Bath, send us a splendidly illustrated booklet "Plasticine for Scouts and Guides," dealing with the multifarious uses to which Plasticine may be put in the training and camp life of Scouts, Cubs, Guides and Brownies.

The interesting feature of the booklet is that it is compiled solely from the experience of members of the Scout and Guide Organisations, and many highly interesting and novel suggestions are made for the benefit of those seeking novel ways of training boys and girls to use their natural powers of observation.

How to get the booklet is fully explained in Messrs. Harbutt's advertisement on page 175.

A Meccano Aerial Ropeway

(Continued from page 134)

so that the gripper does not foul any of them. After a little experiment the correct adjustment will soon be found.

Fig. 3 should now be consulted. This illustration shows the far side of the operating station to that in the general view, and the hauling rope may be identified by the number 14. First taking the far side of the station (in Fig. 3), the hauling rope passes over the guide Pulley 10 and also round a second guide Pulley. From here it is passed round the upper 6" Pulley 7, rove through the jockey Pulley 9, round the second 6" Pulley, over the guide Pulley 11, and finally leaves the station via another guide Pulley. This, it may be mentioned in passing, comprises a 1/2" loose Pulley, retained on an 11 1/2" Rod by a Bush Wheel and a Collar.

The object of the jockey Pulley is, of course, to keep the hauling rope taut. It consists essentially of a 3" Pulley secured on a short Rod, which is journalled in two 2 1/2" Strips. The latter are bolted securely to a Fork Piece, to which the cord from the weight is attached.

We may now effect the final small but important adjustments. The first that should be attended to is the adjustment of the ramp 5 that effects the disengagement of the buckets from the hauling rope. It will be evident that this is effected by the 1/2" Pulley 23 of the gripper riding up the slope of the ramp 5, thereby opening the jaws of the gripper and releasing the hauling rope. The important point to grasp is that if the slope of the ramp be too abrupt the bucket, when released, will stop. Hence it is necessary to arrange matters so that the ramp has a smooth and gentle curve. The same applies to the ramp 6.

Another point requiring attention is the position of the guide Pulley 11. This must be adjusted so that when the jaws of the gripper are opened by the ramp, the hauling rope springs into the open jaws, when it is immediately clamped by the closing of the jaws.

Dried peas will be found suitable as the material to be transported. Sand or similar fine substances should not be employed.

1,000 PACKET A WONDERFUL OFFER

of stamp bargains. Price 4 1/4d., postage 2 1/4d. extra, abroad 6d. extra. In addition, free sets will be sent to those who send names of stamp collecting friends. Ask for my famous approvals.

The "1,000 Packet" contains 500 excellently assorted Stamps, a COMPLETE SHEET of 100 UNUSED (very useful for exchange purposes); a neat 12-page booklet for holding duplicates; 25 British Colonials, usually sold at 1/4d. to 1d. each, including new and obsolete issues; 375 Magic "Strip" Mounts, and my price list.

H. C. WATKINS, M. Dept., Granville Road, BARNET.