

APRIL 1925

MECCANO MAGAZINE

PRICE
3^D
VOL. X
NO. 4

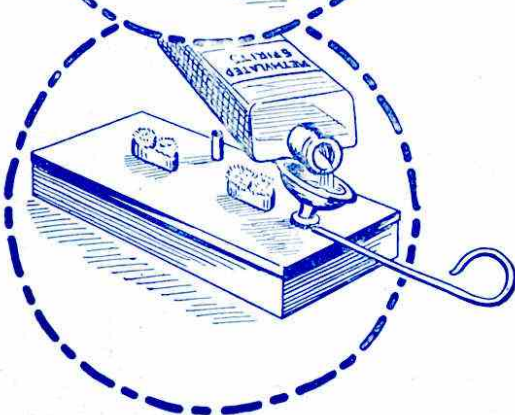

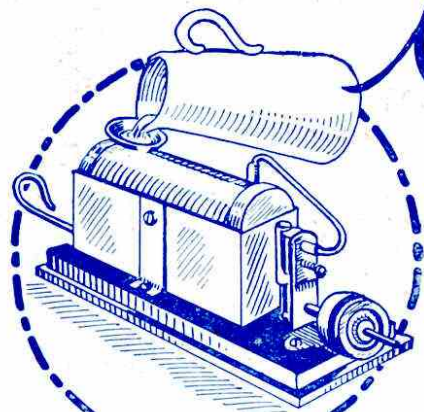

Water and 'meth'—
and away she goes!

*British Model Launches
made for
Speed, Service, Beauty*

Here's a lovely Launch for you—one of which you will be proud and the other boys envious. She has a real engine which generates a nice turn of speed and keeps the boat going for 20 or 25 minutes with one filling. You can't get such splendid value anywhere else—it beats the German boats hollow.

Hours of joy for any boy!

MISS AMERICA

Painted three colours enamel, totally enclosed firebox, well-made brass boiler, engine, and twin bladed propeller. Power to drive 20 minutes.

12'6

31 inches Long.

3½ inch Beam.

Post 9d. extra.

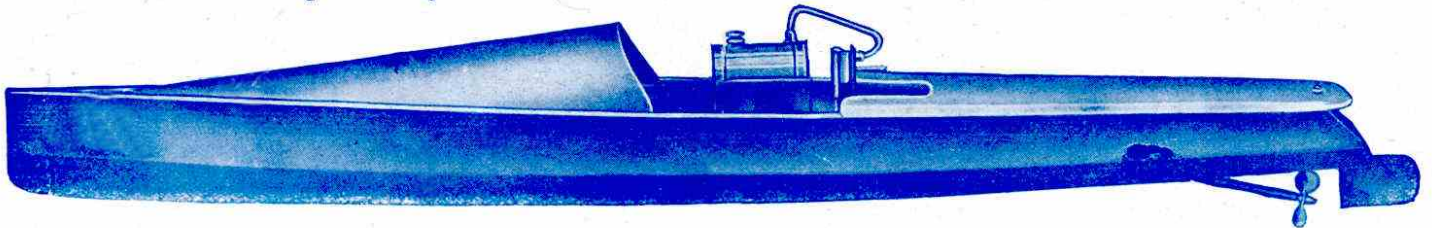

PEGGY

A Boat of superlative strength and beauty. The larger power unit gives greater driving energy, and keeps the boat at good speed for over 25 minutes to cover a mile on the straight at one filling. The "tuff-tuff" of the steam carried out astern is a delightful piece of realism.

22'6

32½ inches Long. 3½ inch Beam.

Post 9d. extra.

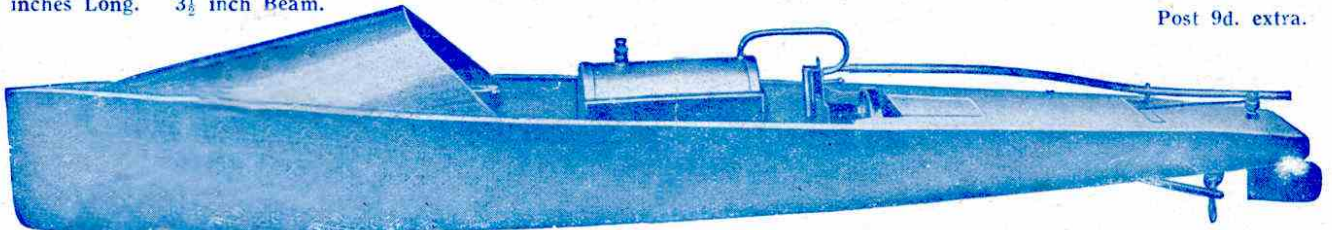

**FREE TO ANY
MECCANO BOY**

Every reader of Meccano Magazine should write for free lists giving full details of these Launches. Write to Peggy Dept., or if you live near a Branch call for the lists there.

You can order
safely by post

**WHERE
YOU CAN
BUY THEM**

Hobbies Ltd. (Miss America Department, Dereham, Norfolk

Or from Hobbies Branches at London, Glasgow, Manchester, Birmingham, Leeds, Southampton, Brighton or Sheffield. From most good stores and sports houses and the usual Hobbies Agencies. Also at 45, Colborne St., Toronto, Canada.

EDITORIAL OFFICE

Binns Road.

LIVERPOOL

Vol. X, No. 4

MECCANO MAGAZINE



PUBLISHED

IN THE INTERESTS

OF BOYS

April 1925



EDITORIAL

THOSE of our readers who order the "M.M." from newsagents outside London may experience some difficulty this next month or two in obtaining their copies. This is on account of the fact that certain wholesale newsagents in the provinces have decided to discontinue handling the Magazine for reasons that I need not enter into here. These wholesale firms supply the retail newsagents from whom the Magazine is obtained by a number of our readers. If any reader has any difficulty in this connection I shall be glad if he will ask his newsagent to write to me on the matter, and I shall be pleased to arrange for supplies of the Magazine to be sent to any newsagent who may be unable to obtain them through the usual channels. This does not apply to London newsagents, nor to newsagents in Scotland and Ireland, as our connection with the wholesale firms in these districts remains unbroken. The "M.M." may, of course, be obtained from any Meccano dealer and as there is a Meccano dealer in practically every town there should be no difficulty whatever in every reader obtaining his magazine regularly, from one source or the other.

Our next month's issue will contain several attractive features, including a very interesting article dealing with the shipping of locomotives overseas in vessels specially designed for the purpose. This matter will also form the subject of the coloured cover, which is now being prepared by our artists. The instalment of "Lives of Famous Engineers" will deal with I. K. Brunel's connection with the G.W. Railway and will be of particular interest to those of our readers who are keen on matters connected with railways. No doubt many readers will know that for a considerable period the G.W. Railway used a wide-gauge line and even continued to use this in spite of the fact that all other railway companies in this country found the narrower and present gauge more serviceable. The fact that the

Next Month

gauge of the G.W. rails differed from that of other companies meant, of course, that their locomotives and rolling stock could not be used on any other line, nor, for the same reason, could the rolling stock of other companies be used on the G.W. lines. Our article will describe the advantages of the broad gauge track and will also deal with the conversion of the G.W. track from its original gauge to the present standard gauge.

In our May issue we shall describe a very neat and interesting new Meccano model of Platform Weighing Scales.

Get Out Your Cameras

These scales will actually weigh and the model, if carefully made, is capable of giving very accurate results.

In the present issue we commence a new feature, the "Photographic Page" which I feel sure will be appreciated by thousands of our readers. The Photographic Competitions in the past have been among the most successful of all of the Competitions I have arranged, and I look forward to an increased number of entries in the competition announced in this issue. Future Photographic articles will take our readers through the whole process of exposing, developing, and printing and the various methods and different processes will be described in detail, to enable our readers to experiment for themselves, if they feel so inclined. There will be a number of other interesting articles in our May issue and our regular features will, of course, be included also.

By the time this issue is in the hands of our readers they will no doubt be anticipating the impending holidays and making their plans to spend Easter under the best conditions. Of course, a great deal depends upon the weather, which at this time of the year is somewhat unsettled. Whatever the weather may be, however, it does not matter to the Meccano boy. If it is fine he is out in the open air actively enjoying himself either walking, cycling, or doing one of a dozen other things, the names of which end in "-ing,"—an ending, I remember, that always implies motion! If it is wet, Meccano boys are busily employed indoors inventing new models, or improving existing models. Those who possess Hornby Trains find even greater pleasure at hand in laying out their track and running a miniature railway of their own. There is so much to do at Easter, either indoors or out, that we very often forget the many beautiful and interesting things that are

The Coming Holidays

associated with this time of the year. For instance, I wonder how many people remember that Easter is a religious festival of great antiquity and that at this date the Romans kindled the sacred fire in the Temple of Vesta every year, which act signified the commencement of the Roman year.

In many other countries, too, the dawn of the new year and the end of the reign of winter was celebrated at Easter. All over the land bonfires were lighted from the sacred flame kindled by the priests on Easter Eve. This custom is carried out even to-day in many parts of Europe, particularly in Germany where the bonfires are kindled year after year on the same hills, called for that reason "Easter Mountain." The peasants believe that only those fields that are reached by the light of the bonfires will be fruitful during the ensuing year. When the fires die down everyone—including even the children—leaps over the dying embers, and often the cattle are driven through them as a protection against disease! In the old days Easter was also celebrated by a general merry-making, which included games, songs, dances, theatrical performances and so on. The cakes that were made for these special occasions were the fore-runners of our "hot-cross-buns" and Simnel Cakes. The Middle Ages saw the introduction of the custom of presenting brightly-painted eggs to friends—a custom that survives to-day, but in most parts of the country chocolate eggs are given. In parts of Northumberland and Durham ordinary hens' eggs are boiled in brightly coloured dyes and painted with grotesque patterns. On Easter day all the children may be seen going to the different parks or the fields, each taking their eggs, which are rolled and tossed about until they break, when the contents are eaten by their owners. As the eggs are boiled as hard as possible they sometimes stand a good deal of knocking about, but occasionally some practical joker substitutes for his friend's egg an egg that has scarcely been boiled at all. This naturally causes a bewildering surprise to the owner of the egg, and the results—which can easily be imagined—sometimes occasion a great deal of fun!

Strange Easter Customs

Change of Address

Change of Address

Subscribers should immediately notify the Editor of any change of address. Send a Postcard giving the old and new address, so that records may be kept up-to-date.

New Baltic Tank Locos

Notable Additions to the L.M.S.

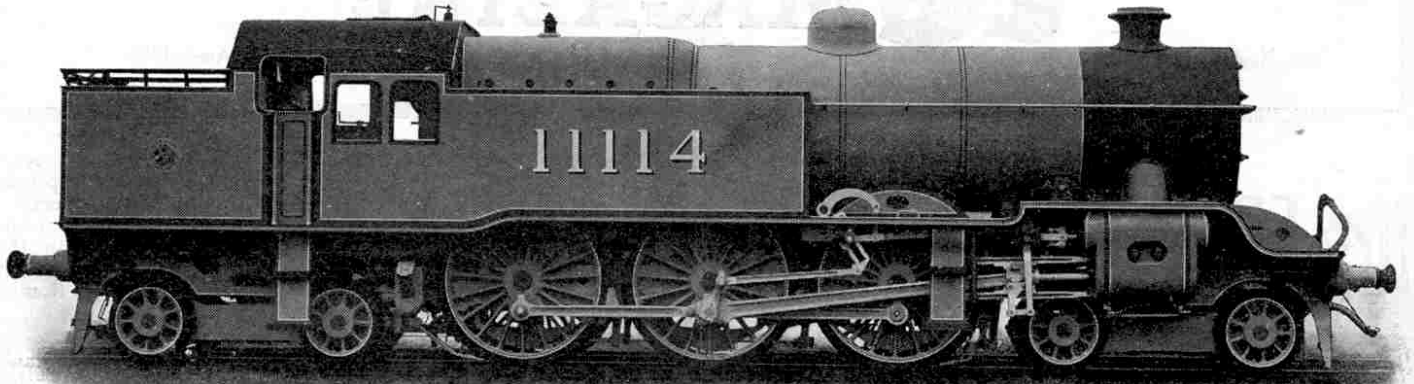

Photo courtesy]

Four-cylinder "Baltic" Express Tank Engine (4-6-4) No. 11114, built 1924

[L.M.S. Rly. Co.]

AS every reader of the "M.M." knows, considerable economy in running costs is effected by the employment of tank engines, as compared with tender engines. This applies more particularly, of course, on comparatively short runs, where smaller quantities of water and coal are necessary for each trip. A tank engine has the further advantage that it may be run as readily backwards as it is run forwards, a fact that enables it to be used independently of turntables, thus effecting yet further economy in both time and money.

The Only Four-Cylinder Tank Locos

These considerations have no doubt had a good deal to do with the recent development of this type of loco, and the consequent design of a new and unusually powerful type known as the "Baltic" (4-6-4). Some of the locos of this type not only carry tanks having a water capacity of 2,000 gallons, but are also fitted with water-scoops for picking up whilst running in either direction. They are thus able to travel a considerable non-stop distance over routes where water troughs are placed between the rails, the length of the run being limited only by the capacity of the coal bunker, which in many types is as much as 3½ tons.

Several of these "Baltic" tank engines designed to haul heavy suburban passenger trains, have recently been added to the rolling stock of the London, Midland and Scottish Railway. Built to the designs of Mr. George Hughes, chief engineer to the Company, these locos are the largest of their class, and are the only four-cylinder tank engines in the country. Already several have been completed at the L.M.S. works at Horwich and will replace the 4-6-0 tender engines now working the heavy residential traffic on the Western Division, such as is found on the routes linking Manchester with Blackpool, Southport, and Buxton.

We reproduce a photograph of the four-cylinder L.M.S. "Baltic" No. 11114, the fifth of this class to be built. A careful study of the illustration reveals a striking similarity to the Horwich-built 4-6-0 express tender locos. As a matter of fact, the loco is in many particulars a replica of the 4-6-0 type locos, but with an extended frame at the rear end to carry the coal-bunker and an additional bogie.

Loco Standardisation

Efforts have been made to standardise these two types of locomotives as far as possible, with the result that the boilers, "motions," and "front ends" of each type are interchangeable. This standardisation, or interchangeability of parts, is in accordance with the general trend of modern industry, for the numerous advantages of such methods are almost daily being discovered in all big manufacturing operations. Low cost and greater rapidity of production; economy in machining costs; quicker and less costly repairs whilst running, resulting in a consequently lower maintenance expense; and ease in assembling are a few of the ends achieved by applying mass-production methods to railway locomotive construction.

Every boy who owns a Hornby Train already knows something about the advantages of interchangeability, so it is quite unnecessary for us to enlarge upon the merits of standardised parts.

The L.M.S. Baltic engines are fitted with a "top and bottom" header superheater, designed by Mr. Geo. Hughes, of the L.M.S., in which separate cast-iron headers are provided for saturated and superheated steam. The advantage of this type of superheater is that the saturated steam is not allowed to exert a cooling effect on the superheated steam, which may happen when both are in the same header. The steam passages throughout have been kept as short and direct as possible thus ensuring a minimum of wasted power.

Patent Pressure-Release Valves

One of the most interesting features of the L.M.S. "Baltics" is Mr. Hughes's patent pressure-release valves, incorporated in the piston valves. These patent valves are designed to relieve excessive pressure within the cylinder caused by trapped steam, air or water.

In high-speed running, as well as in running with steam off, the excess steam or air compression is liable to become very great. Sometimes this causes "knocking" at the cross-heads, or in more serious cases may even result in fractured cylinder-covers and burst joints.

Those of our readers who possess a bicycle-pump must have noticed that if they extend the plunger and then place a finger over the outlet, it is impossible to force the plunger back to its original position, owing to the "air-cushion" formed within the inflator. Practically the same thing happens in the cylinder of a locomotive when running with steam shut off, and the opposition of trapped air to an advancing piston is one of the evils that the new ball release valve is designed to eliminate. The valves are so arranged that the moment the pressure in the cylinder exceeds that in the steam chest, they automatically open an outlet between the latter and the cylinder.

How the Valves Work

The operation of the valve is quite simple and may be easily followed with the help of the accompanying sectional diagram (Fig. 1) which shows the ball release valves set in the piston valve.

The valve (A) is in the exhaust position and steam is about to be admitted at the other end of the cylinder (not shown in our diagram). Whilst the loco is running normally under steam the ball valves (C) are held against their seatings by the pressure in the steam chest, which pressure naturally exceeds that in the cylinder. Now supposing that the loco is "coasting" with steam cut off. A little more than half-way through the piston stroke the valve "A" closes the cylinder port, with the result that air is trapped before the oncoming piston, and subjected to great pressure—or rather, that would be the case were it not for the action of the ball valves. The air, under pressure, rushes through channels (B) in the periphery of the piston valve (A) and escapes into the steam chest by throwing the balls (C) off their seatings, for the steam chest pressure is no longer sufficient to hold them there when the steam supply is cut off. The same process prevents excess compression of steam during high-speed running and water-logging in the cylinder, as already stated.

Loco Weighs 100 Tons

The principal dimensions of the new L.M.S. "Baltics" are as follows: Cylinders (four, single expansion): 16½ in. by 26 in. Length of boiler between tube plates: 14 ft. 8 in. Grate area: 29.6 sq. ft. Boiler heating

surface: 1997 sq. ft. Superheater surface: 430 sq. ft. Working pressure, 180 lbs. per sq. in. The driving wheels have a diameter of 6 ft. 3 in., and the bogie wheels 3 ft. 0¾ in.

At 85 per cent. of the boiler pressure the engine exerts a tractive effort of 28,879 lbs., and in working order weighs only 3 cwt. short of 100 tons.

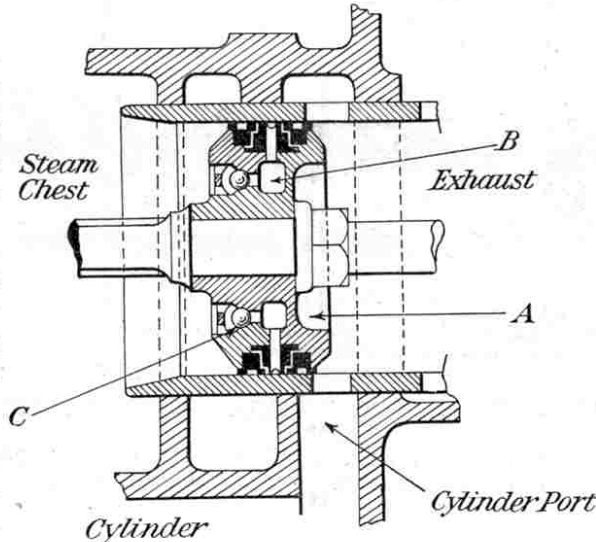

Fig. 1. The Patent Pressure Release Valves fitted to the Piston Valves of the new L.M.S. "Baltic" Locomotives

The Trial Trip of No. 11110

Ten of these locos. will be constructed at Horwich and their numbers are to be 11110-11119. The first "Baltic" to be completed (No. 11110) ran with notable steadiness on its trial run and notwithstanding its long wheel-base (40 ft. 4 in.) it was able to negotiate with ease curves of 4 chain radius. The trial took place between Bolton and Hellifield on a stretch of line that is particularly severe. The load was 10 bogie coaches and dynamometer car, representing a net weight behind the drawbar of 304 tons. During the run the engine showed up to advantage, negotiating the six miles of 1 in 72 and 1 in 74 from Astley Bridge to Spring Vale tunnel on the outward run in 11 mins. 50 secs. without being pushed in any way, the cut-off being in the neighbourhood of 35 per cent. and the regulator being approximately half open. On the inward run the distance of 6½ miles up the reverse side of the same bank from Blackburn to Spring Vale tunnel, running bunker first, was covered in 12 mins. 35 secs. from a standing start at Blackburn. A speed of 58 miles an hour was attained between Newsholme and Hellifield, and it was noticed that the engine rode most smoothly; in fact, all through its trials it has shown a remarkable freedom from oscillation, and ability to take curves.

Origin of the name "Baltic"

The word "Baltic," as applied to a locomotive wheel arrangement, is one of the few such designations that have not come to us from America, and its origin is a little obscure. The L.M.S. Company tell us that to the best of their knowledge the name was first applied to the 4-6-6 Tender Engines built for the Nord Railway of France about 1912. Only two engines of this class have been built and they remain the sole examples of the "Baltic" Tender Engine in the world, even to-day.

Strictly speaking, the names describing a wheel arrangement such as "Atlantic," "Pacific," "Baltic" should only apply to tender engines, and it will be found that neither 4-4-2 nor 4-6-2 Tank engines are ever referred to by the terms "Atlantic" and "Pacific." For some unknown reason, however, this rule has been broken in the case of the 4-6-4 Tank engine, and the word "Baltic" has become the accepted title for this type.

The "Baltic" wheel arrangement is practically unknown in America, whether for tender or tank engines, and it is refreshing to find something in this line which was not done in America first. The "Baltic" tank

(Continued on page 183)

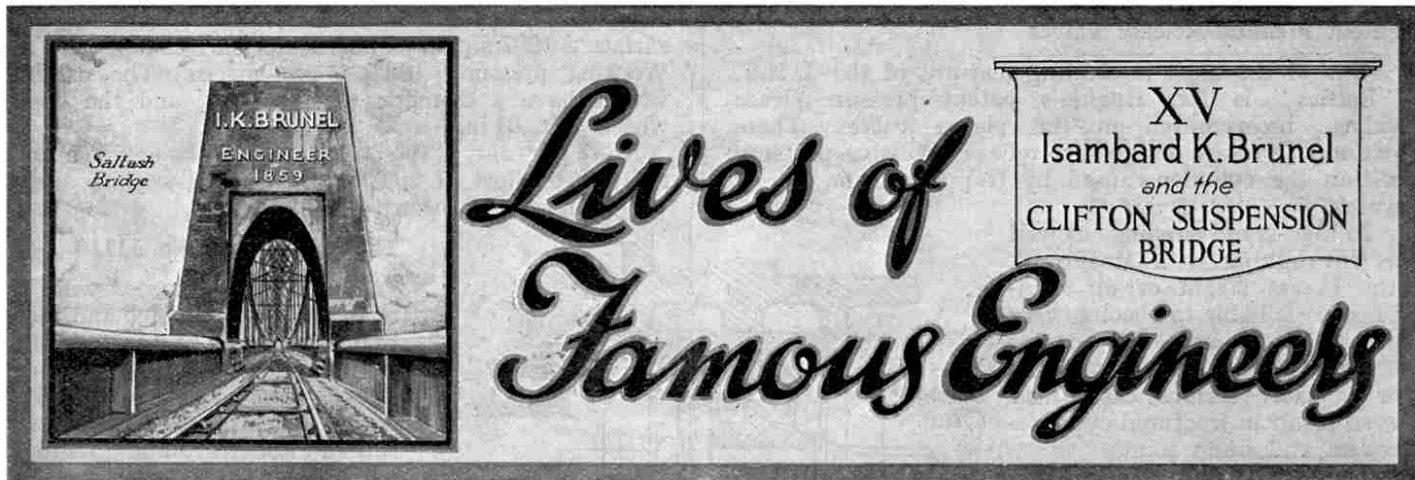

Last month we completed our account of the life of Sir Marc Isambard Brunel, and now we must turn to the remarkable engineering career of his only son, I. K. Brunel, remembered chiefly for his association with the Great Western Railway and the "Battle of the Gauges." He was a pioneer of steam navigation and his work in this connection culminated in the building of the famous "Great Eastern."

ISAMBARD KINGDOM BRUNEL was born at Portsmouth on 9th April, 1806. Shortly afterwards Sir Marc removed to London, and took a house in Lindsay Road, Chelsea. Young Brunel's first recollections were of this house and in 1814, when he was eight years of age, he commenced his education at a private school in the neighbourhood of his home. Later he was sent to another private school at Hove, where he soon began to show signs that he had inherited his father's engineering genius.

An interesting story is told of him at this time. He had been keenly interested in watching the erection of some houses opposite the school and he had noticed that the building was being very badly done. One day wild weather set in, and towards night the wind became so violent that Brunel felt convinced that the badly built walls of the houses would not be able to withstand the strain. Accordingly he made a bet with his school mates that the walls would fall before morning and he won his bet, for the buildings collapsed during the night.

In 1820 Brunel went to Paris to study at the College Henri Quatre, mainly for the purpose of improving himself in mathematics and brushing-up his French. He remained at Paris until the middle of 1822, and during this period he occupied all his holiday intervals in visiting as many engineering works as possible. He sent drawings and descriptions of all of them to his father.

Commences his Engineering Career

Brunel returned to England and in 1823 he entered his father's office as assistant engineer. At that time Sir Marc was turning his attention seriously to the Thames Tunnel scheme. When work commenced on this gigantic undertaking Brunel took his share in the operations and up to 1828, when work was stopped

by an irruption of the river, he toiled unceasingly along with his father. In this work he displayed great engineering skill and inventiveness, together with remarkable powers of physical endurance. The story of the Thames Tunnel has already been told in our issue last month, so that there is no need to say anything further about it or the part Isambard played in the successful completion of the work.



Isambard Kingdom Brunel

For nearly two years after work on the Thames Tunnel had come to a standstill Brunel was without regular professional work. During that time he employed himself in scientific research, in which he associated himself with Faraday and others. In the autumn of 1829 he heard that designs were required for a suspension bridge across the River Avon at Bristol and he immediately made up his mind to compete

Clifton Bridge Competition

The bridge scheme originated in 1753, when Alderman William Vick bequeathed £1,000 to the Society of Merchant Venturers of Bristol with instructions that the money was to accumulate at compound interest until it reached £10,000, when it was to be used for the erection of a stone bridge across the Avon from Clifton Down to Leigh Down. By 1829 the accumulated money amounted to nearly £8,000, and a committee was appointed to consider the best method of carrying out Alderman Vick's wishes. The idea of a stone bridge was soon abandoned, however, for an estimate that was obtained put the cost at £90,000. The committee then advertised for designs for a suspension bridge.

Brunel's plans

Brunel promptly went to Bristol to examine the locality, and selecting four different sites within the limits laid down by the committee he sent in a separate design for each site. The first design was for a bridge of 760 ft. span between the points of suspension. In order to obtain a height of 215 ft. above high water mark, which was the least that the levels permitted, towers 70 ft. in height were to be built on the cliffs to carry the chains. The total length of chain, including the land-ties, was about 620 ft. Brunel himself did not approve of this plan, and only suggested it as being rather more economical in construction than his other plans. A second design for a bridge of 1,180 ft. span between the points of suspension was also not recommended by him in the report that accompanied his designs. The two other plans are more interesting. The site chosen was one where rocks rose almost vertically for a considerable height above the proposed level of the

bridge, and the chains therefore were to be hung directly from the rock, piers and land-ties being rendered unnecessary.

In his report to the committee Brunel dismissed as unnecessary the idea of breaking the span into two or three lengths, and calculated that the cost of building a pier from the water's edge to a sufficient height above the bridge to carry the chains would be at least £10,000. He thus recommended confidently the adoption of spans far exceeding in length any that had previously been constructed. He also suggested many improvements in the suspension chains.

Telford's Adverse Decision

Twenty-two plans were submitted to the committee, and of these only those of Brunel and four other competitors were selected for consideration. Brunel's friends were confident of his success, but Telford, the designer of the famous suspension bridge across the Menai Straits, who had been asked to advise the committee, pronounced against Brunel's plan.

Telford thought that the maximum span admissible was that used in his Menai Bridge, that is under 600ft., and he was emphatically of opinion that Brunel's proposed bridge would collapse in a high wind. Upon hearing of this decision Brunel asked and obtained permission to withdraw his plans from the competition, and Telford then reported to the committee that none of the remaining designs was suitable.

The only course that then remained for the committee was to request Telford himself to prepare a design, and this he did. His plan consisted of a suspension bridge of three spans, the chains being supported at the intermediate points by tall stone piers rising from the banks of the river. This design was received at first with great enthusiasm, but the more closely the committee examined it the less they liked it, and finally they determined to announce a second competition.

Brunel succeeds in Second Contest

On this occasion there was a new referee and Telford appeared as a competitor. The site of the bridge previously selected

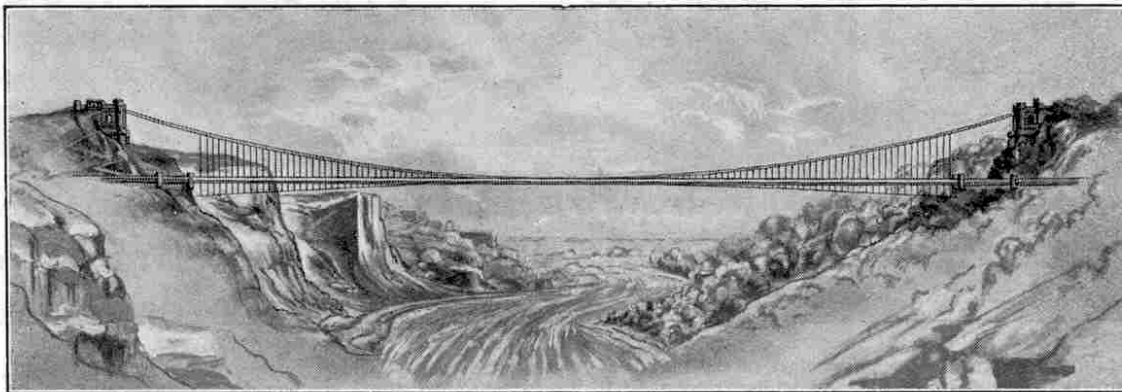

Brunel's drawing of the proposed Clifton Suspension Bridge, submitted in the first competition (1829) and rejected

by Telford was fixed, but the committee left it to the competitors to decide whether there should be one unbroken span or intermediate piers. Thirteen designs were sent in, five of which, including those submitted by Telford and Brunel, were reserved for further examination. Telford's design was put aside "on account of the inadequacy of the funds requisite for meeting the cost of such high and massive piers as were essential to the plan which that distinguished individual had proposed."

Brunel's design was placed second, but subsequently the referee changed his

Delay through Lack of Funds

The bridge works were not commenced until 1836 on account of lack of funds, but finally the first stone of the abutment

on the Leigh Woods or Somerset side of the river was laid by the Marquis of Northampton, President of the British Association, which was then holding its annual meetings in Bristol. Brunel intended in the construction of the bridge to have followed out the ideas embodied in his report of 1829, and would have preferred to have only one chain on each side of the bridge, such chains being of much greater strength than those usually adopted. In deference to public opinion, however, he put two chains, although he doubted very strongly whether they would expand equally. He endeavoured to lessen the effect of unequal expansion by arranging a stirrup at the top of each suspending rod so as to maintain an equal hold on both chains at all times, and so cause each chain to bear its proportion of the load.

In order to reduce the action of the wind on the bridge Brunel brought down the main chains in the centre nearly to the level of the platform and intended to apply the system of brace chains at a small angle to check vibration. There were also to be

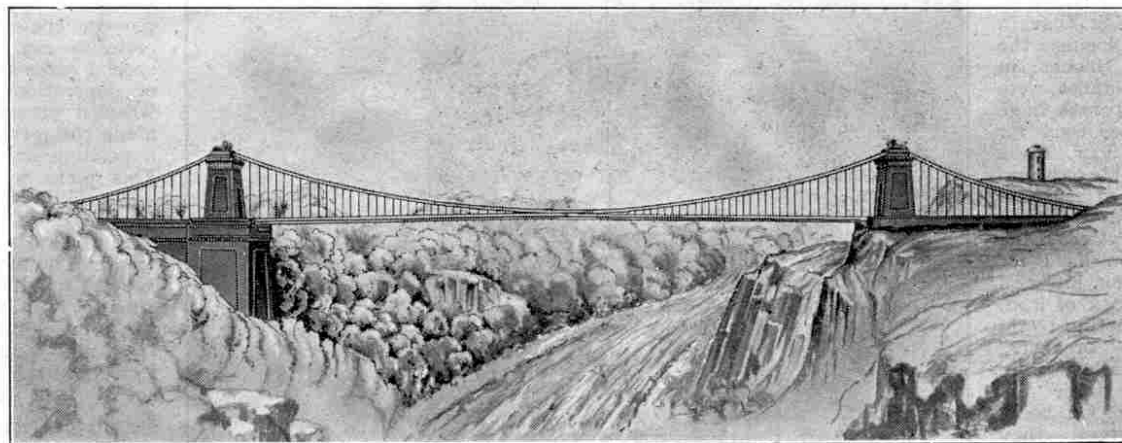

Elevation of Clifton Suspension Bridge, on which the construction of the Bridge was commenced in 1836

views. He obtained an interview with Telford, and certain explanations he then received induced him to place Brunel's design first as being superior to any of the others in regard to strength. The committee immediately accepted their referee's advice, adopted this plan and appointed Brunel their engineer.

two curved chains lying horizontally, and attached beneath the platform, so as to resist the lateral action of the wind. He introduced movable saddles to carry the chains on the top of the towers, with rollers running on perfectly horizontal roller beds. By this arrangement no pressure except a vertical one could come on the towers. He also devised means, by levers and hydraulic presses, for relieving the rollers and roller beds from pressure in the event of their requiring renewal.

Brunel's Architectural Scheme

Brunel intended his bridge to be a handsome and imposing structure and he decided to adopt the Egyptian style of

I. K. Brunel's Signature

(Continued on page 191)

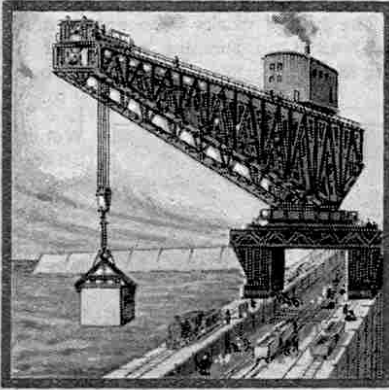

Giant Block-Setting Cranes

Their Work in Constructing
Harbours and Breakwaters

IN our last instalment we gave some particulars of the building of the Admiralty Harbour at Dover, and whilst a good deal more might be said about this very interesting work, the space at our disposal limits us. We must dismiss the subject by saying that in the Dover Harbour we have an excellent example of how, for the time being, man has won a victory over the sea. The great breakwaters have withstood sixteen winters of furious storms, and the huge waves have not damaged them in any way. The additional harbour thus reclaimed from the sea, as it were, was of incalculable value to the Allies during the War, not only as a port from which troops and munitions might be embarked to France, but also as a base for the Dover Patrol. Here, too, warships, torpedo boats and other craft that were concerned in protecting the Cross-Channel traffic from attack by enemy warships, found refuge.

The Uses of Goliath Cranes

Before leaving the subject of Goliath cranes, which were specially used in the building of Dover Harbour, we must mention that in addition to placing the huge concrete blocks in position these cranes were employed to operate huge clam-shell grabs, used for clearing the sea-floor. These grabs were capable of bringing up 5 tons of material at a time.

In many places the ground was too hard for the grabs to get a bite and then a solid block of iron, with three projecting teeth, was used. These "breakers" as they are called, were also operated from the Goliath cranes. On being lowered at speed they crashed to the sea-floor, splintering the chalk into large pieces that were gathered by the grab.

The Goliaths were also employed to lower the diving-bells from which the divers set the blocks, telephoning to the crane-man the exact direction so that he could move the crane exactly as required and so set the block in the desired position.

Mighty Titan Cranes

Another and larger type of crane used in connection with harbour construction work is that known as the "Titan," for the

construction of which Messrs. Stothert & Pitt Ltd., of Bath, are famous throughout the world.

The Titan crane has a jib of the cantilever type and the load trolley runs along its upper boom, the whole jib turning on a live ring in a similar manner to that of the large jib cranes. Usually the Titan crane is steam operated although cranes have been made for use with electric power where current is available.

Titan cranes are frequently constructed of such a size that they weigh 500 tons or more and they have been built to operate loads up to 60 tons. Recently the writer saw under construction, at Messrs. Stothert & Pitt's works, a huge Titan made for the Union of South Africa for Harbour Construction at Table Bay, capable of handling a 50-ton load, and we hope at a later date to be able to give full particulars and to illustrate this remarkable crane, which will make a splendid subject for a Meccano model.

The Titan type of crane was evolved when the block-system of breakwater construction came into general use. As in the case when Goliath cranes are employed, the massive concrete blocks are cast in special yards near the scene of operations, and are wheeled on special trucks along the pier or gantry to a position near the crane. This picks up the blocks and swings them out into the position in which they are to be fixed in the breakwater. The blocks are then keyed together, as has already been explained in these pages, in order that they may present a solid front to the devastating action of the waves.

Details of Titan's Mechanism

The Titan crane has the advantage of being mobile, so that it is possible to move it along the pier as the construction of a breakwater proceeds. Even more important is the fact that it is also practicable to withdraw it shore-wards for shelter in bad weather.

These cranes are capable of handling concrete blocks up to 60 tons in weight over a radius of 100 ft. or more. They do this by means of the long cantilever arm that is mounted on a turntable, which itself rests on a massive under-carriage. The under-carriage is mounted

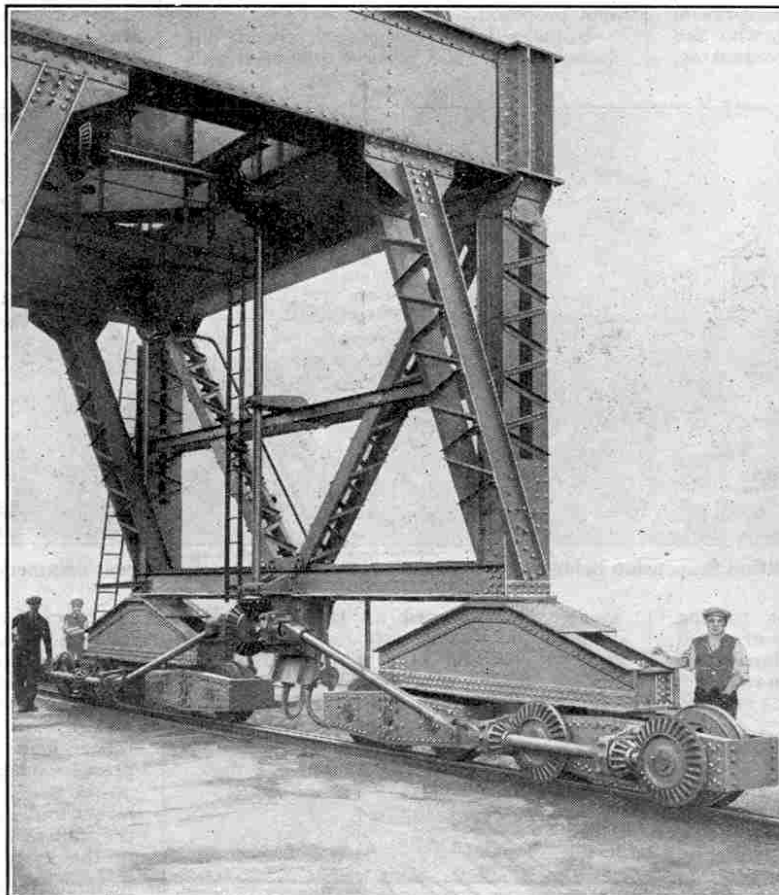
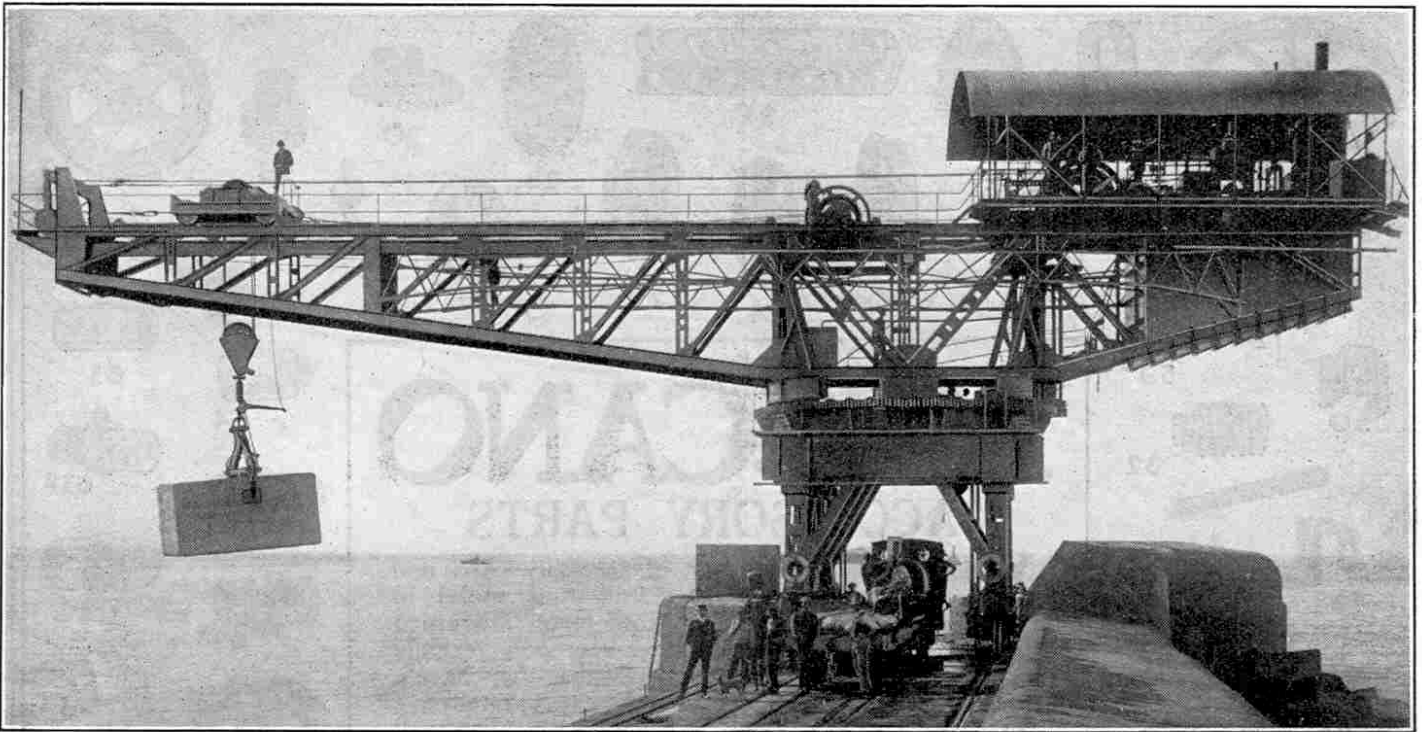

Photo courtesy]

[Messrs. Stothert & Pitt Ltd.

Our illustration shows the travelling motion of a Titan Crane. The details will be useful to model-builders, and the further information in the accompanying article will also assist them.



Photograph courtesy of]

[Messrs. Stothert & Pitt Ltd.

This giant Titan crane was built for the Union of South Africa and was erected at Port Elizabeth, South Africa, for work on the breakwater. The crane is described in the accompanying article.

on flanged wheels, running on a special track and driven by means of crown wheels fixed on the inside of the bogie. A bevel gear, which meshes with the crown wheel, transmits motive power from the main engine mounted on the cantilever arm.

The details of this power transmission are clearly shown in the accompanying illustration. Those of our readers who contemplate building a model of one of these Titan cranes will be interested to notice that the motion may be perfectly reproduced in Meccano. Practically identical parts to those illustrated are provided, including the two universal joints shown between the bevel wheel, which meshes with the vertical drive from the steam engine, and the driving rod, which is at an angle and brings the power to the crown wheels mounted on the inner side of the bogie.

The Eight-Wheel Mounting

It will be noticed that in the case of the crane illustrated the drive is taken to two pairs of wheels, one of which is the foremost pair and the other the rear pair. The drive from the same rod is transmitted to each of the two crown wheels in a very simple manner by means of small bevel wheels. The other pairs of wheels, the innermost on each bogie, are loose wheels and not connected with the driving mechanism in any way. An exactly similar arrangement is carried out on the other side of the track, the front and rear pairs of wheels being driven, and the two inner pairs being loose.

The practice of driving four wheels out of eight on each side of the track is simply one of convenience and depends largely upon the weight of the crane. In the lighter cranes it is not necessary to have four wheels to each bogie. Probably the Meccano model-builder will find that two pairs of wheels, one of each pair of which is driven, will be sufficient for the purpose,

although it is to be admitted that two bogies giving eight wheels a side do considerably assist in giving a good appearance to the model.

Massive Roller Bearings

The cantilever arm and superstructure of all Titan cranes revolves on a ring of live rollers, which in the case of a large crane may have a path of between 30 and 40 ft. in diameter. The bearings are formed by a series of turned steel rollers held in position by a suitable frame and revolving on machined pathways between the upper and lower circular girders. The tops of the rollers can just be seen in the accompanying illustration, above the segment of the large toothed wheel, and immediately below the lower framework of the cantilever arm where it rests upon the massive metal mounting.

The whole of this revolving structure is centred by means of a large central pivot, consisting of a steel rod of considerable diameter. The revolving motion is transmitted from the engine, or—in the case of an electrically-equipped crane—from the electric motor, which occupies a corresponding position on the opposite end of the cantilever arm to that from which the load is operated.

A Counterpoise Necessary

Incidentally, it may be remarked that the weight of the engine or electric motor, as the case may be, helps to balance the load, but its weight alone is not sufficient and so a massive weight has also to be introduced to act as a counterpoise. In our illustration this weight is clearly shown immediately beneath the engine housing.

Model-builders will probably find that the weight of the Meccano Electric Motor will be a sufficient counterpoise for any reasonable load, but if they contemplate building a specially large model, that will be called upon to tackle heavier loads than usual, they will find that the Meccano

4-volt Accumulator makes an excellent additional counterpoise, and that it may be easily built into place without looking unsightly. Failing this, a useful counterpoise can be made by incorporating an ordinary flat iron in the design. Very often it can be arranged so that it is almost inconspicuous, especially if the sides of the cantilever arm are closed with strips or short pieces of braced girders.

Crab Requires 4-inch Steel Ropes

The motion from the engine is transmitted through a chain of spur- and bevel-gears, which finally engage in the segmental spur track, formed around the exterior of the roller path. In some cranes the gears are thoroughly protected from the weather by covering them with heavy metal casings, but this is not always found necessary.

As previously explained, the same engine drives the travelling motion of the crane in a similar manner by rod and gearing. The gears are engaged or disengaged by the engine-man, who, of course, also controls the hoisting and lowering of the load and the movements of the trolley. This trolley—which is sometimes called the "crab" and is also known as a "Jenny"—is drawn along the cantilever arm by steel ropes and a lifting rope 4" in circumference passes over it to the hoisting block. The lowering arrangements in the crane illustrated are controlled by a patent system and hydraulic brakes, which enable the heaviest weights to be lowered within limits of a fraction of an inch with absolute precision.

Titan cranes have been built by Messrs. Stothert & Pitt Ltd., Bath, for and used in the construction of some of the best known harbours in the world including Colombo, Madras, Gibraltar, Fishguard, Peterhead, Seaham, Tynemouth, Table Bay, Gisborne, Vera Cruz, Antofagasta, Port Elizabeth, East London, etc.

(Continued on page 167)

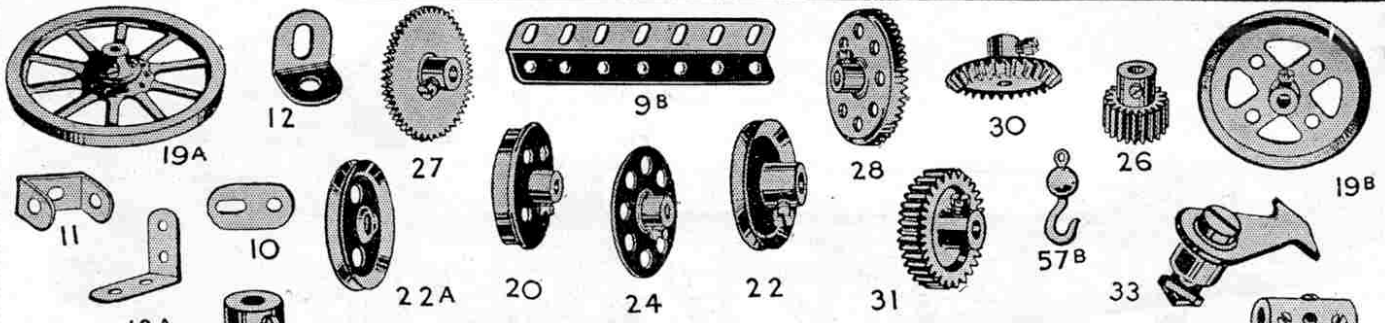

MECCANO

ACCESSORY PARTS

WE illustrate a selection of accessory parts that every Meccano boy will find useful in building the larger and more interesting models. Many of these parts have been only recently introduced, and although we know that they have a universal use (were it otherwise they would not have been added to the system) we may not yet know all their applications. There are endless possibilities in the employment of Meccano parts; indeed, we wonder if there is now a mechanical movement known to engineering that any boy cannot duplicate with Meccano.

		s.	d.		s.	d.			
10.	Flat Brackets ...	doz.	0	2	94.	Sprocket Chain per length	0	6	
11.	Double Brackets ...	each	0	1	96.	Sprocket Wheels, 1" ...	each	0	3
12A.	Angle Brackets, 1" x 1" ...	"	0	1	101.	Heads, for Looms ...	doz.	0	9
19A.	Wheels, 3", with set screw ...	"	0	8	108.	Architraves ...	each	0	2
20.	Flanged Wheels ...	"	0	6	109.	Face Plates, 2 1/2" diam. ...	"	0	4
	Pulley Wheels:				113.	Girder Frames ...	"	0	2
19B.	3" dia., with set screw	each	0	8	114.	Hinges ...	per pair	0	4
22.	1" " "	"	0	4	115.	Threaded Pins ...	each	0	2
22A.	1" " without set screw	"	0	2	116.	Fork Pieces ...	"	0	3
24.	Bush Wheels ...	"	0	6	118.	Hub Discs (5 1/2" diam.) ...	"	1	3
25.	2 1/2" Pinion Wheels ...	"	0	6	119.	Channel Segments (8 to circle, 1 1/2" diam.)	"	0	4
26.	1 1/2" " "	"	0	4	120.	Buffers ...	"	0	2
27.	Gear Wheels, 50 teeth ...	"	0	9	120A.	Spring Buffers ...	per pair	0	8
27A.	" " 57 " "	"	0	9	123.	Cone Pulleys ...	each	1	3
28.	1 1/2" Contrate Wheels ...	"	0	9	124.	Revsd. Angle Brackets, 1" ...	doz.	0	10
29.	2 1/2" " "	"	0	6	125.	Revsd. Angle Brackets, 1 1/2" ...	"	0	3
30.	Bevel Gears ...	"	0	10	126.	Trunnions ...	each	0	3
31.	1" Gear Wheels, 38 teeth	"	1	0	126A.	Flat Trunnions ...	"	0	2
32.	Worm Wheels ...	"	0	6	127.	Simple Bell Cranks ...	"	0	3
33.	Pawls (complete) ...	"	0	4	128.	Boss Bell Cranks ...	"	0	4
43.	Springs ...	"	0	2	129.	Rack Segments, 3" diam. ...	"	0	6
44.	Cranked Bent Strips ...	"	0	1	130.	Triple Throw Eccentrics ...	"	1	3
45.	Double Bent Strips ...	"	0	1	131.	Dredger Buckets ...	"	0	2
50.	Eye Pieces ...	"	0	2	132.	Flywheels, 2 1/2" diam. ...	"	2	3
57B.	Hooks (loaded) ...	"	0	5	133.	Corner Brackets ...	"	0	3
59.	Collars and Set Screws	"	0	2	136.	Handrail Supports ...	"	0	3
62.	Cranks ...	"	0	3	137.	Wheel Flanges ...	"	0	4
63.	Couplings ...	"	0	6	138.	Ship's Funnels ...	"	0	4
63A.	Octagonal Couplings ...	"	0	8	139.	Flanged Brackets, Right ...	"	0	2
63B.	Strip Couplings ...	each	0	8	139A.	" Left ...	"	0	2
63C.	Threaded Couplings ...	"	0	0	140.	Universal Couplings ...	"	0	9
64.	Threaded Bosses ...	"	0	2	144.	Dog Clutch ...	"	0	8

You may obtain Meccano Parts from your Dealer

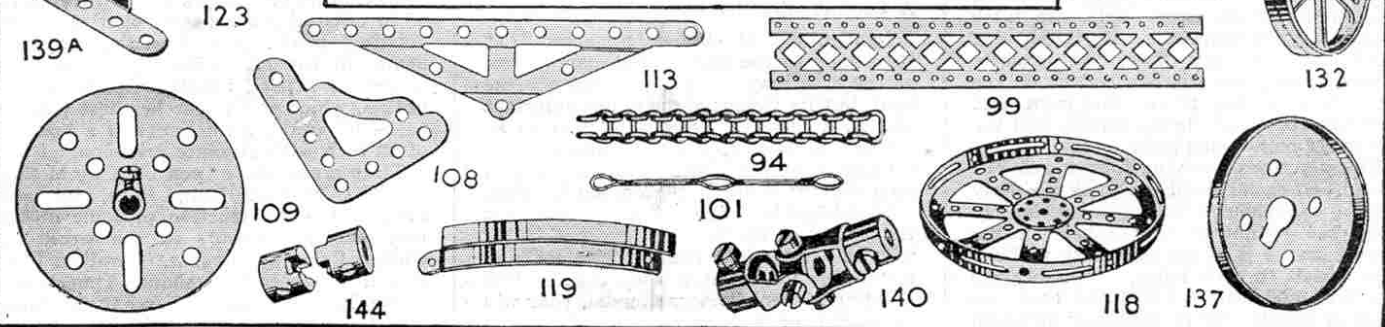
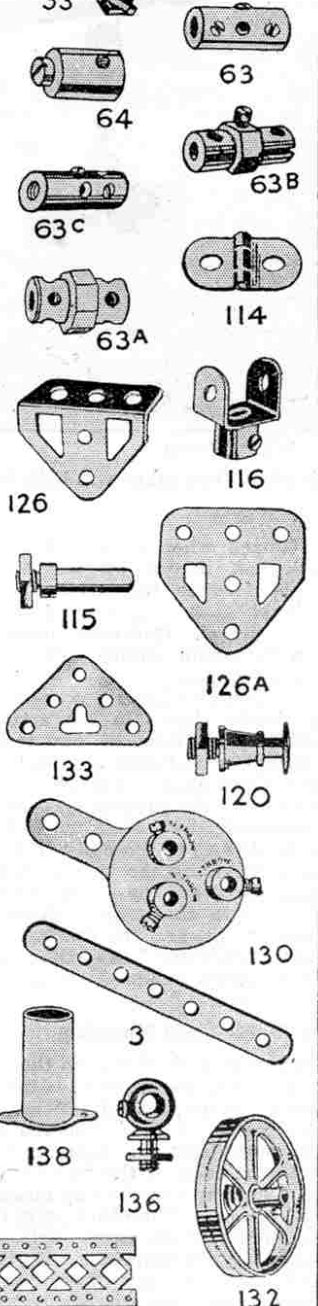

A NEW MECCANO MODEL

Model No. 618. Bagatelle Table

THIS is an excellent model that will provide amusement for many evenings. What happens is that a marble is placed in front of the cue, and the handle turned. A spring is released, the striker hits the marble a vigorous blow with his cue, and the marble shoots to the top of the table. Here it may drop into one of the holes, in which case the score is credited to the player operating the handle. Meantime the player continues to turn the handle and the marble is automatically returned to the table in position for the striker to hit it again with his cue. Should the marble drop down one of the "Stop" holes, the player loses his place, which is taken by another participant in the game.

Constructing the Model

The construction of the model is made clear by the accompanying figures, and the following detailed description will make the operating mechanism quite clear.

The operating handle (1 Fig. C) drives a $\frac{1}{2}$ " Pinion (2) engaging a $1\frac{1}{2}$ " Gear Wheel (3). This engages another $1\frac{1}{2}$ " Gear Wheel (4) on the Axle Rod of which is a 1" Sprocket Wheel (5) coupled by a chain to a 2" Sprocket Wheel (6) on the Axle Rod (7). On the further end of rod (7) is another 2" Sprocket Wheel (8) connected by Chain (9) to a third 2" Sprocket Wheel (10) on the rear Axle Rod (11).

The pusher-rod (12), by means of which the marble is driven from the point "a" (Fig. C), is carried from a $5\frac{1}{2}$ " vertical Rod (13) which is connected to an 8" Rod (14). At the front end of the latter is a 2" Rod (15) arranged vertically, and a Spring (16) tends to pull the pusher-rod forward to strike the marble. The pusher-rod is depressed against the spring by the action of two 1" Rods (17), upon which are mounted $\frac{1}{2}$ " Pulley Wheels (17a) carried from two Couplings secured on two 2" Rods (18) which enter the central Coupling (19). The Axle Rod (7)

passes completely through the Coupling (19).

The Operating Mechanism

As the Rods (17) rotate, the Pulleys (17a)

bear against the Rod (15) and depress the pusher-rod rearwardly until released, when the spring pulls the pusher-rod sharply forward to drive the marble from the point "a" along the table (20) towards the holes (21, Fig. D). When the marble falls into any one of the holes (21) it drops on to the Plate (22, Figs. A and B) formed of two $5\frac{1}{2}$ " Flanged Plates bolted together. The Plate (22) is inclined one hole down, and guides consisting of $5\frac{1}{2}$ " Curved Strips (23, Fig. B) connected to the plate by Double Angle Brackets, lead the marble (24 Fig. C) to the end of the plate, where it is retained by a $1\frac{1}{2}$ " Flat Girder (25 Fig. A) carried on a $3\frac{1}{2}$ " Strip (26) pivotally connected at (27 Fig. C) by locked nuts to a $12\frac{1}{2}$ " Strip pivoted at (29) and weighted at (30) with $2\frac{1}{2}$ " Strips.

The Strip (26 Fig. A) is guided in an Eye Piece (31), and an Angle Bracket (32) is bolted near the top of the Strip. The pocket (33) consists of three $1\frac{1}{2}$ " x $\frac{1}{2}$ " Double Angle Strips at the end of an arm (34) formed by two $5\frac{1}{2}$ " Angle Girders. The pocket is carried from the arm (34) by a 1" Triangular Plate (34a), the two base holes of which are bolted in the end holes of the Angle Girders. The pocket is bolted to the apex hole of the Triangular Plate, with three washers beneath the pocket to set it up.

The Strip (26 Fig. A) is guided in an Eye Piece (31), and an Angle Bracket (32) is bolted near the top of the Strip. The pocket (33) consists of three $1\frac{1}{2}$ " x $\frac{1}{2}$ " Double Angle Strips at the end of an arm (34) formed by two $5\frac{1}{2}$ " Angle Girders. The pocket is carried from the arm (34) by a 1" Triangular Plate (34a), the two base holes of which are bolted in the end holes of the Angle Girders. The pocket is bolted to the apex hole of the Triangular Plate, with three washers beneath the pocket to set it up.

The Automatic Return

The arm (34) is rocked from the Rod (11 Fig. C) by a Crank (35) and a Threaded Pin (36), on which engages the end hole of a $5\frac{1}{2}$ " and 3" Strip (37) overlapped three holes. The other end of the Strip is connected to a Boss Bell Crank (38) bolted to the arm (34) and secured to the Rod (39).

As the Axle Rod (11) rotates, the arm (34) is permitted to fall, and in so doing makes contact with the Angle

Bracket (32) and depresses the Stop Plate (25), permitting the marble to drop from the plate (22) into the pocket (33). Further rotary movement of the rod (11) again raises the arm (34)

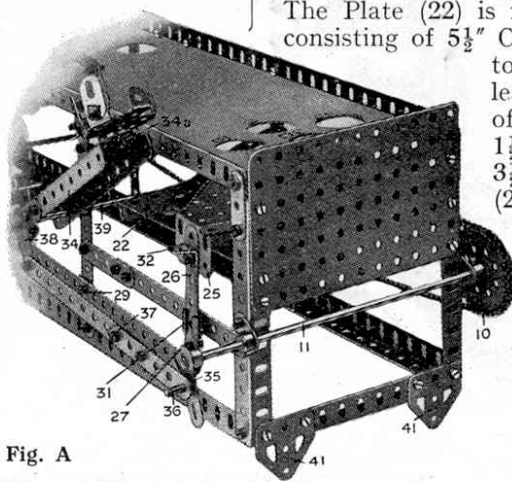

Fig. A

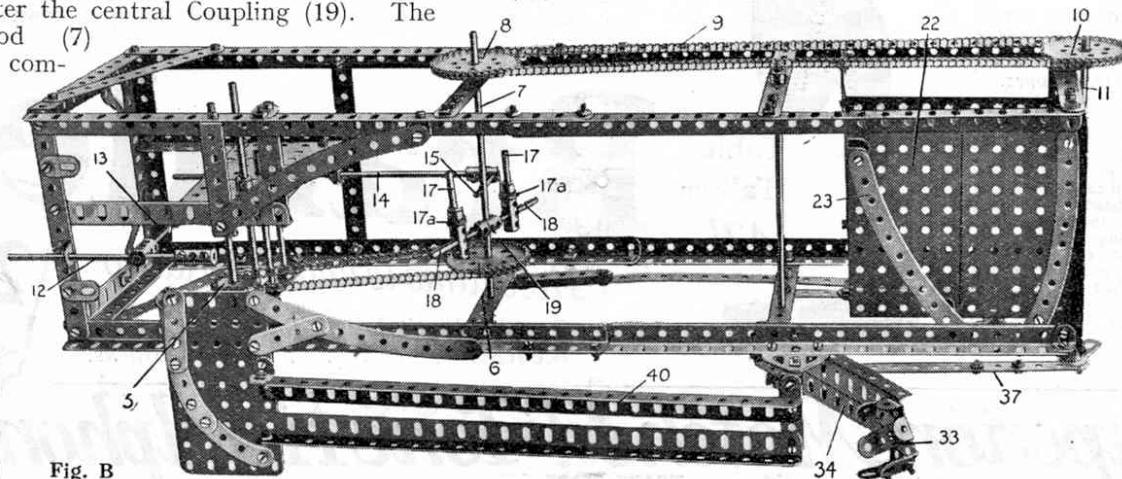

Fig. B



*Brandes Superior
"Matched Tone"
Headphones*

PRICE

20'-

*British Manufacture
(B.B.C. stamped).*

All Brandes products carry our official money-back guarantee, enabling you to return them within 10 days if dissatisfied. This really means a free trial.

Brandes Superior *Matched Tone* Headphones are admirably versatile. It's hard to imagine them fitting snugly to the tenderest curly head and yet fulfilling their duty on the head of the expert who sits down to long hours of serious experiment. So comfortable and with a rugged strength of construction to protect their delicate adjustment, they are excellent for family use. Primarily designed for long-range telephony from expert technical knowledge, their *Matched Tone* feature brings in the most distant signals with purity and strength. The experimenter finds that they bring the best results in trans-Atlantic and trans-Continental reception. One gentleman writes from Walton-on-Thames: "I received Australia on Brandes, and consider they are the most sensitive 'phones I have used. I am much pleased with their general performance." *Ask your Dealer for Brandes.*

The *Table-Talker* is another Brandes quality product at moderate price. Its full round tones are wonderfully clear and pleasing. The horn is matched to the unit so that the air resistance produced will exactly balance the mechanical power of the diaphragm. This means beautiful sound balance. Gracefully simple of line, it is finished a shade of neutral brown and is twenty-one inches high.

... every one of these advertisements will show an added advantage in the construction of Brandes Headphones.

Look at the illustration above. See how snugly the 'phones fit the head. A gentle pressure on the crown, a firm clasp to the ears, and the rest of the headband is held well away from the hair. This means long-wearing comfort and the shutting out of extraneous sounds. Strength and firm beauty of line typifies their finished construction.

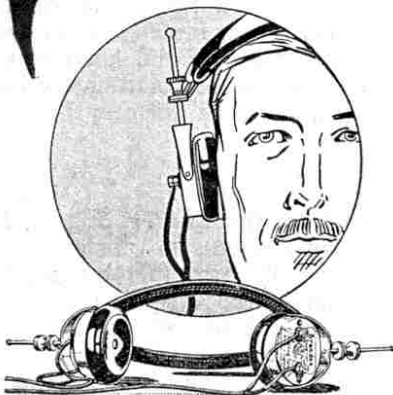

Table-Talker
42'-

Brandes

The Name to know in Radio

Brandes Limited, 296, Regent Street, W.1
WORKS : : : : Slough, Bucks.



Superior "Matched Tone" Headphones

TRADE MARK

with the marble in the pocket, until the marble is deposited into the chute (40) and is returned to the point "a" (Fig. C).

Meanwhile, on the rising of the arm (34) the weighted strip (28) again raises the Plate (25) closing the outlet from the inclined Plate (22). The bearings for the Axle Rod (11) are formed by two 1" Triangular

rod end by forming at the other end two feet with two Flat Trunnions (41) bolted to the lower 5½" Angle Girders.

Origin of Bagatelle

This model affords yet another striking example of the versatility of Meccano. Every boy knows 40 that in addition to hundreds of

As in the case of many of our games—such as billiards, chess, and draughts—the origin of the Bagatelle game is unknown, but in all probability it is extremely ancient.

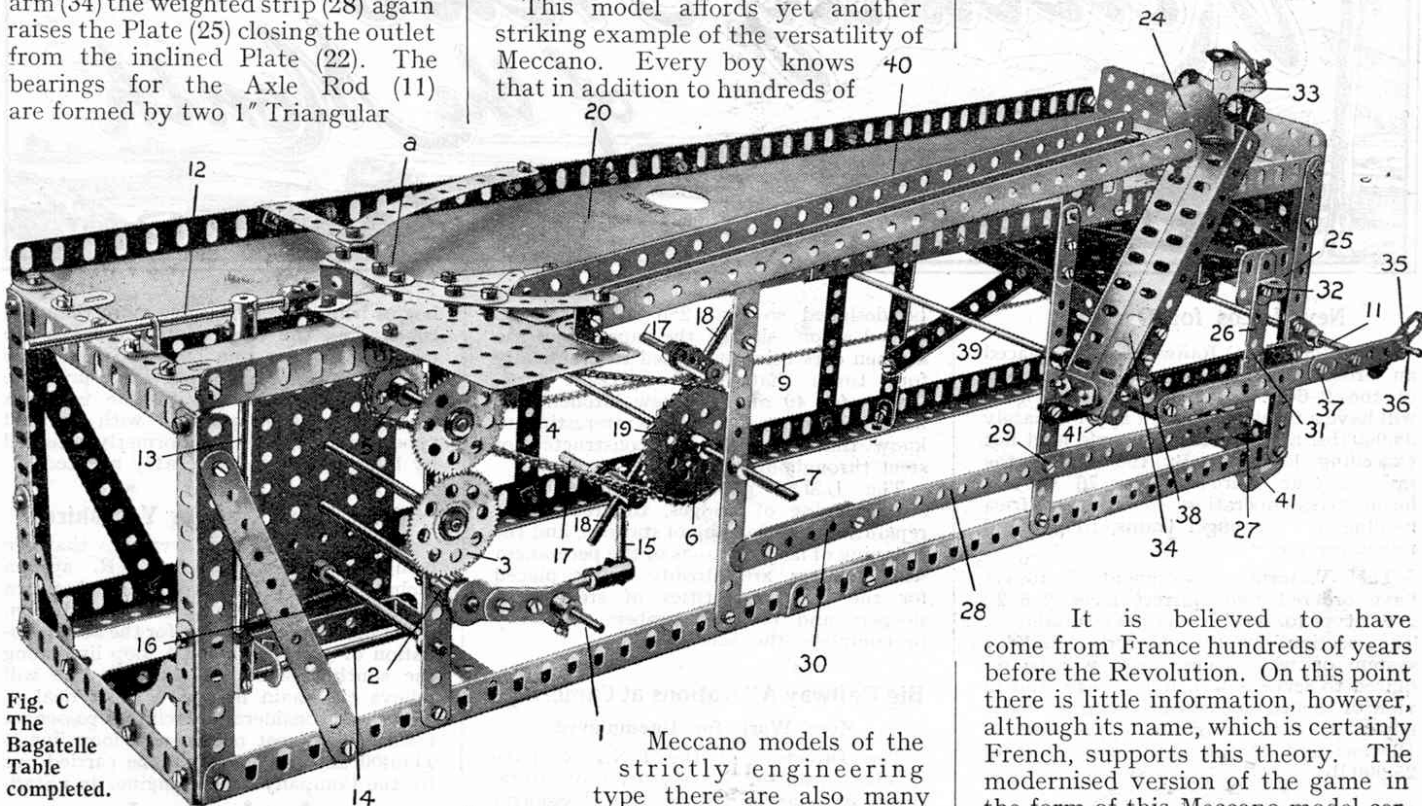

Fig. C
The Bagatelle Table completed.

Plates secured to the rear vertical Angle Girders.

Figure D shows the shape and size of the cardboard table. The holes (21) should be made only slightly larger than the marble used, which, by the way, is not included in the Meccano Outfits. The table is given a slight incline towards the pusher-

Meccano models of the strictly engineering type there are also many of an amusing and humorous type. A glance through the complete Manual brings to light such models as Drop the Nigger, St. George and Dragon, the Meccano Family, Box Ball Alley, Silhouettograph, the Wrestlers, Galloping Donkey, etc. Such models as these provide many hours of fun and, indeed, some may be called pastimes in themselves. In this class of model pride of place must be given to the Bagatelle Table.

It is believed to have come from France hundreds of years before the Revolution. On this point there is little information, however, although its name, which is certainly French, supports this theory. The modernised version of the game in the form of this Meccano model certainly gives endless fun, whatever its origin!

The mechanical side of the apparatus is very ingenious in that the ball, whilst in play, is not touched by hand unless it falls in one of the "stop" holes.

NEXT MONTH:—
PLATFORM SCALES

Parts required:

1 of No.	1	6 of No.	38
10 "	2	1 "	43
2 "	2A	1 "	46
1 "	3	3 "	48
1 "	4	2 "	48A
6 "	5	1 "	50
4 "	6	2 "	52
6 "	6A	1 "	52A
10 "	8	1 "	53A
11 "	9	9 "	59
6 "	10	3 "	62
5 "	11	7 "	63
9 "	12	1 "	70
1 "	12B	3 "	77
4 "	13A	4 "	89
2 "	14	2 "	90
1 "	15	3 "	95
2 "	15A	1 "	96
1 "	16	1 "	103H
3 "	17	2 "	108
2 "	18A	1 "	111A
1 "	18B	1 "	115
1 "	26	1 "	125
2 "	27A	3 "	126A
134 "	37	1 "	128

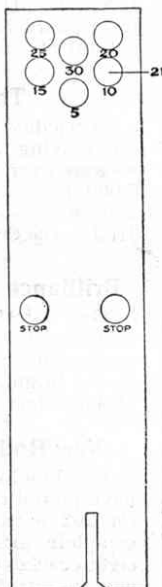

Fig. D

Giant Block-Setting Cranes—(Continued from page 163)

The Titan illustrated at the top of this page is a splendid example of this type of crane. Erected at Port Elizabeth, South Africa, it has played an important part in the construction of the harbour-works and breakwater.

Details of the Titan Illustrated

The total weight of the crane is 261 tons. The overall length of the cantilever arm is 119 ft., the height of the top portion of the cantilever arm from the ground being 40 ft. The length of the arm from the centre to the nose—that is the end at which the load is operated—is 78 ft. 9 in., so that the tail—or the portion of the arm on which the engine-house is situated—is 40 ft. 6 in. in length from the centre of the arm. The crane arm revolves on a roller path, which has a diameter of 24 ft., and the arm is capable of being slewed through one complete revolution in three minutes.

This crane is capable of lifting a maximum load of 40 tons and the arm can move this load over an area the maximum radius of which is 65 ft. The total height of lift of the load is 30 ft., and the load may be lowered 58 ft. below the level of the track. The crane is thus capable of lifting a load over a total height of 88 ft.

A two-cylinder steam engine is used, the diameter of the cylinders being 11 in. and the stroke 18 in.

The crab runs on four wheels and a lifting rope of 3½ in. circumference is used. The crab has a slow speed of 22 ft. per minute and a quick speed of 45 ft. per minute. Its hoisting speed on slow gear when lifting its maximum load is 8½ ft. per minute. Its speed when racking on low gear with maximum load is 22 ft. per minute.

The crane runs on 16 wheels, each of which is borne on springs. The width of the track from centre to centre of the rails is 17 ft.



New Locos for Overseas

The Rhodesian Railways have placed an order for four Garrett Locomotives of the 2-6-2:2-6-2 type. These locos will have a tractive effort of approximately 35,000 lbs. and a maximum axle load not exceeding 13 tons. By the end of the present year there will be 76 Garrett locomotives operating in South Africa hauling fast passenger trains, freight and mixed service.

The Victoria Government Railways have ordered two Garrett locos 2-6-2:2-6-2 type for service over heavy gradients. The section of the Victoria Railway system on which these locos will be required to serve is 2 ft. 6 in. gauge, and in view of this the locos will be exceptionally powerful, each weighing approximately 18 tons and having a tractive effort of 25,000 lbs.

Articulated Passenger Trains

The L.N.E.R. have decided to build all their new passenger trains on the articulated principle. This principle, which has already been described in the "M.M.," is based on the fact that the ends of two coach bodies are made to rest on one bogie. Some months ago the L.N.E.R. ordered 29 complete trains and suburban coaches on the articulated principle. These are being built by the principal carriage-building firms in this country. Each train will consist of 10 coaches in two units of five, and a complete train will seat 872 passengers.

L.M.S. Developments

It is announced the L.M.S. are to spend £14,000,000 on extensive schemes in renewals, extension and maintenance. Only part of the work will be done by the Company's own workmen, the remainder being carried out by outside firms. The work includes the construction of entirely new trains; new sleeping cars; and new rolling stock for mineral and live-stock traffic. Some 30,000 new wagons are to be built, including a number of refrigerator cars and special wagons for the transport of motor vehicles and for handling grain in bulk.

Over 235 new locomotives are to be built, including 220 large passenger and freight locos, and nearly £5,000,000 will be spent on the building of 2,600 passenger coaches, the majority of which will be of the corridor type. New restaurant cars, embodying the latest developments, will

be designed so that 250 meals can be served at one sitting, the capacity of the kitchen cars being increased to practically four times that of the present type. Orders for 40 of these new kitchen cars have been placed and it is interesting to know that they will be constructed of steel throughout.

The L.M.S. plans also include the strengthening of bridges, the rebuilding, repainting and cleaning of stations, and the re-laying of large sections of the permanent way. Orders are already being placed for the large quantities of steel rails, sleepers and crossing timbers necessary to complete the scheme.

Big Railway Alterations at Cambridge

More Work for Unemployed

The Directors of the L.N.E.R. have sanctioned an extensive scheme of alterations at Cambridge. The Passenger Station platform is to be considerably lengthened, and the old Newmarket line, which has been used for the storage of carriages, is to be handed over to the Corporation for a new arterial roadway. This will greatly assist the development of the University town and provide work for unemployed for some time ahead. The new scheme also provides for the concentration of signalling work, the provision of new up and down goods yards, and the entire re-arrangement of the railroads at this centre.

Famous Loco for America

The Stephenson engine, which has occupied a site on the island platform at Newcastle Central Station for many years has been taken to pieces. It is going first to Darlington and then to America for exhibition during the railway centenary. Workmen began to dismantle the old engine last month.

More Comfortable Travel on the L.N.E.R.

Further to our note last month regarding articulated trains we are now able to announce that the L.N.E.R. have decided to construct all new trains—including main line Sleeping Cars, Restaurant Cars, and Suburban trains—on the "articulated" principle. The L.N.E. Railway is the first British railway to adopt this new method of construction, which means a great advance in comfortable travel. As most of our readers know, in the articulated system buffers between carriages are dispensed with, the wheels and

bogies being made to serve more than one coach, i.e., the ends of two coaches are made to rest on one bogie. In addition to exceptional comfort this principle enables more carriages to line up at a platform than is possible with the old type carriages, the space formerly occupied by buffers being considerably reduced.

New Loop Line for Yorkshire

Alterations and improvements that are being made on the L.N.E.R. system include an additional route line between Barnsley Junction and Penistone Station, a distance of about a mile, for the accommodation of goods traffic. A loop line along the south side of the existing line will relieve the main line of a great deal of traffic and considerably facilitate passenger traffic. The cost of the new loop line is £11,000 and the work will be carried out by the Company's own Engineering Staff.

Sale of Government Locomotives

The L.N.E.R. have just completed the purchase from the Government of 48 locomotives of the 2-8-0 type. These engines will be used for heavy mineral traffic after being reconditioned at the Company's Gorton shops.

Travelled a Million Miles

Mr. John Goy, of Bourne, South Lincs., has retired after 41 years' service on the L.N.E.R. During 34 years as a passenger train guard he travelled 135,000 journeys, a total of 1,077,544 miles.

The Day's Work

Every day on the L.N.E.R. 7,000 engines are moving 21,000 coaches and 300,000 wagons over 7,000 miles of track. Over 5,000 horses help the delivery of goods, and 40 vessels ply from Harwich and Hull to the Continent and on the Clyde.

Brilliance of New Signal Lamps

The latest automatic signal lamps that have been installed on the Marylebone section of the L.N.E.R. are visible even in the brightest sunlight up to a distance of 4,000 feet.

New Rolling Stock for L.N.E.R.

The London & North Eastern Railway have placed orders amounting to £540,000 for 202 passenger carriages including six complete articulated suburban trains of eight coaches each. All these new carriages will be fitted with electric lighting and steam heating.

Keeping Goods Dry in Winter

BY OUR SPECIAL CORRESPONDENT.

During one of the very heavy showers of rain that have been so frequent this winter, I was standing at a station of a big main line railway when a long goods train of 50 wagons rattled through. The wind was blowing the rain in all directions, and as I watched this heavy train on its journey I began wondering how the goods, so carefully packed in warehouse and factory, were kept dry, and whether the heavy tarpaulin covers really succeeded in keeping out the wet.

A few days later I was able, through the courtesy of the officials of the L.N.E.R., to visit one of their many factories devoted to the production of wagon sheets and covers. For the sake of convenience these hives of industry are situated in various parts of the L.N.E.R. system from King's Cross to Aberdeen, but the methods employed in turning out and repairing the thousands of tarpaulins used on the L.N.E.R. are the same in each case. The story of how these damp-resisters are made to meet all demands is full of interest.

I found that out of the hundreds of thousands of tons of goods, a large proportion of which is foodstuff, carried each year, a very small part gets damaged in transit owing to bad weather. This is only when the tarpaulin covers are temporarily removed in loading and unloading the wagons.

I noticed gangs of expert workmen handling the finest quality of canvas of approved thickness, 36" wide. This is sliced into lengths which are sewn together on huge sewing machines specially constructed and which carry two needles instead of one. Ring holes are cut, strengthening pieces added and the tarpaulin in embryo is sent to the waterproofing plant. Huge rollers grip the cloth and a swinging brush forces linseed oil and vegetable black into the heart of the material. Drying follows, when the proofing process is repeated. Six times in all the sturdy canvas goes through the mill, when it assumes a leathery texture that will keep out frost and damp.

A workman artist then stencils the magic initials "L.N.E.R." on its surface. It is given a nice long number and the cryptic signs 1/25—1/26 are stamped

on the corners with red lead paint. This ensures ready knowledge of the age of the cover without reference to the long number, and the second sign is an indication to the staff that it is due back for re-proofing in the first month of 1926.

Six years is the average life of these damp-resisters, each of which weighs something like 1 cwt. when new. If they were heavier one porter would not

Rails a Hundred Years Ago

When we are comfortably seated in the "Flying Scotsman" and moving along from King's Cross to Edinburgh at the rate of 70 or 80 miles an hour, we do not perhaps realise the contribution that the rails themselves make towards the comfort of modern travel.

In view of the Railway Centenary Celebrations this year a few particulars about the evolution of rails may be of interest to readers of the "M.M."

Wooden rails were used for horse-drawn traffic 250 years ago, but iron rails came into general use when George Stephenson laid the Stockton and Darlington Railway. This was the first Passenger Railway in the world, and was opened for traffic in September 1825. The rails were 15 ft. in length and had upper flanges 2½ ins. in width and weighed about 25 lbs. per yard. A heavier pattern was used in 1829 for the Liverpool and Manchester Railway, the upper flange being 2½ ins. in width whilst the rails were 2½ ins. in depth at the ends, and 3½ ins. in the centre. Double-headed wrought iron rails were used

Steel Grain Wagons for South Africa

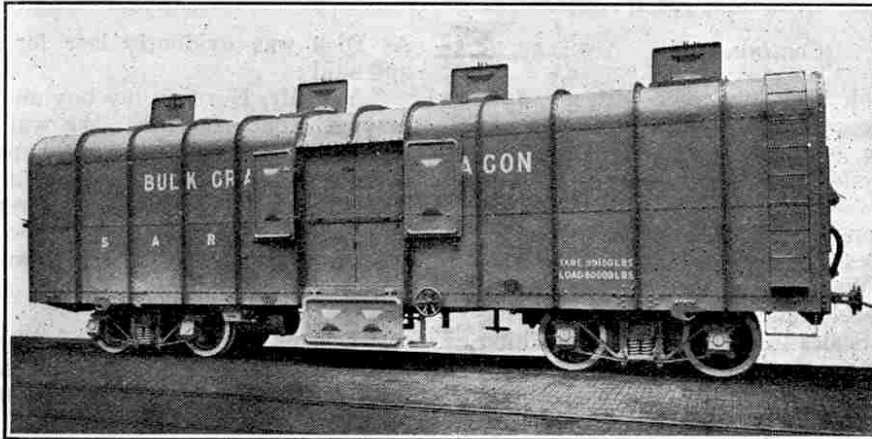

Photo courtesy]

[Messrs. Leeds Forge Co. Ltd.

Our photograph shows an all-steel 40-ton Bogie Wagon built by the Leeds Forge Company Ltd., for use on the South African Railways. Of these wagons, 350 have been ordered for use in conveying grain in bulk from the farming districts to South African ports. The wagons are specially designed to suit the elevator system now being installed at the main up-country stations, and at the ports of Cape Town and Durban.

The wagons are built for the 3 ft. 6 in. gauge, and arranged for end- or bottom-discharge. They are constructed with pressed steel underframes and body parts, and the principal dimensions are:—

Length over buffers	39 ft. 11½ in.	Height over all	12 ft. 0½ in.
Length over body	36 ft. 11½ in.	Width over all	8 ft. 10 in.
Centres of bogies	24 ft.	Diameter of wheels	2 ft. 10 in.
Bogie wheelbase	5 ft. 9 in.	Size of journals	10 ft. by 5 in.
Load	80,000 lbs.	Tare weight	39,150 lbs.

be able to handle them and here lies the test of the sheet-maker—lightness with durability.

Little ropes are tied through the ring holes and the new sheet is ready to cover soap, candles, groceries, flour, provisions, pianos, or any other of the thousand-and-one items of interest carried in railway wagons. The sheets that cover the nation's food must always be kept up to A1 standard.

A regular examination goes on daily and defective sheets are at once sent to the repair factory where, by ingeniously hauling up the whole to cover a sort of proscenium, two experts in the darkness caused by the sheets soon spot and mark with chalk all the tiny holes and slits that may let moisture through. Gangs of men then seize the defective tarpaulins and literally sit on the holes—darning the little ones and patching the larger tears. Once through the proofing plant and the job is complete.

I didn't see any tar in the tarpaulins, but I certainly came away impressed with the care taken of my "bacon and eggs" by the goods department of the L.N.E.R.

in 1842, 15 ft. in length and weighing 68 lbs. per yard, and secured in chairs by wooden keys much in the same way as at present. An interesting reference to these keys is made in the Rule Book of the Stockton and Hartlepool Railway, 1841, which tells us that "every plater to pay a fine of 2/6 for each key along his length which should be found out, and a like amount to be paid by every engine-driver for stopping at any beer house on the line."

In 1835 Joseph Locke introduced a type of double-headed rail, but on account of its inherent defects the present bull-headed type was gradually evolved, and its acknowledged superiority soon resulted in universal adoption.

In 1875 a bull-headed rail, 24 ft. in length and weighing 83 lbs. per yard, was introduced and this was followed in 1896 by rails weighing just over 100 lbs. The modern rails which carry the "Flying Scotsman" and which are used on the main lines of the L.N.E.R. at the present time are all of finest steel, 45 and 60 ft. in length, 2½ ins. in width on the top flange and weigh 95 lbs. per yard.



Dick's visit to MECCANOLAND

Where dwell the Happy Boys

(Continued)

NEXT morning I took Dick into town with me, and, calling at the Meccano offices, asked if we could see Mr. Hornby. The attendant conducted us into the Meccano model-room, and asked us to wait there.

What a sight! Dozens of different Meccano models were displayed on tables arranged around the room—Towers and Bridges; Wagons and Cranes; an electrically-operated Big Wheel, taller than Dick; Moving Stairways; Platform Scales; Drilling and Punching Machines; Machine Guns; and a Motor Chassis that seemed to be a perfect miniature of the real thing. The Cranes were of every imaginable type, from huge Ship-yard Gantries to the small Portable Cranes you see on railway platforms. All the models were the finest little pieces of mechanism I had ever seen, and they worked in a most realistic manner. The Cranes hoisted real loads, the Scales weighed, the drills of the Drilling Machines turned, and so on.

I noticed Dick standing spellbound in front of a Meccano Clock, watching the pendulum tick off the seconds in business-like style.

"Look! Dad," he exclaimed, "it's a real clock and it keeps time. I wish I could build one like that. I wonder if I could?"

"We'll have a try at it together when we get home!" I assured him, "and perhaps Alan will come over to give us a hand."

Just then the door opened, and an alert, well-built man of about middle age entered. He took no notice of me but crossed over to Dick. I could tell by the kindly smile of approval at the boy's look of wonder and fascination that here, sure enough, was a friend of all the boys who crossed his path. I felt at once that this must be Mr. Hornby, the inventor of the world-famous toy.

"You wanted to see me, didn't you?" he asked Dick.

As Dick was evidently lost for words, I came over and said:

"Yes, Mr. Hornby, my boy and I are under the spell of your wonderful toy. We want all the information we can obtain about it, first hand, if we are not trespassing too much upon your time."

"Not a bit," was the genial reply. "Nothing gives me greater enjoyment than to spend an hour with boys, talking to them about model-building."

"Tell us about Meccano!"

"Tell us about Meccano!" ventured Dick, whose courage was rapidly coming back. "How long did it take you to invent it, and did anybody help you, and did you . . ."

I tried to restrain my excited boy, but Mr. Hornby laughed in the kindest sort of way and said: "That's all right, youngster; it was 'wanting to know' that caused Stephenson, Edison, Marconi and many others to become great and famous men. 'Wanting to know' and 'finding out' are qualities I like to see in any boy, and"—looking at me approvingly—"Dick has both, I see. Come along into my office, where we shall not be disturbed, and I will tell you some interesting things about Meccano."

We followed him into his cosy well-furnished office, where he quickly made us very much at home.

A Live Paper for Live Boys

"I won't go into the history of Meccano," he said, reflectively; "for that is a very long story and it would take me a long time to tell. It has already been printed in our Magazine, and thousands of our readers have asked that it may be told again in that paper, so, perhaps, some day we shall re-print the story. By the way, I must tell you about the *Meccano Magazine*, the Meccano boys' paper, which is published on the first of each month. Its pages are brim full of just those articles that you would like, Dick.

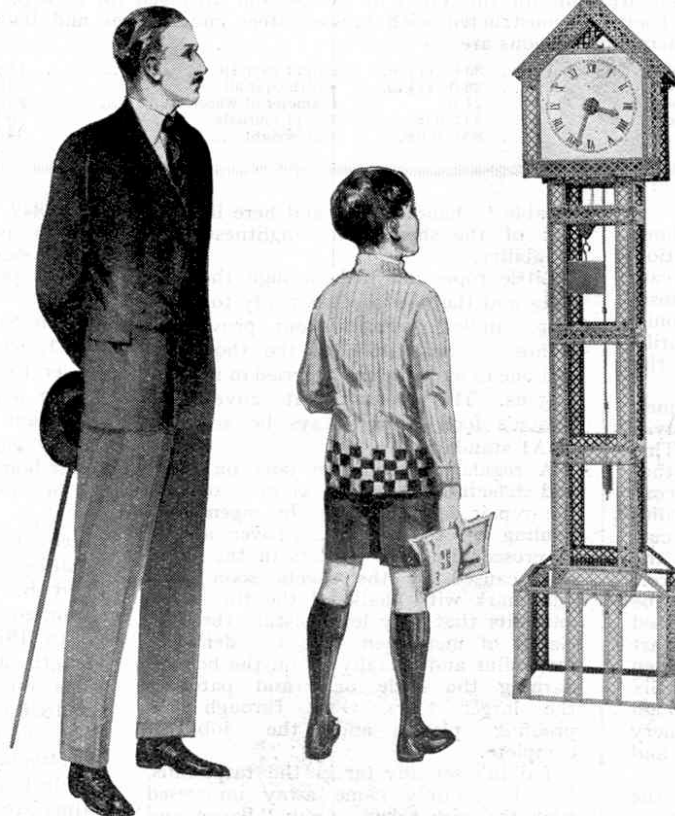

Dick . . . in front of the Meccano Clock, watching the pendulum tick-off the seconds . . .

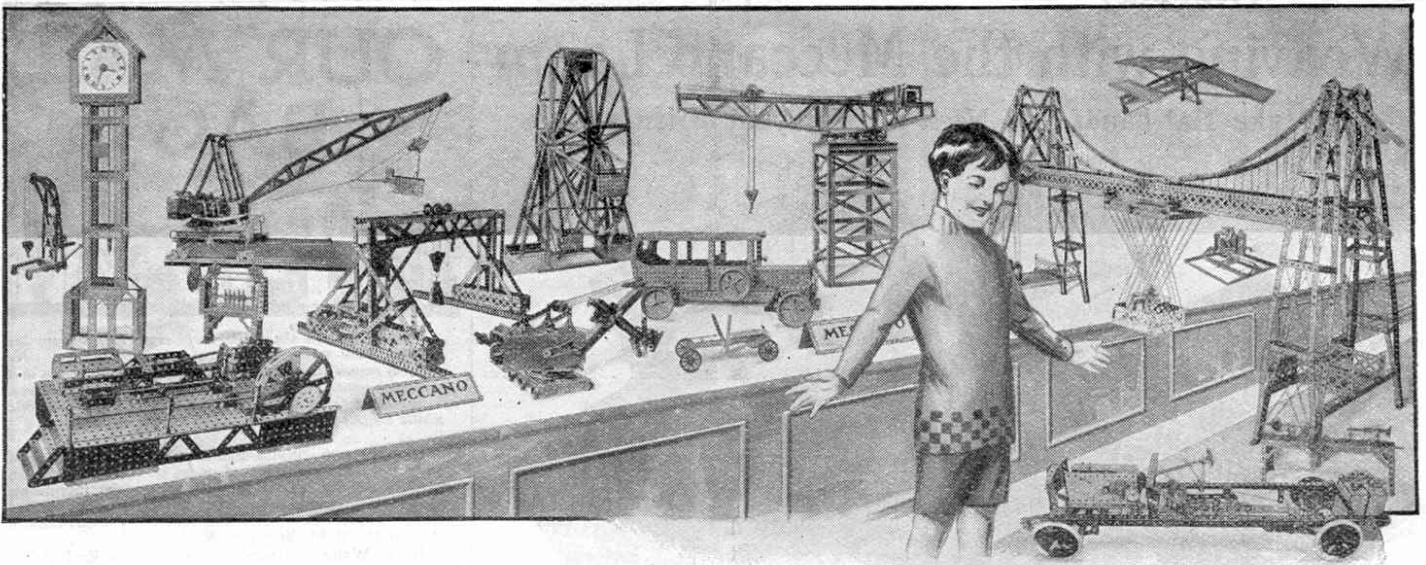

Dick in the Model Room

For instance, in this month's issue there is an article on the life of a famous engineer, an article on Electricity, a description of a Giant Crane, with pages of Inventions, Radio and Stamps. In fact everything in which boys are interested is dealt with in our Magazine. Our great aim is to see that every boy gets full value out of his Meccano Outfit. Here we describe fine new Meccano Models, and give helps and hints on model-building generally."

"How topping," Dick exclaimed, "but where can I get the *Meccano Magazine*?"

"You may order it from any newsagent or bookseller or it will be posted to you direct from the works, if you wish," replied Mr. Hornby. "At present it goes to over 50,000 boys all over the world. It reaches every civilised country, and I strongly suspect," he continued, looking at me with a merry twinkle in his eye, "that there are as many fathers who read it as there are Meccano boys!"

A Meccano Prize Winner

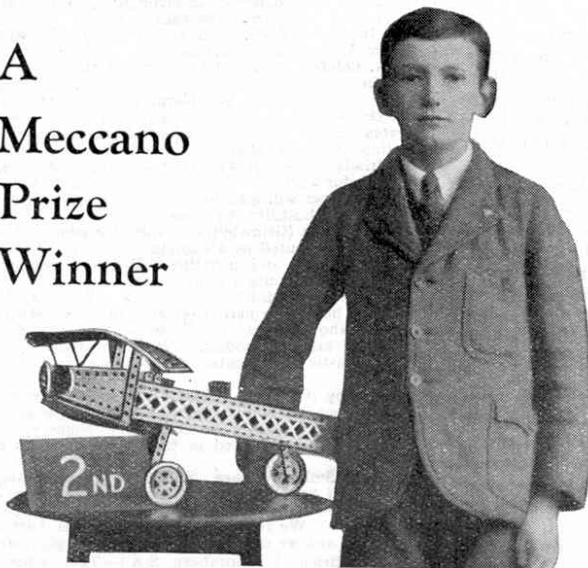

Our illustration shows W. Malcolm, of Edinburgh, and his Meccano model of an Aeroplane with which he won the Second Prize (Silver Medal) in the Amateur Class at the Edinburgh Industrial Exhibition.

Every Boy Loves Engineering

"Meccano," continued Mr. Hornby, "has now taken its place in every country in the world as the great constructional hobby for boys. Nearly every boy has a natural inclination towards the mechanical. That is the reason why railway engines and clockwork and mechanical toys have always had such enormous sales. These toys, however, had serious drawbacks. They broke easily, each one was limited to a single movement, and when the boy became tired of this one movement that was the end of his fun. I think the reason why Meccano has superseded these mechanical toys is fairly obvious. The boy selects the toy he would like to play with—a crane, a wagon, or a bridge—and builds it himself with his Meccano parts. The only tool he needs is his screw-driver (even this he finds in his Outfit), and in a very short time he has before him the toy he wants, strong and unbreakable, ready to give him hours of intense enjoyment. When he grows tired of his crane, or whatever model he has built, he takes it to pieces, and with the same parts makes a bridge, a wagon, or some other model that appeals to him.

"There is no end to the fun any boy can have with Meccano, and the number and variety of models that he can build is unlimited. Why, a boy can have a new toy every day in the week all his life through if he wishes! And every boy derives just as much pleasure from putting his model together as in playing with it."

"I suppose, though," I interrupted, "before a boy begins building with Meccano he should have a little engineering knowledge; otherwise, how is he going to put together a clock or a motor-car, or any of those other marvels we saw in the model-room a little while ago?"

"Not at all," replied Mr. Hornby. "Even if a boy has never seen a machine in his life, he can build any of the hundreds of models shown in our Book of Instructions. I don't suppose that many boys start on the big models. They get loads of fun from the simpler ones, and while they are building these they are acquiring skill in putting the parts together and becoming familiar with the names and uses of all the various parts, so that when they come to the bigger models they have no trouble whatever.

(To be continued)

Weaving with the Meccano Loom

Make Hat-bands and Neck-ties for your Friends

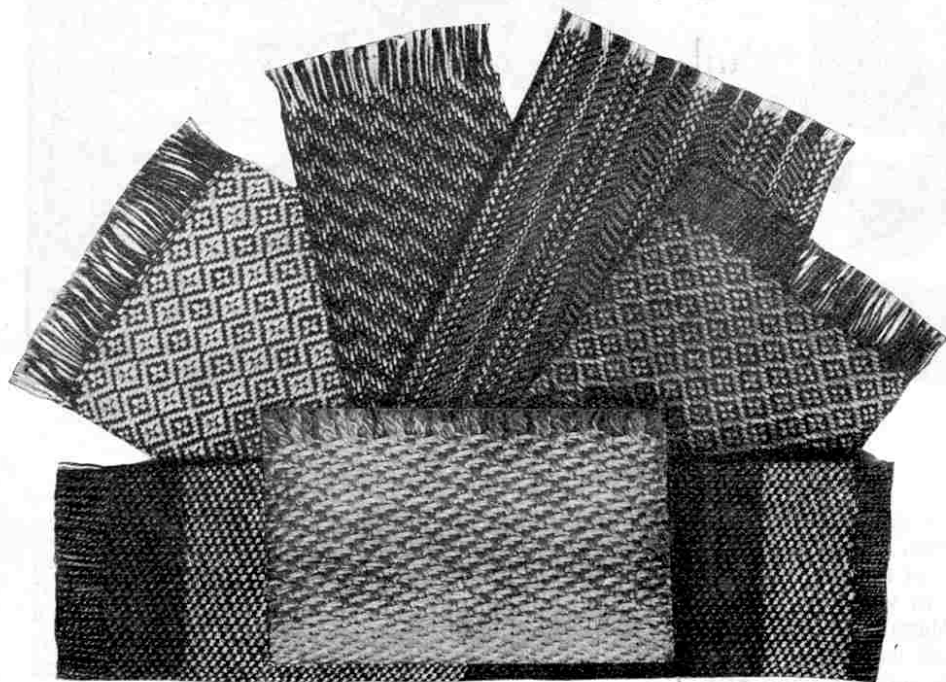

The above illustration shows some of the beautiful material that may be made with the Meccano Loom. Unfortunately, it is not possible to reproduce the finished product in colours, so that the illustration gives but a poor idea of the attractive appearance of the finished fabric, the patterns of which are worked in blue, orange, gold, red, etc.

These fabrics were woven entirely on a Meccano Loom from silks such as you buy in the hank or in bobbins. They represent only six of the infinite number of patterns obtainable, the designs of which depend entirely upon the mechanical skill and the artistic ability of the person working the Loom.

If it is desired, fabrics that are entirely plain may be woven, or a simple or intricate pattern introduced at will, in any chosen colour. The width of the material depends upon how you construct your Loom. On all Meccano Looms the fabric may be woven to any desired length, however, for when the threads of the warp are exhausted they may be joined to more threads carried on a second beam, and the process continued indefinitely. Similarly, when the weft in the shuttle has all been used, a new shuttle may be slipped into position in an instant and the weaving continued. The process need not be completed at one operation, as weaving may be stopped at any time and re-started when required, without the continuity of the material being broken.

The Story of Metals—(cont. from page 189)

very suitable for the manufacture of spoons, forks and similar articles. It soon tarnishes, however, and for that reason it is usually electro-plated. German silver has a high electrical resistance and on that account is largely used for making resistance coils.

Copper is very largely used in the world's coinage. The British bronze coinage is composed of 95 per cent. copper, four per cent. tin and one per cent. zinc.

Weaving with the Meccano Loom is delightfully simple. All that is necessary is to turn a crank handle—the model does the rest. There is a certain knack in turning the handle, however, but this is soon acquired. Perhaps the only difficulty is to get the edges of the material even, but this comes easily after a little practice.

Fabric woven with the Meccano Loom makes beautiful hat-bands or neck-ties. Tastefully woven, these make excellent gifts for your friends. Imagine their surprise when you tell them the fabric is made to your own design on a model loom of your own construction.

You cannot buy the Meccano Loom, for it is built of Meccano parts—the same Meccano parts that make the Clock, the Chassis, and hundreds of other Meccano models. It is great fun building the Loom and even greater fun weaving with it. Full instructions for building the Loom are contained in a well-illustrated leaflet on art paper, price 4d. post free from this office.

Silver and gold coins both contain copper as a hardening alloy, "standard silver" having 7.5 per cent. copper and "standard gold" 8.33 per cent. Nickel coins used in the British colonies and elsewhere contain 75 per cent. copper and 25 per cent. nickel.

NEXT MONTH:—
THE STORY OF LEAD

OUR MAIL BAG



In this column the Editor replies to letters from his readers, from whom he is always pleased to hear. He receives hundreds of letters each day, but only those that deal with matters of general interest can be dealt with here. Correspondents will help the Editor if they will write neatly in ink and on one side of the paper only.

R. J. Brown (Walthamstow).—"I hope that you will increase the number of pages in the 'M.M.' with the New Year, even though this means increasing the price. I would not miss it for anything, no matter what the price is." You will find the present issue a step in the right direction, R. J.

D. S. Waite ("Eversley," 4, Elmers End Road, Anerley, London, S.E.20).—"We are very interested in the magazine called the 'Club' which you, assisted by your friend, are publishing. We feel sure that if any of our readers are interested they will write to you.

T. Farrell (Colombo, Ceylon).—"We have written you separately regarding Electric Furnaces and the firm who manufacture them, and have also sent you a copy of our August issue, which contains information that should be of use to you. If we can help you further, let us know.

H. J. Sharood (Halifax, N.S.).—"We received a long letter from A. V. King, of H.M.S. 'Hood,' in which he told us of the kindness of yourself and your mother when he visited Halifax. We hope you may meet again.

H. C. Ferdinands (Kinala Lumpur, Malay States).—"The 'M.M.' subscription rates have been sent to you, and on hearing from you again we will post copies to your friends. We send our warmest greetings to you all.

A. R. Lyell (Karong, Hawthorn, Vic.).—"I attend Scotch College, which as everybody knows, is the finest school in the world." We didn't know it before, Andrew, but no doubt you are right. We will endeavour to find a suitable correspondent in Scotland for you.

Roy Collins (St. Leonards, Tasmania).—"Q. 'What is the difference between a sigh, a motor car, and a donkey?' A. The first is 'Oh! dear,' the second 'too dear,' and the third is 'you dear!' Did you intend that for us, Roy, or did you just wish your effort to go into the Puzzle Page?"

R. Cain (Manchester).—"On the new L.M.S. poster, showing the interior of a cotton mill, a weaver is shown putting on her clogs. She is fastening one on her foot and the other clog on the floor has the fastening on the same side as the clog already on her foot." You certainly have sharp eyes, Robert, and the fact that you have detected an error in this poster shows also that you are observant. As to the reason for the error—why, even artists are human and we all make mistakes sometimes!

A. Colefax (Newcastle).—"Sorry, Arthur, but never having been a tramp we cannot give you the information you require! We learn, however, that some of the strange signs that tramps chalk on doors and gates for the guidance of those of the fraternity who follow are:—A boot (this needs no explanation)! A triangle ("spoilt by other tramps.") A diamond ("safe for a meal at the back door.") Circle and cross ("the owner will give to deserving cases.") A square ("general hostility to tramps.")

R. Barker (Grimsby).—"Thanks for photo of your Eiffel Tower used as a Christmas tree and festooned with lanterns and novelties. It looks wonderfully well, and was quite a brainy idea."

J. B. Ash (Middlesbrough-on-Tees).—"We are always glad to hear from parents of Meccano boys, especially those who themselves take a hand in the glorious work of building models. We much appreciate your enthusiastic comments on Meccano and Hornby Trains."

B. Roy (Calcutta, India).—"We welcome you as a new-comer to Meccanoland, and we hope you will spend many happy years in the country. Your photos will be entered in the Overseas photo competition."

J. J. Smith (Grange, S. Aus.).—"Many thanks for photos of South Australia's largest locomotive. We are pleased to know that your prize arrived in perfect condition. We receive many letters from Australian readers, and we read them all with much pleasure."

L. O'Brien (Johannesburg, S.A.).—"Thanks for your news and interesting letter. We hope you will pass your Matric. safely. Your radio queries are being dealt with by the Radio Editor."

A. Hewitt (Holyrood, Ontario).—"We are glad to hear from you and to know that you have found a good job and are happy in it. Let us hear from you often."

"Nothing New Under the Sun"

An Iron House Built 100 Years Ago

OUR article* last month, describing the recently-invented method of building steel houses on the Meccano principle, dealt with what was supposed to be one of the latest inventions. The old saying that "there is nothing new under the sun" is amazingly confirmed in this case, for further investigation shows that the idea of steel houses is not nearly as modern as one might think.

Advantages of All-Metal House

In this connection it comes as something of a shock to find that at Tipton, in Staffordshire, there is an iron house that is so old that no one can be found to say how old it is! No one knows why it was made of iron, or who was the clever engineer who forestalled modern inventors. This is to be regretted, for we feel sure the name of the inventor would have merited record and his reasons for using metal, instead of stone or brick, would have provided interesting reading.

This old iron house at Tipton is the property of the Birmingham Canal Navigations Limited, and is situated at the side of No. 1 Lock, Tipton Green. It is occupied by Mr. Jones, one of the company's lock-keepers, and his wife, who declares that it is the most comfortable house she has ever lived in.

"It's as dry as a bone," Mrs. Jones told an interviewer, "cool in summer and as warm and cosy in winter as anybody could wish. What is more it is vermin-proof, for vermin never think of trying to bore their way through these iron walls!"

Why the House is Dry

The house is of the bungalow type and contains four rooms—two bed-rooms, a sitting-room and kitchen. The walls are of iron and sunk in a concrete foundation. Iron girders support a slate roof and everything else in the house is of iron, even the window frames.

The iron plates of the walls are flanged, the flanges in the interior being used to take wooden laths to support the plaster. Between the plaster walls and the iron outer walls is a cavity, which probably explains why it is that the house is so dry and comfortable.

When the house was new, ornamental iron-work extended around the eaves, but nearly all of this has

now fallen away except in one or two places. No doubt this iron work formed a target for stone-throwing youngsters for many years, in times long past, and this fact may account for its disappearance.

Was it once a Toll-House?

It is impossible for anyone to say how long it is since the iron house was erected. The records of the Birmingham Canal Navigations

Ltd. go back to about 1790, but it is not mentioned in them. Even "the oldest inhabitant" of Tipton cannot help declaring that the house has always "stood where it is now!"

There is a tradition in the district, however, that the Iron House has not always stood where it is to-day, and that it originally stood on the West Bromwich to Birmingham Road, where it served as a toll-house. Mr. Henshaw, the Manager of the Birmingham Canal Navigations Ltd., has kindly informed us that he thinks this statement is probably correct, as "a drawing—dated 1871—

shows the house in question to resemble the type of toll-house used about this period. Many of these toll-houses were done away with about 1870 and it is probable that the old drawing was made when the house was transferred from its original site to where it now stands at Tipton Green locks."

It has been suggested by someone that if the Iron House was originally a toll-house perhaps the idea in building it of iron was to permit of its being moved from place to place along the canal. It would be built at a time when the canals were being developed and a movable house would certainly be a great advantage, but—if the Canal Company really bought the Iron House when it stood on the Birmingham to West Bromwich Road, this explanation scarcely holds water. Instead it merely explains why the Canal Company bought the house, and we are no nearer to the original idea of the builder of the house.

Whatever may be the explanation, it is very interesting indeed to find this early example of the most recent development in house construction. It must be very gratifying to those who are so strongly recommending the construction of steel houses to find that an iron house, built over 100 years ago, is not only habitable to-day but is in practically as good a condition as it was when it was first erected.

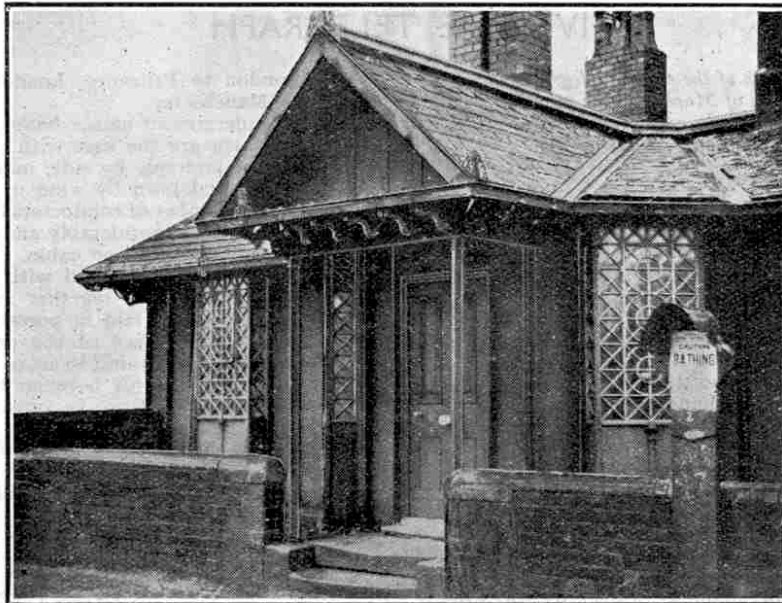

Photo courtesy]

The Old Iron House at Tipton, Staffs.

[“Birmingham Gazette”



Electricity

XIV. THE TELEGRAPH

Last month we traced the growth of the electric telegraph from its earliest days up to the time of Morse. This month we deal with the apparatus and methods employed in telegraphic communication at the present day.

* * * * *

EVERYONE is familiar with the tall telegraph pole, and its cross arms supporting white "pots," or insulators. These insulators are made of porcelain or coarse earthenware. They vary in shape, but their essential features are shown in Fig. 1, which is a sectional drawing of the Cordeaux type of insulator.

The peculiar shape of this insulator is designed to prevent line leakage in wet weather. The wire is attached around the groove G, and it is obvious that moisture would have to creep up the insides of the two overhanging roofs R, as well as to cover the outsides, before the wire would be electrically connected by a film of moisture to the iron stem S by which the insulator is attached to the cross arm of the post.

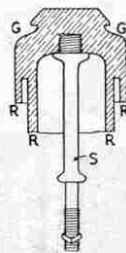

Fig. 1. Cordeaux Insulator

London to Penzance, London to Liverpool and London to Manchester.

Underground cables have many advantages, the chief of which are the ease with which a large number of lines can be laid side by side, and the fact that they are safe from breakdown by wind or snow.

The number of conductors enclosed in each underground cable varies considerably and as many as 1,200 wires may be contained in one cable. The individual copper wires are separately covered with a loose layer of paper and then loosely laid together and enclosed in a stout lead pipe, which is laid in porcelain pipes buried about 2 ft. below the surface of the ground. The purpose of the paper covering is not to act as the insulator, but to separate the wires, the air between them then acting as a most efficient insulator. In order to achieve this end it is essential that the paper is wrapped loosely about the wires and that the wires shall not be laid tightly together. The paper form of covering has been found to be very serviceable so long as the lead pipe remains in perfect condition. If the pipe becomes

Overhead Lines

Telegraph poles are generally red fir trees, creosoted to preserve the wood, and embedded from two to four feet in the ground. There are from 15 to 22 poles for every mile of line. Each pole has an inverted V-shaped roof of metal to protect its top from

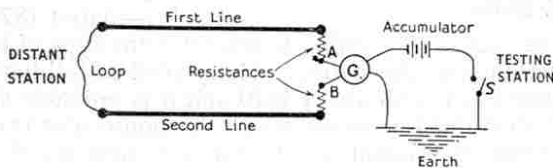

Fig. 2. How Telegraph Lines are Tested

moisture. A lightning conductor or earth wire, extending from the top to the ground, is also fitted.

Iron wire is used for telegraph lines in the majority of cases, owing to the high cost of copper wire. Five different gauges of iron wire and four of copper wire are in use, the gauge to be employed in any particular case being determined by the length and nature of the circuit.

Underground Cables

Underground cables have been much used in place of overhead lines during the past fifteen years. Many towns in this country are doing away with their existing overhead lines and laying underground cables in their place. Trunk lines also are now being laid underground in increasing numbers. The four longest underground trunk lines are those from London to Edinburgh,

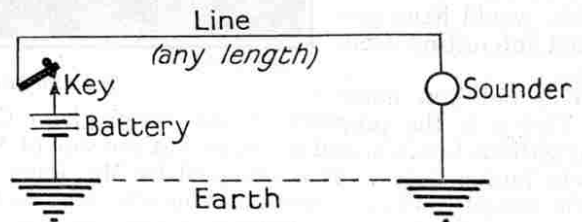

Fig. 3

punctured or cracked, however, and moisture enters, the whole of the wires inside are thrown out of order through breakdown of the insulation. When a fault of this kind has been located it is usually necessary to insert a short length of new cable.

Whilst the porcelain pipes are laid, in short lengths of about a yard, a rope is threaded through them and a gap made every 100 yards or so. The rope is attached to one end of the lead cable which is then hauled through the pipes by pulling the rope at one of the gaps.

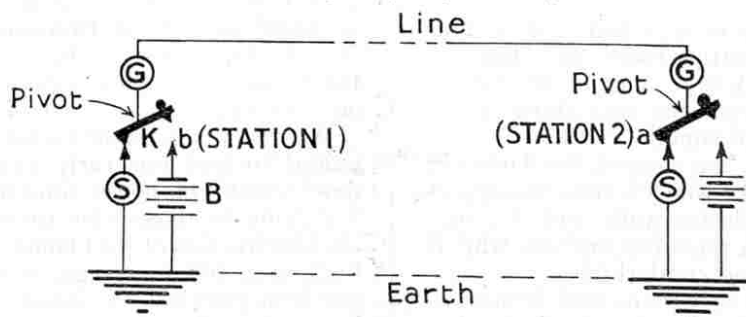

Fig. 4

How Telegraph Lines are Tested

All important telegraph lines are tested frequently to detect electrical faults. The lines are tested in pairs, the two being looped together at the distant station by a short length of wire. At the testing station resistances,