

Cut wing struts from 1/16 sht. Chamfer ends to fit sandpaper edges

BRIGADYR

by Ray Malmström

Balance point when suspended from a thread and pin pushed into this point. Model should hang level from front and side views.

Fuselage shape (in heavy outline) from 1/8 sht.

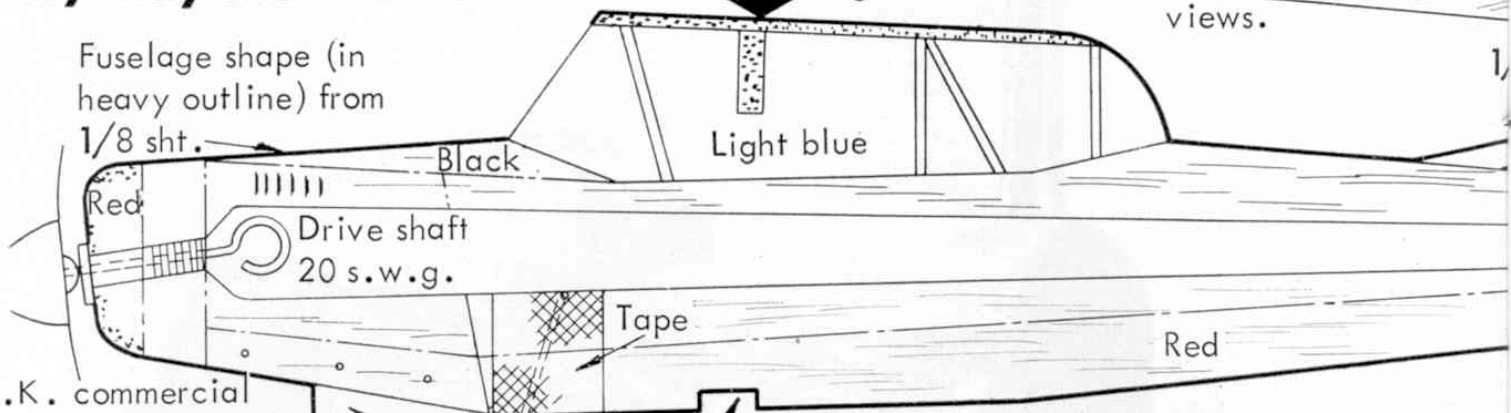

K.K. commercial 5" dia. plastic prop cut to 4.1/4" dia.

Side pieces (2) 1/8 sht.

Propeller detail

Remove tips. Sand round

Tailplane leading edge



Decoration detail

Fin 1/16 sht.

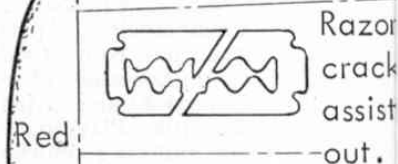

Do not dope any part of this model

Tightly fitting elec. tubing or blob of cement

Bend undercarriage wire to this shape 20 s.w.g. wire

Wheels from 1/4 sht

Power: 7.1/2" loop 1/8 strip. A 12" loop 1/8 strip can be used for longer flights. (max. turns 600)

Red Lightly score along

Cut wing from sheet

Turn wing over, put cement in crack and raise one

Greaseproof paper

wing panel 2.1/2" as shown. Pin other panel to board.

Your full-size plan

BRIGADYR

A 14 inch wing span, rubber powered, semi scale, profile model of a Czechoslovakian maid-of-all-work aircraft.

Designed by Ray Malmström

NOT VERY many full-size aeroplanes these days lend themselves to easy reproduction in model form and still fly "off-the-drawing board." The little Czechoslovakian *Brigadyr*, however, proved to be just the job for the simple-to-build profile model we present for your delight, this month. The real *Brigadyr* is indeed a maid-of-all-work being employed extensively as an agricultural aircraft, and also equipping the Czechoslovakian Air Force for observation, photography and parachute duties.

The plan and easy-build sketches of our 14 in. span *Brigadyr* supply all the information you will need to build a "full-of-fly ability" model; but before we go on to the all-important flying notes, one or two points may assist your construction. A sharp pointed knife, or a razor blade cracked in two to give a sharp point, will assist in cutting accurately the fuselage shape. See plan. Note direction of grain for nose pieces and fin. Use medium grade balsa throughout. Retain the undercarriage and rear hook wire with pieces of this tape. Cement well and rub the cement into the material and allow to dry completely. Check when assembling the wing and tailplane to the fuselage that they are true and not twisted. Decoration of the parts should be done as soon as they are cut from the sheet, and before assembly. We invented a new method of colour application on this model, which avoids heavy dopes or paints, and results in a bright, colourful finish. Possibly in your art periods at school you have used a new form of pastels that are really oil colours in stick form. These are ideal for decorating your little *Brigadyr*. Simply mask off the area to be coloured with Sello-tape (wing tips and leading edges, tailplane tips, fin leading edge, nose pieces and lower part of fuselage on this particular model). Rub on the oil-colour pastel fairly thickly with a soft rag, gently smooth out the colour to get a very pleasing solid-colour effect. It looks good and adds no weight to your model. Try this new method (applicable to all small sheet models), it really works. You can obtain a small box of oil-colours in stick form (one manufacturer calls these oil colour sticks "Cray-Pas Crayons") from your local art dealers. They are great for painting colourful pictures with too! Elevator lines are easily put in with a ruler and ball-point pen.

Plan Instructions

The full-size constructional plans on pages 260 and 281 should be removed from the magazine (joined) by undoing the binding staples, removing pages 261-'80, and then replacing them. Page 281 shows assembly in easy-to-follow sketch form.

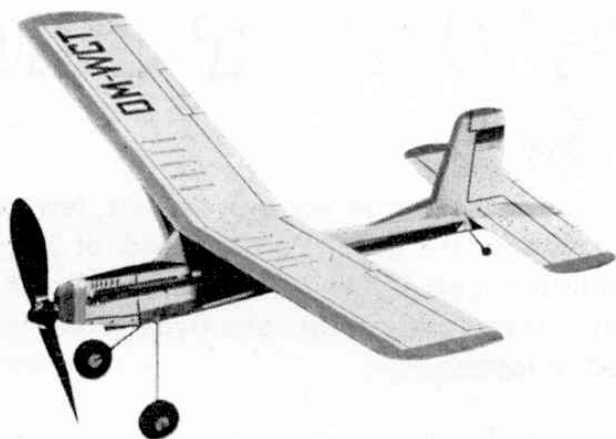

Flying notes

Install the rubber motor (one loop $7\frac{1}{2}$ in. long, $\frac{1}{8}$ in. strip rubber) after having put rubber lubricant (6d. a tube from your hobby shop) on the rubber. Balance the model carefully as indicated on the plan. You may need to add a small quantity of plasticine to the nose or tail to obtain correct balance. Choose a calm day for your first flight, and carry them out over long grass. Point the nose of your model into any breeze that may be blowing and launch it gently with nose pointing slightly downwards. Never throw the model. Your *Brigadyr* launched from shoulder height should glide straight down and land about 20 feet away. If the model climbs steeply, falls back on the tail, and then dives (stalls), add a little more weight to the nose. If it dives, remove some nose-weight or bend up the rear edges of the tailplane a very little ($\frac{1}{32}$ in. to $\frac{1}{16}$ in. will be enough). Make sure the glide is straight. If the model turns sharply to left or right, check that the wings are not warped. If they are, breath gently on them, twisting out the warp. If there are no warps and the model continues to turn sharply, bend the rear edge of the fin in the opposite direction to the turn. Once the model glides satisfactorily you can try a "power-on" flight. Wind the propeller about 150-200 turns and launch gently, releasing the propeller first. Your *Brigadyr* should climb away, turning slowly to the left. When the power runs out, it should glide in to a smooth landing. With each successful flight you can increase the turns up to a maximum of about 320. Remember to rub some lubricant on the motor after every two or three flights. Stalls, dives or excessive turning under power can be corrected in the same way as we mentioned above for gliding tests. Build and balance your *Brigadyr* according to the plans and these notes, and you will get many steady flights and happy landings from this model.

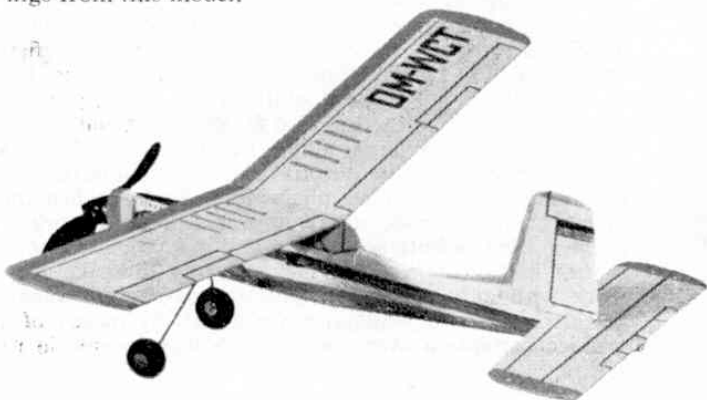

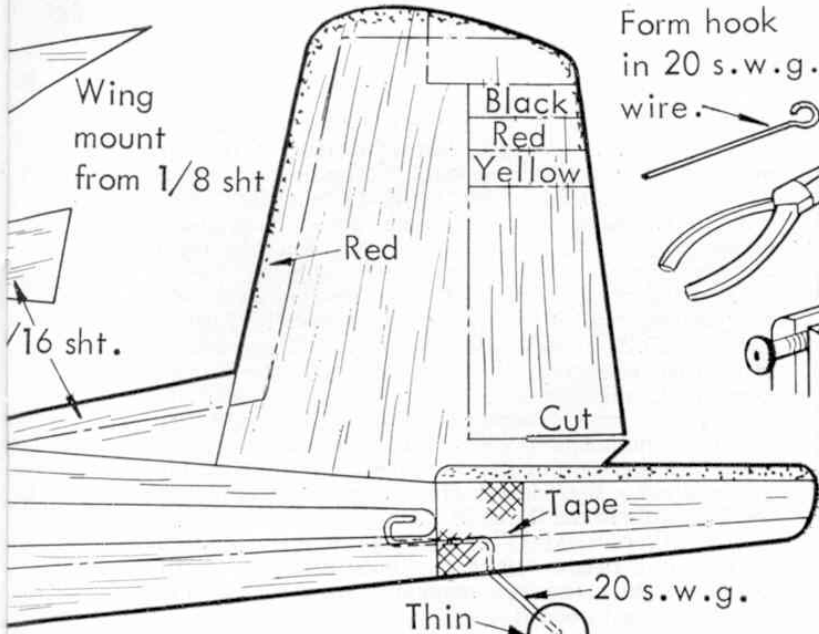

Form hook in 20 s.w.g. wire.

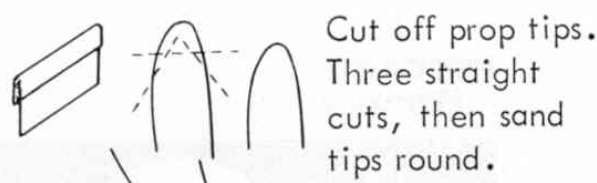

Insert wire through bush. Slip on a cup washer and prop. Finally bend wire to engage blade.

Cut brass bush to length

Assembly Stage 1

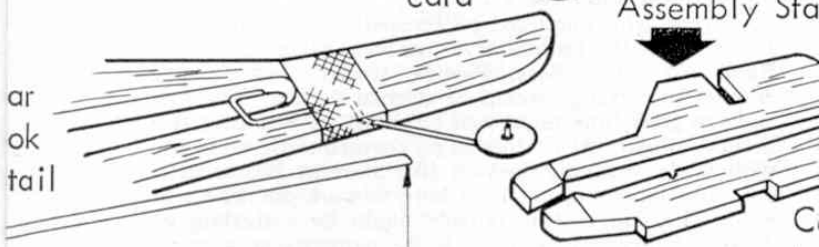

Assembly Stage 2

Cement prop bush assembly in nose slot and side pieces.

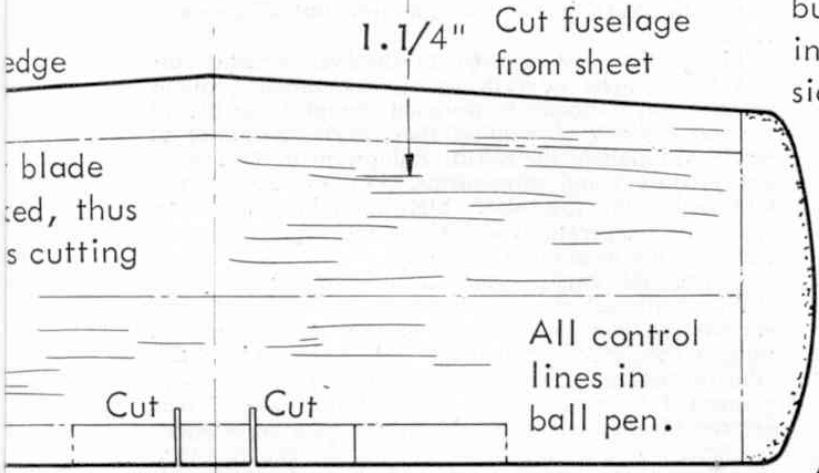

Assembly Stage 3.

'V' cut

Add tailplane and then fin. Note cuts

