

Building 'Bangthorn'

by Mike Rickett

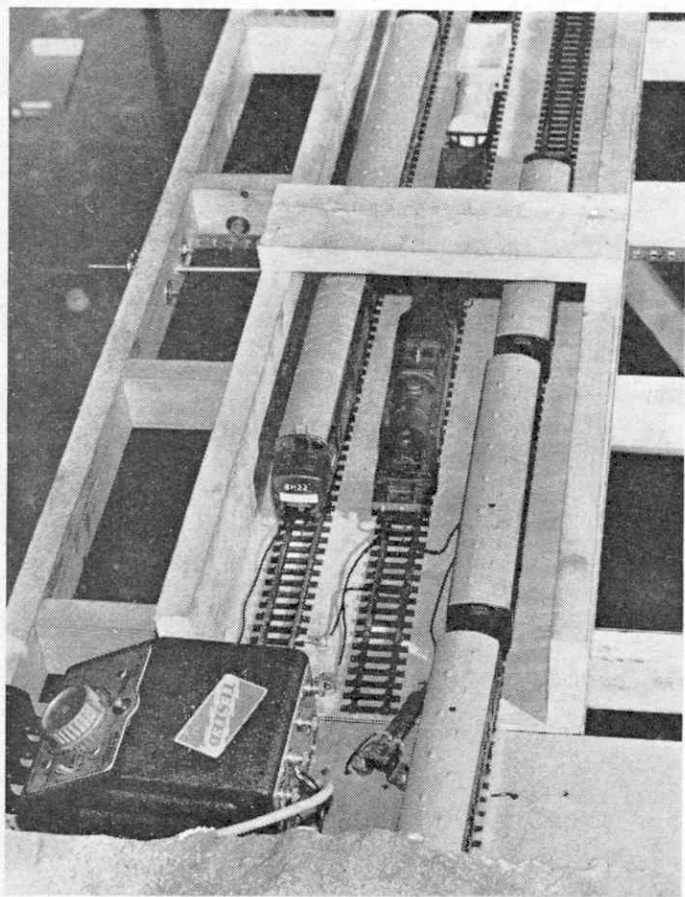

This month, we start a series of articles which will describe in detail every stage of building our branch line, from baseboard right through to scenery and operation. Every station must have a name, and after a lot of thought, and a lot of anagrams based on the words 'Tri-ang Hornby' we arrived at — Bangthorn. Although you won't find it on any map, from December 27th to January 10th, Bangthorn will be quite close to Olympia on the Circle line, as it will form a prominent part of our stand at the Schoolboys and Girls Exhibition. See you there!

THERE is indeed much to commend branch line practice to railway modellers for, because of the usual problem of space, very few of us are ever likely to have sufficient area, money, or time to build a model that would really do justice to a main line railway. The usual oval or continuous layout needs a lot of space before it becomes really satisfying for any length of time and simply running trains round and round can eventually become a little dull.

Realistic

One of the most important advantages attached to a branch line layout is that it can be made to occupy very much less space than any continuous layout, a consideration of the greatest importance in these days of smaller houses. A layout of this sort also lends itself to timetable or sequence operation, but most important, the construction of more realistic scenery becomes much easier.

Of the two types of end-to-end layout, the station to storage siding arrangement is both cheaper and less demanding of space. The plan with this article shows an example of such a layout and we shall be showing, during the next five or six months, the step by step construction of it, from baseboards to the finished scenery.

Bearing in mind the size of the average boxroom or bedroom, which is invariably the location for most model railway activities, the layout has been designed to occupy the very minimum of space and it includes a relatively small but quite representative suburban station, running into a set of three storage or 'Fiddle' sidings. It is also specially designed to be dismantled and packed away with relative ease after each operating session. An overall size of ten feet long by six feet wide, the layout is an 'L' shape; one leg for the station and the other for the storage sidings. The layout, as was mentioned above, is semi-portable, and the ten feet long section can be folded over upon itself to form one five feet long section. This makes storage a little easier and to allow the main part of the layout to be folded away in this manner, both the scenery and the baseboard have been carefully planned. Although this does complicate things slightly, we shall give complete instructions, advising the use of tools normally available to most households. Legs are attached to the base board by bolts with wing-nuts and they are also easily

Some pictures of Bangthorn to whet your appetite! Above: the traverser section with a three-car diesel unit just leaving. Below: the same diesel set at Bangthorn station platform. Opposite page: two views of the approach to the station. Compare the pictures with the track plan. Despite the interesting layout, only six points are used

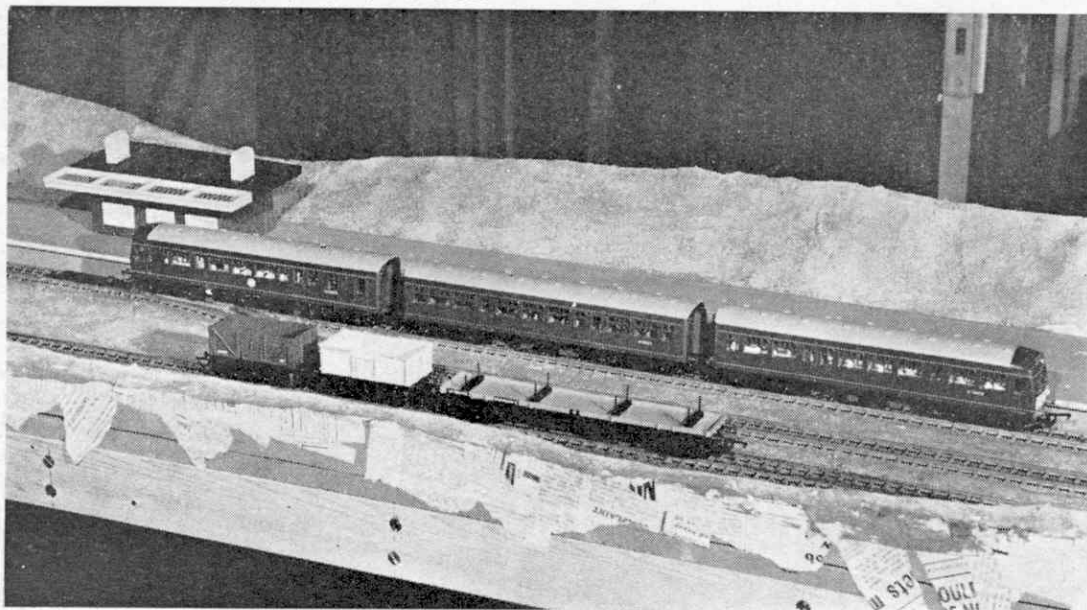

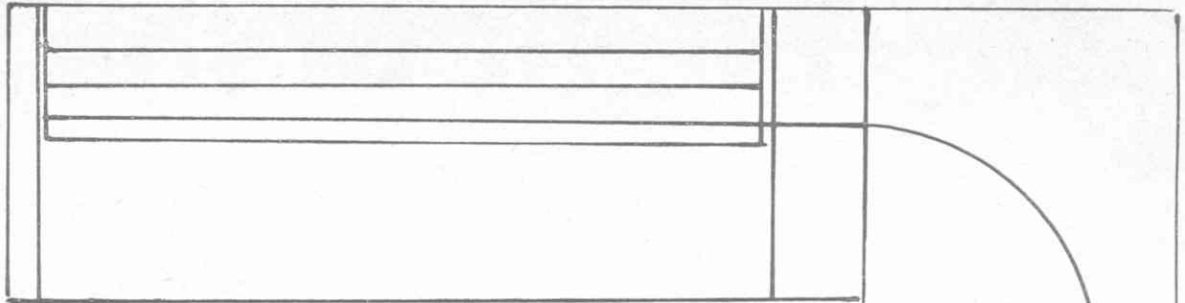

detachable for storage.

The storage sidings were also the subject of much thought and, instead of using the more usual type of storage sidings involving access points, a special traverser section not involving any points and incorporating a 'magazine' capable of storing three trains was designed. The traverser is, in fact, the key to the entire layout, for it makes operation of the station much easier and more enjoyable. It also saves a considerable amount of space. If, for example, three trains have been run in succession from the station into the storage sidings, it would normally be necessary to rearrange the locomotives and rolling stock by hand so that the locomotives once again face in the direction of the station. With the traverser section, however, all that is involved is the lifting out of the 'magazine' section containing the three trains, turning it round and placing it in the opposite direction on the traverser. The whole beauty of the traverser lies in the fact that any number of these 'magazine' sections can be built, each with three trains, so that the variety of operation is only limited by the number of 'magazines' or the amount of rolling stock.

Turning now to the plan of the layout, you will see that from the storage sidings, the train runs into a tunnel and out to the station itself. Only six points are used in the station and the design gives three sidings, one goods unloading bay, a run round and of course a main station platform. All the track is Tri-ang Super 4 and we shall give a components list, detailed plan and wiring diagram in future articles.

As illustrated in the plan, the layout will allow one train to be run at any one time, although of course three trains can be stored and used on the layout. More than one controller is not really necessary since only a maximum of two people can be occupied at any one time, one operating and the other assisting with the traverser section and the uncoupling of trains.

Scenery

Although the first six articles in this series will deal only with those stages in its construction up to the basic scenery necessary, we shall afterwards show you how to 'Gild the Lily' by making other additions, such as trees, line side structures and so on. We will also show you how to devise a timetable and how to get the best possible use from the Tri-ang Hornby range of buildings, rolling stock and accessories.

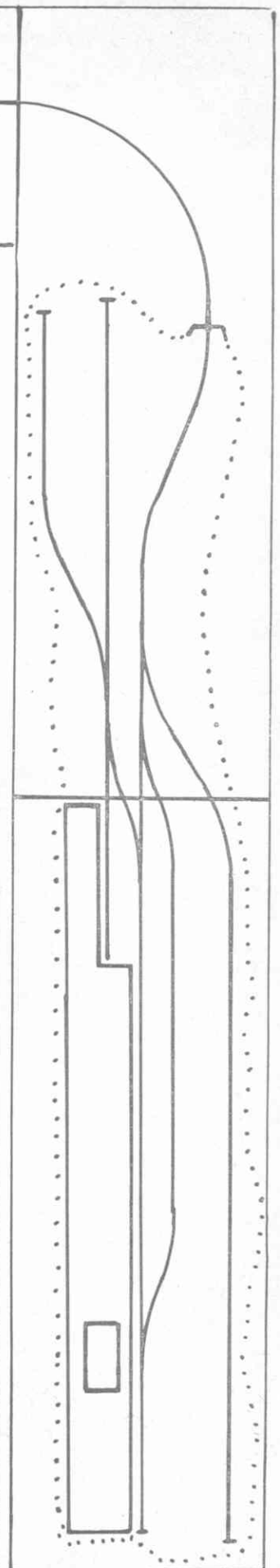
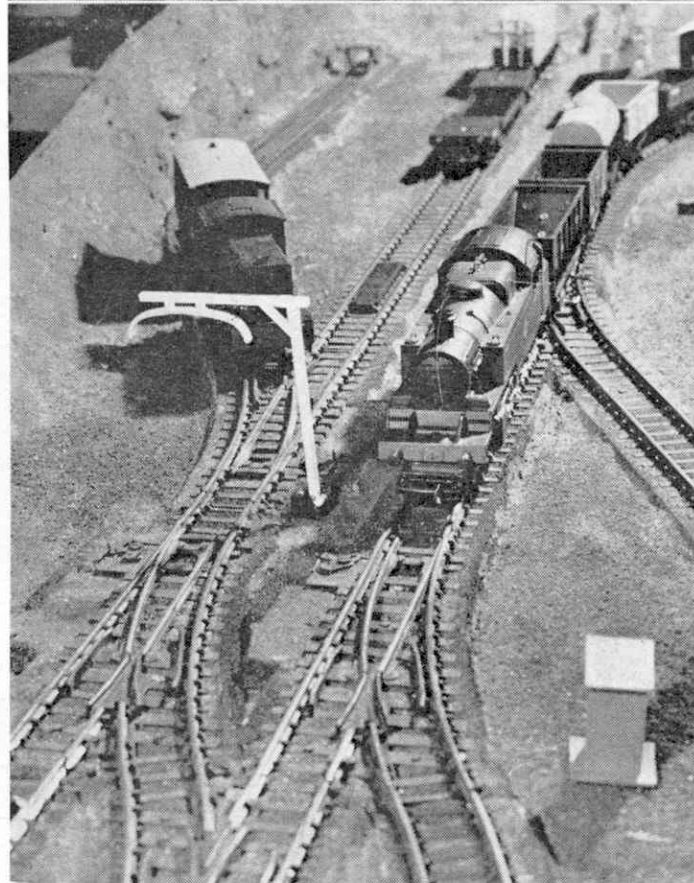
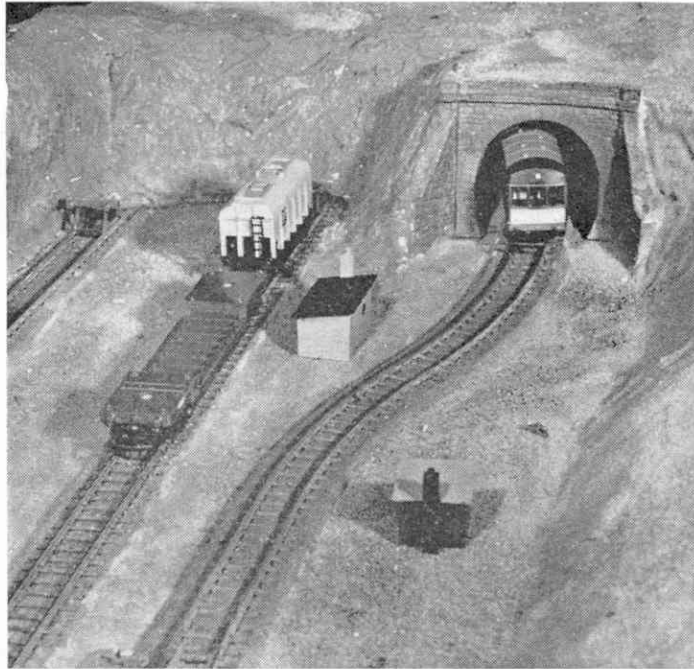

'STARDUSTER' certainly is a multi-purpose model. It will out-fly most models of a similar size and power and can, if you wish, be fitted up to do crop dusting over your flying field or even drop miniature leaflets over the nearby village! Building 'Starduster' presents no problems. Follow the 'easy-build' sketches and work from the full-size plans provided and in next-to-no time your 'Starduster' will be ready for flying duties. Perhaps you will prefer to fit the crop-dusting and leaflet dropping unit at a later stage, after you have got to know all about trimming and flying this fascinating little aeroplane.

Make sure your fuselage frame comes out square and is not twisted. Also check for warps in your wing, tailplane and fin. To avoid warps it is best to pin the frames down to your building board, using small blocks of balsa to keep the undersurfaces away from the board while the tissue is tightening. This is especially important at the final doping stage. Be careful to drill the nose block at a slight angle when viewed from the top, as shown on the plan. Cement the tailplane in place, *before* fitting the fin. If, when you come to the important business of balancing your model, you find you need some weight in the nose, fit the small radiator as detailed on the plan. This radiator makes a convenient place to hide a small piece of lead or folded cement tube. Cover the wing with five pieces of tissue, two pieces for the undersurfaces and three pieces for the top surfaces (right and left wing panels and centre section). The pilot is optional, but there is no doubt that he greatly adds to the realism of 'Starduster'. The registration lettering can be painted on with enamel paint (if you have a steady hand!) or you can use waterslide transfers obtainable in sheets from your model shop. Take care at each stage of your building and assembly, do not try and rush the construction

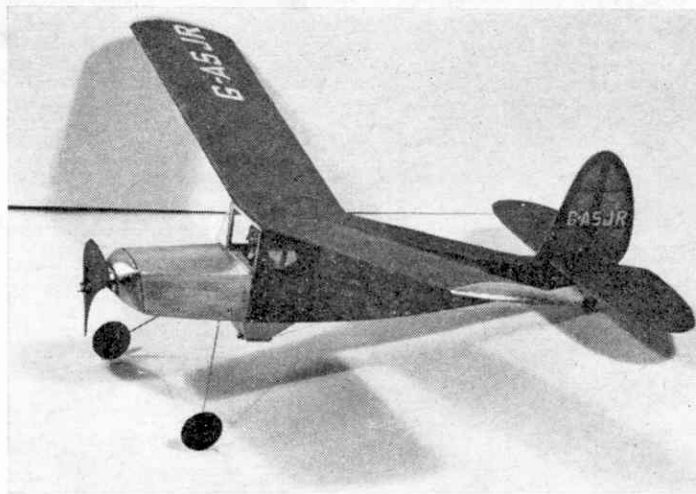

Crop-duster or Leaflet dropper that's

Starduster

a semi-scale rubber powered model
aeroplane by Ray Malmström

and you will be rewarded by a model that not only looks good, but will fly well.

Flying: Install the rubber motor and balance your model as shown. For testing, choose a calm day and some soft grass, then launch 'Starduster' from about shoulder height into the wind. It should glide straight and land about 20-25 ft. away. Turns to left or right can be corrected by *gently* warping the fin

in the opposite direction to the turn. (Model viewed from the rear.) If your model stalls (rears up in a steep climb, falls back on its tail and then dives), add some weight to the nose. If it dives straight into the ground without first climbing, gently bend up the rear edges of the tailplane ($\frac{1}{16}$ in. approx.).

Having obtained a shallow straight glide, connect the free-wheel clutch pin with the winding

hook on the propeller shaft and wind up the motor about 150-200 turns. Please remember to rub special rubber lubricant (6d. a tube from your model shop) into your motor before putting turns on it. *Never* allow oil to come into contact with rubber or it will quickly perish. Launch gently, as before, but let the propeller spin for a second or two *before* releasing 'Starduster'. If, under power, your model flies downward into the ground, stick a small piece of $\frac{1}{16}$ in. square balsa strip along the lower edge of the noseblock. If it stalls, cement a $\frac{1}{16}$ in. square strip along the upper edge of the noseblock. These adjustments alter the angle of the propeller driving shaft (as viewed from the side) and will correct a dive or stall under power without affecting the glide adjustments that you made earlier. When you want to use the crop-dusting leaflet dropping equipment make sure that the rear rubber anchorage dowel rod moves easily in its slot, and that the small dowel rod holding the hopper door closed moves freely in its tape mount. A tiny piece of lead cemented to this door will help it to open easily. Make sure there is no cement or dope on the tape hinge. If there is, it will become stiff and the hopper door will not open. For crop-dusting, you can fill the hopper with flour or yellow powder paint (we have also used 'Ready-Brek' and cold-water paste!). For leaflet dropping cut up some small ($\frac{1}{4}$ in. square approx.) pieces of paper, or use small pieces of coloured confetti. As a rule the hopper door opens towards the end of the flight. You will have to make adjustments to the rubber band that operates the rear-anchorage dowel rod to achieve the best moment for dropping. The tighter the band, the sooner the hopper door will open and vice-versa. As we found out when testing the original 'Starduster', this little model is lots of fun, so—good luck and Happy Flying!

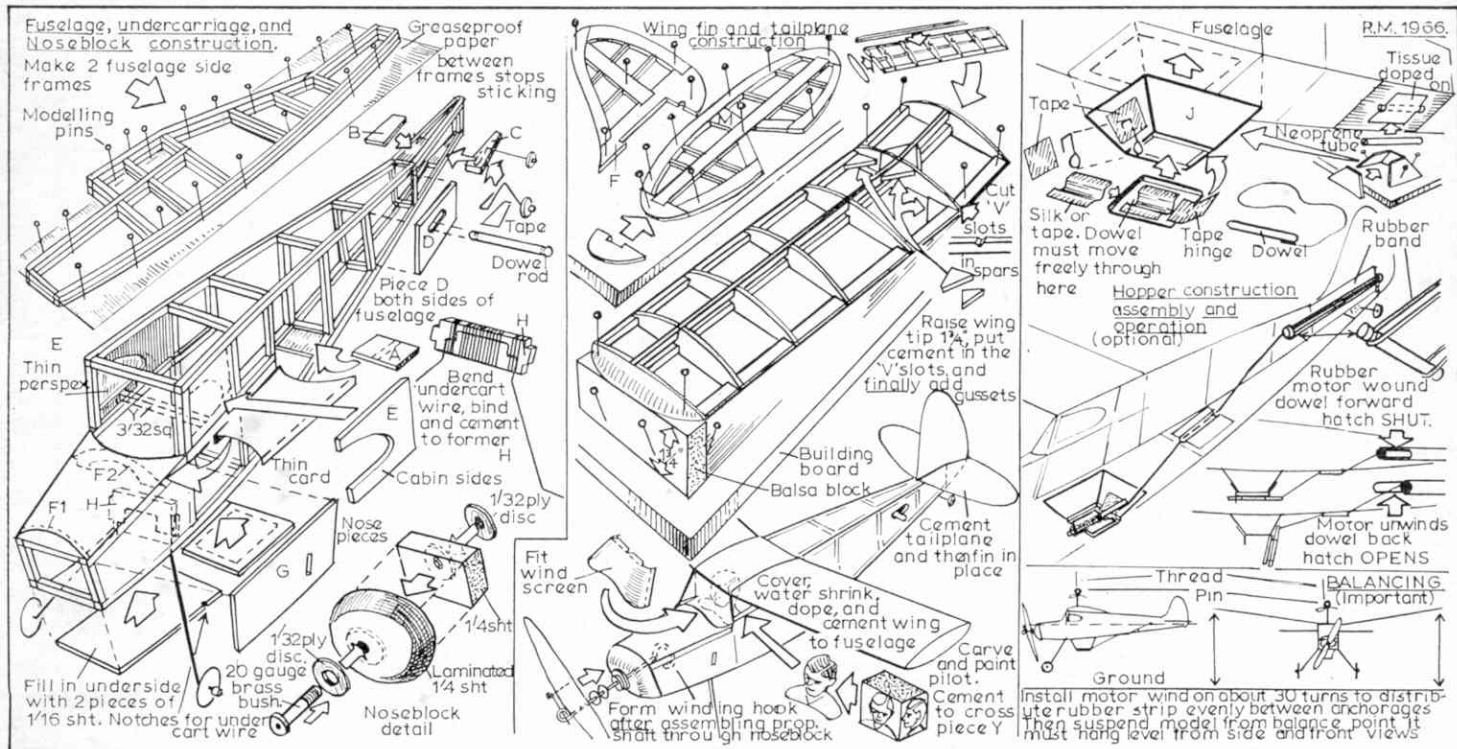

Starduster materials list :

8 lengths 36 in. by $\frac{3}{8}$ in. sq. balsa strip ● 1 sheet 36 in. by 3 in. by $\frac{1}{16}$ in. balsa ● 1 length 12 in. by 3 in. by $\frac{1}{4}$ in. balsa ● 1 small piece 12 in. length of 22 gauge piano wire ● 2 cup washers 20 gauge ● 1 brass bearing bush 20 gauge ● 1 pin ● 1 pair 1 in. diameter propellers (colour to own choice) ● Small piece of thin card ● Small piece of thin perspex or clear celluloid ● 1 medium size tube balsa cement ● 30 in. $\frac{1}{8}$ in. wide rubber strip ● 1 rubber tube lubricant ● 6 in. diameter Keil Kraft hardwood propeller. ● Powder or poster colour (

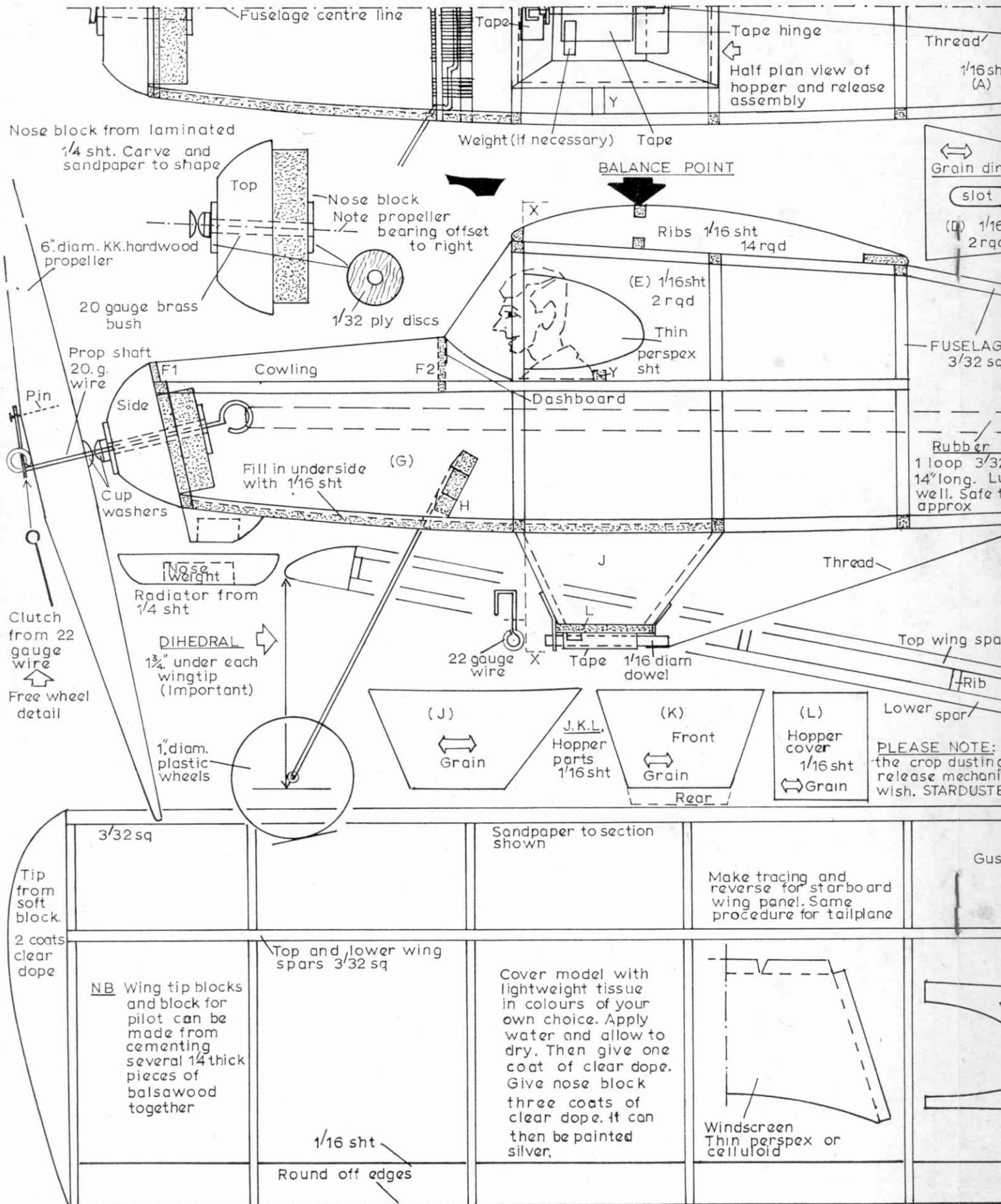

- 1 small piece $\frac{1}{8}$ in. plywood
- 2 in. length of $\frac{1}{8}$ in. diameter hardwood dowel.
- 1 in. length of $\frac{1}{8}$ in. hardwood dowel (or rounded matchstick)
- 18 in. length of 20 gauge piano wire
- $\frac{1}{8}$ in. diameter plastic wheels
- Short length of neoprene tubing
- Short length of electric tubing
- 6 in. length of $\frac{1}{2}$ in. wide linen tape or silk
- 18 in. thread
- 1 sheet lightweight tissue
- Balsa cement
- 1 small tube tissue paste
- 1 small size bottle clear dope
- Small amount of silver dope (for nose sheeting cowling and noseblock)
- 1 3 in. length approx. (rubber band)
- poster colour (for pilot if fitted).
- Sheet of waterslide transfers (registration lettering).

