



CHALLENGE OF THE 'WAPITI'

The Westland Wallace is remembered for its record breaking flight over Everest, and the thrilling story of this adventure is told on page 14. The Frog 'Trailblazer' 1/72nd scale kit of the Wallace forms the basis of our plastic conversion this month, in which Doug McHard shows you how he produced from it a Wapiti—one of the most colourful and widely used R.A.F. aircraft of the '30s.

For our conversion, the wings and tail remain basically unaltered, and all the *essential* work involves the fuselage and undercarriage. But since the Wapiti engine, unlike that of the Wallace, is not enclosed in a cowling ring, and is a prominent feature of the machine, much of our article deals with the development and embellishment of this item, however, if you want to simplify the job, you can simply use the original Wallace engine moulding without the cowling ring.

Ian Stair's fine drawing on the facing page reveals a lot more Wapiti detail which expert modelers might wish to incorporate in their own conversions. A close study of these photographs of the Editor's model will provide the inspiration—now read on!

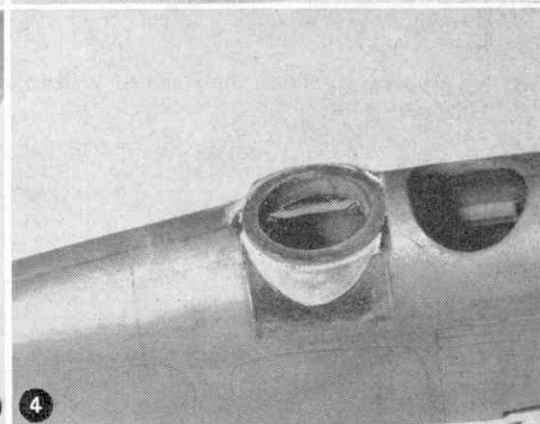
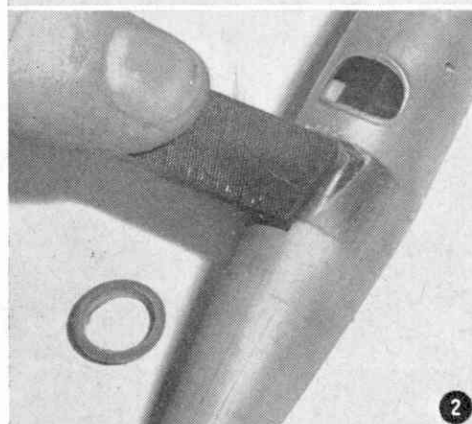
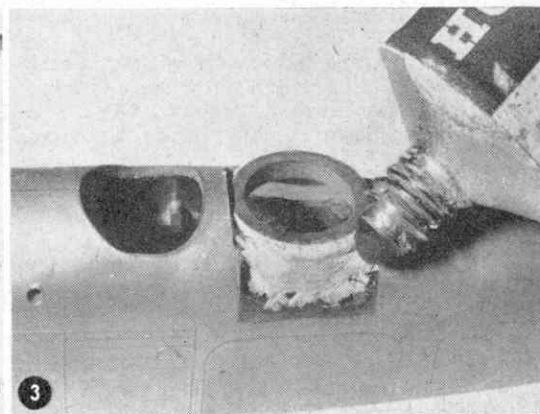
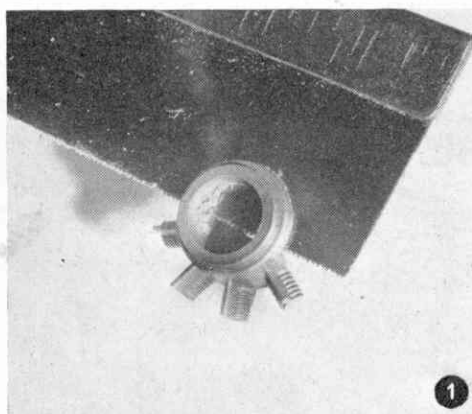

1 First job is to saw the rear rim off the engine moulding. This piece later becomes the rear cockpit gun-mounting ring, so don't throw it away!

2 The fuselage halves and the rear transparency are allowed to dry *thoroughly* and the top of the transparency is then filed flat (see drawing).

3 With a sharp knife, cut a hole to take the small diameter rim of the cut-off rear engine

ring, allowing the lower face of the larger diameter part to rest on the flat-filled rear transparency. Now apply Humbrol Body Putty as shown—more than required to allow for shrinkage—and let it dry overnight.

4 Using No. 280 and 400 wet or dry paper, shape the putty as shown, leaving a narrow lip round the top edge, 'open out' the cockpit and gun mount ring with a round file or 280 paper wrapped round a pencil.

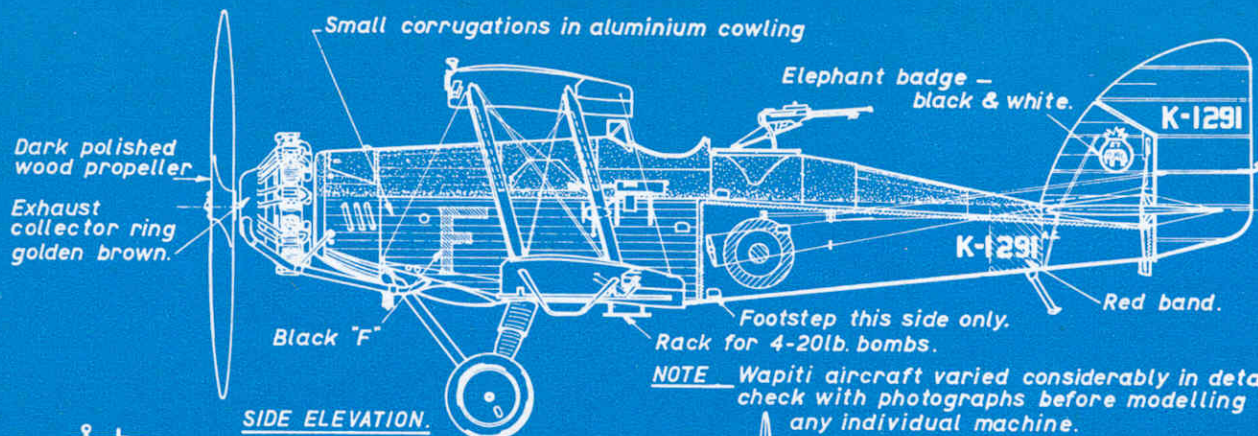

NOTE Wapiti aircraft varied considerably in detail, check with photographs before modelling any individual machine.

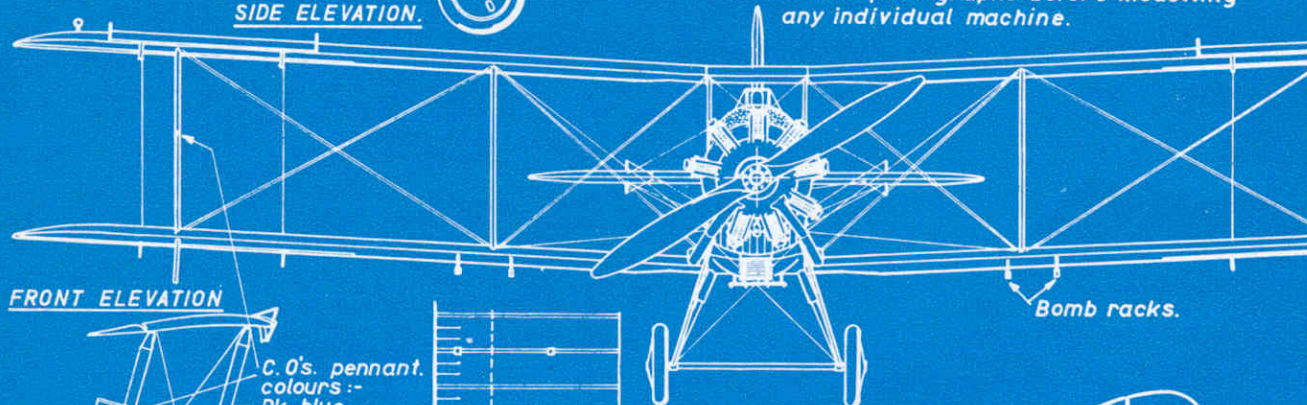

FRONT ELEVATION



SECTION AT OUTER STRUTS

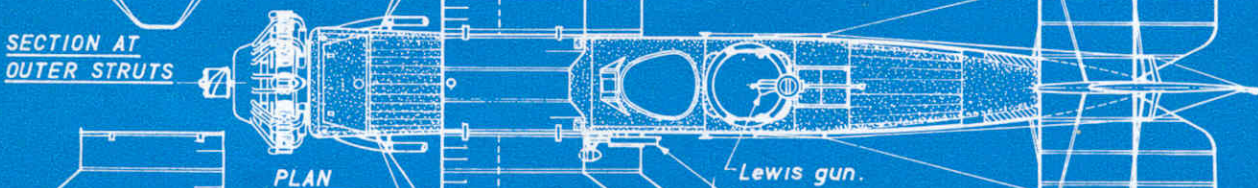

PLAN

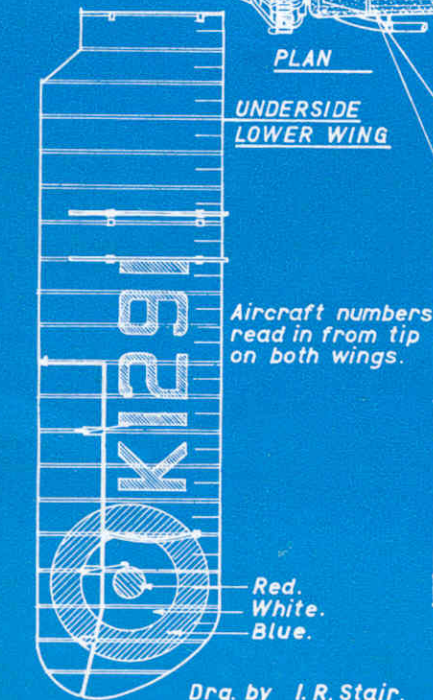

UNDERSIDE LOWER WING

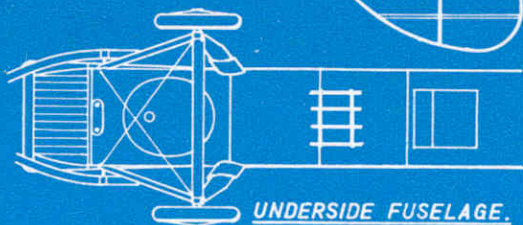

UNDERSIDE FUSELAGE.

WESTLAND WAPITI Mk IIA.
BRISTOL JUPITER ENGINE.

K.1291. - Commanding Officers aircraft No. 27 (Bomber) Squadron, Kohat, India, 1936.

COLOURS :-
Wings, rear fuselage, tail unit - silver.
Forward fuselage, undercarriage - bright aluminium. Fuselage top - dark grey.
Struts, guns, tyres, engine, exhaust pipes, oil cooler, bomb racks, - black.

Drg. by I. R. Stair.

SCALE 0 5 ft.

CHALLENGE OF THE WAPITI

5 With a sharp knife, cut off the small 'buttresses' on the front of each cylinder.

6 You will need several pieces of thin plastic 'rod' and these are made by heating a piece of spare 'stem' in front of an electric fire and when it becomes very soft, it is gently 'drawn out' using a pair of pliers. Hold it straight until the plastic cools. With a little practise rods of any diameter can be produced by varying the heat and speed of draw.

7 File the grooves back into the front of each cylinder and then drill two 1/32nd diameter holes ahead of each one, angling them back as shown.

8 Insert a piece of drawn plastic rod in each hole and fix in place with a touch of liquid plastic solvent such as Slater's Mek-Pak. Snip off the surplus rod with a pair of nail scissors.

9 Small pieces of slightly larger diameter rod are cemented to the end of each cylinder to represent rocker boxes.

10 Here's the completed engine fixed to the modified fuselage. In addition to the operations described above, the Wapiti fuselage is shortened by trimming 1/8th in. from the rear end. The rear of the top fuselage decking is then filed down to meet the more forward-set tailplane position. The un-modified Wallace fuselage and cowling ring is shown in the background.

11 This photo shows the standard Wallace undercarriage and engine assembly.

12 Three stages in the development of the Wapiti main undercarriage leg from the Wallace one on the left. The thickened upper leg is built up by wrapping the pared-down leg with thin paper.

13 On the new undercarriage, the rear struts become the front ones, and two 3/32nd in. holes should be drilled in the fuselage to take them. 1/16th in. holes drilled in the wing roots take the main rear strut ends and a new axle is made from one of the thicker plastic drawn rods. The new exhaust pipes are also made from this material.

14 The detail makes the difference! It's mostly made from stretched plastic rod and the rigging is Kleintex 'Invisible Thread'. This is a synthetic monofilament, and its slight elasticity keeps it nice and tight. The ends are simply tied to the struts. For certain jobs where wire is to be represented, the 'thread' can be successfully painted silver and, of course, unlike ordinary thread, it cannot go 'furry'. Buy it in any good milliner's. The numeral transfers are from the Yeoman range.

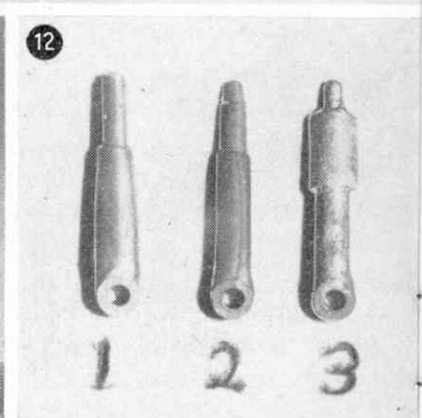
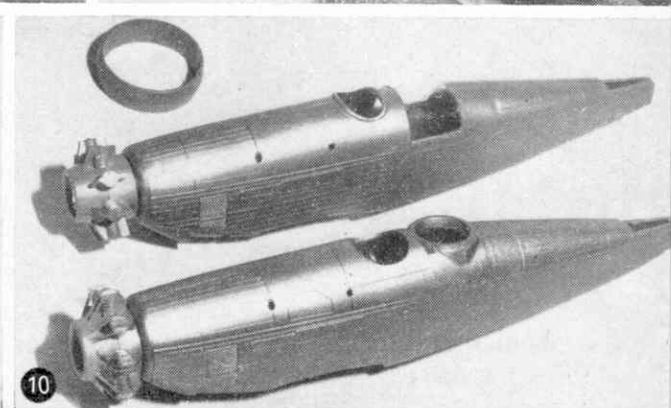
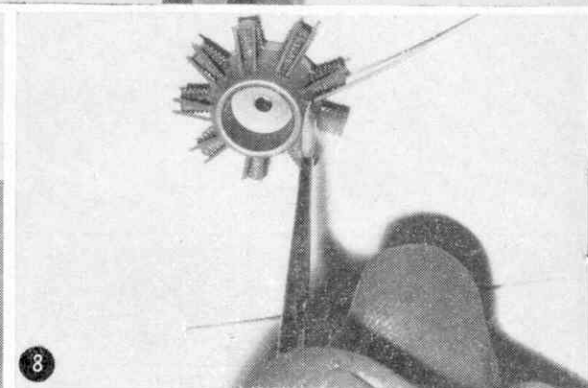
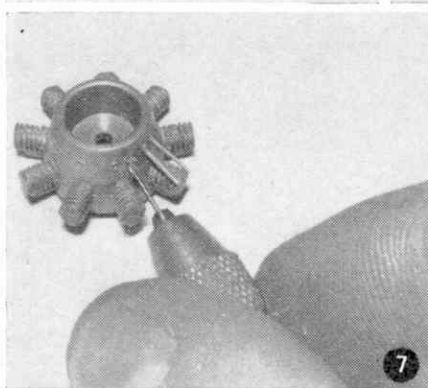
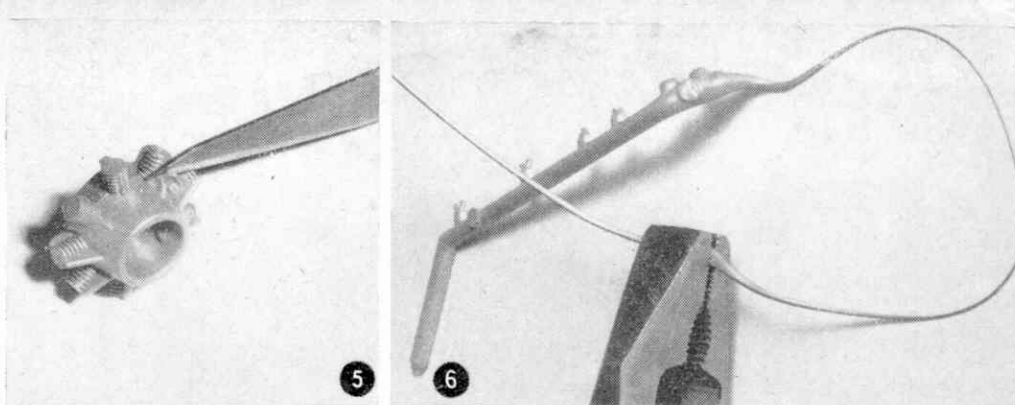

What IS a Wapiti?

A Wapiti is one of the many aircraft described in a series of brilliantly-presented full-colour "Profile" booklets by world-famed authors and illustrated by top-class artists, covering the whole development and service history of aeroplanes and featuring numerous rare and carefully selected photographs.

Send 2/6 for sample Profile and list of titles available, or place your order (at 2/- each) through your local hobby dealer or bookseller.

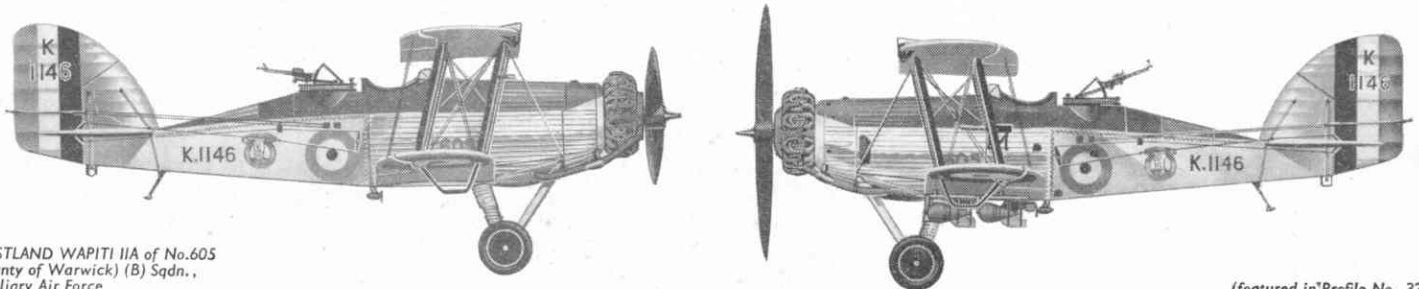

WESTLAND WAPITI IIA of No.605
(County of Warwick) (B) Sqdn.,
Auxiliary Air Force

(featured in Profile No. 32)

FOR FLYING COLOURS DOWN THE YEARS . . .

Read Profiles!

PROFILE PUBLICATIONS LTD., P.O. Box 26, 1A North Street,
Leatherhead, Surrey, England

START OFF RIGHT with a

KEILKRAFT model aircraft kit!



PHANTOM MITE

Just about the toughest model available to the newcomer to control line flying. Features all sheet construction with wings, tailplane and fuselage sides ready cut to shape. Suitable for .5 to .8 c.c. motors. Wingspan 16 in.

17/9



SNIPE

This nice looking model is especially suitable for beginners as it is so straightforward to build and easy to fly. Kit contains die-cut parts and has been specially designed for .5 diesel and .8 glow motors. Wingspan 40 in.

24/3

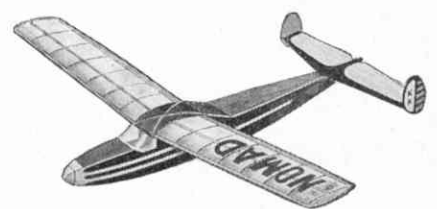

NOMAD

Beginner's model with fuselage parts, tailplane and fins in pre-cut, decorated sheet balsa. 20 in. span.

5/11

See this famous
range at the
local model shop

CONQUEST

Towline glider for beginners, with a very good performance. Kit contains die-cut parts. Wingspan 30 in.

9/4



THERE ARE OVER 100 KEILKRAFT MODELS

KEILKRAFT

RIGHT from the start!