

CHINESE SOUTH-SEEKING CHARIOTS

by Noel C Ta'Bois

TO enable the Chinese to navigate to the sunny south before the invention of the compass it is thought that they used south-seeking chariots. These are vehicles having two wheels connected by gearing to a vertical rod on top of which is a pointing figure set to indicate south and remaining so no matter in what direction the chariot is driven, providing the wheels remain in rolling contact with the ground. Articles on the subject appeared in the MMs for September 1955, January 1957 and January 1977 describing models using ten or eleven gears.

It is not essential to use as many, and in January 1978 the MM offered a prize for the chariot using the lowest possible number. The writer submitted an entry consisting of a treatise on south-seeking chariots, in which the theoretical principles were illustrated by models using progressively fewer gears, the final two gear version being the winner. It is possible to build a gearless chariot but the wording of the competition would have disallowed it as an entry. This article is a shortened and modified version of the treatise and also includes with permission some gratefully acknowledged additional material from John Nuttall and Alan Partridge.

THEORETICAL PRINCIPLES

Fig. 1 shows the plan view of a chariot, the body being represented by a rectangle. Two wheels 1 and 2 of diameter D_1 and D_2 , spaced apart by distance X , are mounted on diametrically opposite axles and independently drive the pointer P , fixed to a vertical rod, through gearing of ratios R_1 and R_2 respectively.

The gearing must be such that the pointer rotates in the opposite direction to that in which the chariot turns ... (1). For example, if wheel 1 turns in the direction shown by the arrow and wheel 2 is stationary the chariot will pivot about point C in a clockwise direction, so the gearing must turn the pointer in an anti-clockwise direction.

Wheel 1 follows the path shown by the dotted circle, and if the spacing between the wheels is made equal to D_1 then, because the radius of the dotted circle equals the diameter of the wheel, the circumference of the dotted circle will be twice the circumference of the wheel which will therefore rotate twice for a 360 degree turn of the chariot. So R_1 must be 2:1 step down if the pointer is to appear stationary.

If X is less than D_1 the wheel will turn less than twice, and R_1 must be proportionately less than 2. Similarly if X is greater than D_1 , R_1 must be proportionately greater than 2. The same argument applies to D_2 and R_2 . It is not essential that the wheels are the same size or that X equals D_1 . The chariot will function correctly provided that condition (1) is satisfied and that $D_1 \times R_1 = D_2 \times R_2 = 2X \dots (2)$.

This is confirmed by the model shown in Fig 2 which has unequal wheels (for use on hill-sides?). The 2" Pulley with Tyre (3" diameter) transmits the drive through a 4:1 ratio and the 3" Pulley with Tyre (4" diameter) through a 3:1 ratio. As $4 \times 3 = 3 \times 4 = 2 \times 6$ the chariot functions correctly with the wheels 6" apart. Further constructional details of this model are given later.

Fig. 6.

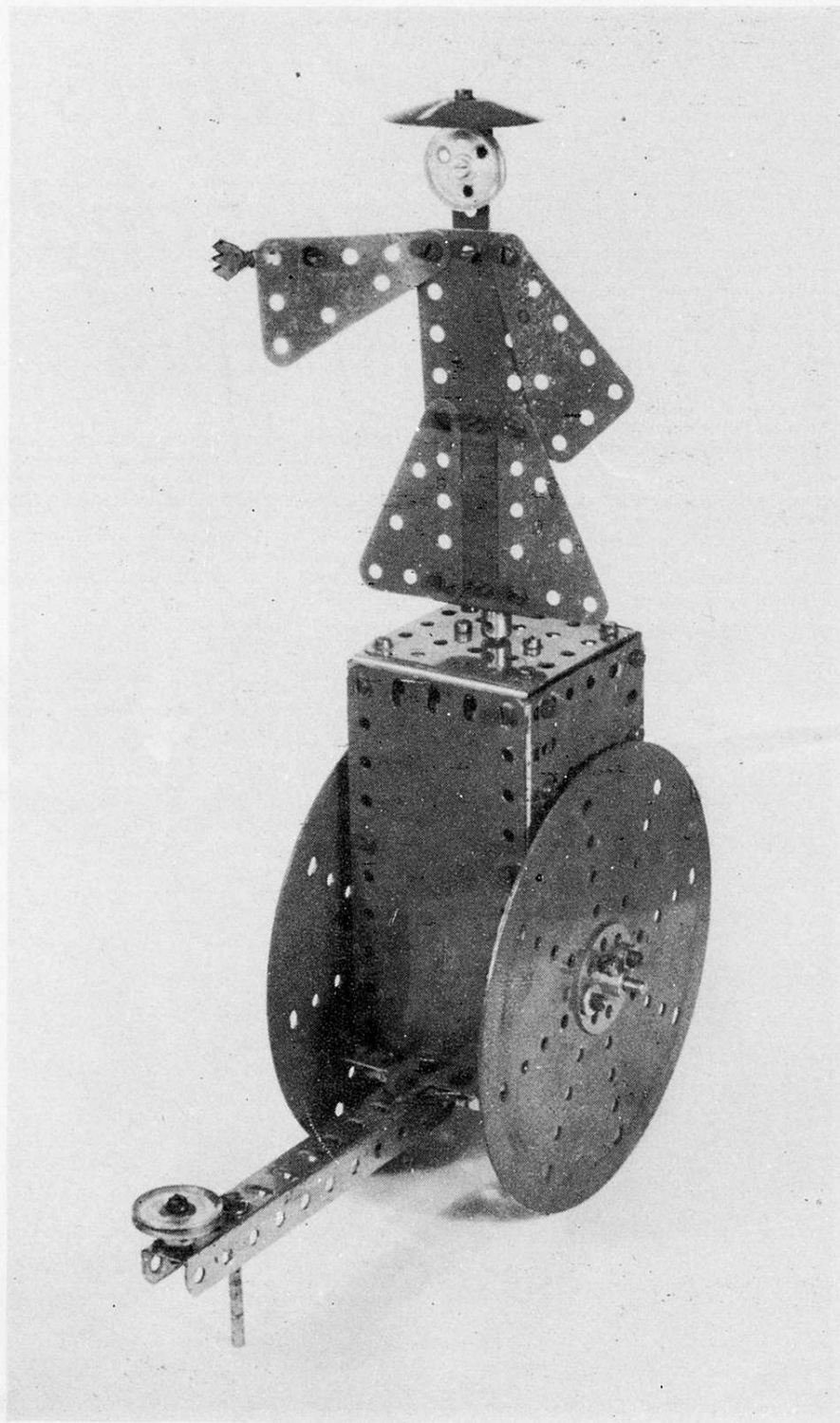

Note that there is nothing in equation (2) to relate the distances of the two wheels from the centre of the chariot. It is not necessary, just as it is not necessary to specify the position of a differential gear in the driving axle of a road vehicle.

If the wheels are the same size, as they normally will be, then R_1 and R_2 must be made equal and (2) can be modified to give the very simple formula, which can be used to check the wheel spacing of any model, $X = D \times R \div 2$. (3) where X is the wheel spacing, D is the wheel diameter and R is the ratio of the gearing between either wheel and the pointer.

Fig 3 shows a fascinating little seven gear chariot to a design by John Nuttall in which $R = 4$ and therefore the wheel spacing is twice the wheel diameter. The only components fixed to the $5\frac{1}{2}$ " Rod on which the model is built are four Collars, one at each end to hold the vehicle together, and the two which carry the Pivot Bolts for the $\frac{3}{4}$ " Contrates. By turning this model upside down one can demonstrate the effect produced by not complying with condition (1).

DESIGN PRINCIPLES

If $X = D$ formula (3) shows that R must be 2:1. This ratio can be obtained either from a differential gear which needs four or three bevels or, more economically, from an epicyclic gear with two pinions of equal size as in Fig 4. Rod A turning in the boss of Bush Wheel C carries a $\frac{1}{2}$ " Pinion meshing with a similar Pinion on Rod B which passes through one of the outer holes of the Bush Wheel. Hold A and rotate B and Pinion B will ride round Pinion A and turn C at half the speed of the rotation of B. Hold B and rotate A and C will again turn at half speed.

By connecting A to wheel 1 of the chariot, B to wheel 2 and C to the pointer, independent drives to the pointer will be satisfied as also will be equation (3) but not condition (1) because the wheels rotate in opposite directions. Furthermore the pointer, connected to wheel C will not be rotating on a vertical axis. Therefore to make a workable chariot modification is necessary and the following would seem to be the essential gear requirements:

- (i) Two epicyclic pinions 1:1 ratio.
- (ii) Two pinions 1:1 ratio to reverse the direction of rotation of one of the wheels, which one being determined by condition (1).
- (iii) Two bevels, or a contrate and pinion 1:1 ratio for a right-angle drive to the pointer.

Total six gears. By using a contrate for (iii) the pinion meshing with it can be one of the pinions of (i) thus reducing the total to five. A chariot using this number is shown in Fig 5. Because A and B (Fig 4) are not in line it is more practical to up-end the epicyclic mechanism and provide two right-angle drives to the wheels as in Fig 5 where the axle of the right-hand wheel has a $\frac{3}{4}$ " Contrate meshing with

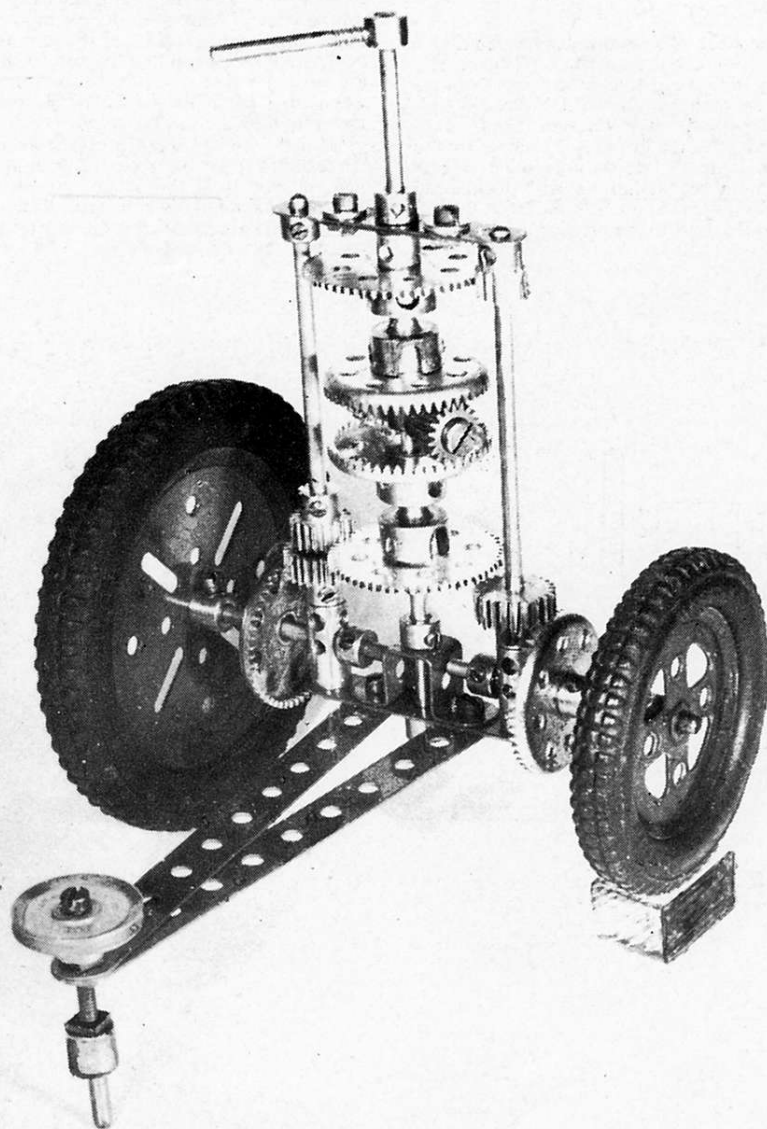

Fig. 2.

the first $\frac{3}{4}$ " Pinion of the epicyclic gear (this Pinion is free on the Rod) making a ratio of 1:1 i.e. $R = 1$. Applying this to formula (3) gives

$X = D \div 2$, so the spacing between the wheels must be half their diameter, and as they are 6" Circular Plates they must be 3" apart.

The drive from the left-hand wheel is 2:1 step down through a $\frac{3}{4}$ " Pinion and a $1\frac{1}{2}$ " Contrate on a centrally placed vertical 3" Rod to the top of which a Collar is anchored by its Grub Screw. A Handrail Support, fixed to the Collar by a Nut, forms the bearing for a 1" Rod carrying the second $\frac{3}{4}$ " Pinion of the epicyclic pair, which give a step-up ratio of 2:1 resulting in the required overall 1:1 ratio to match the drive from the right-hand wheel. The orbital motion of the outer epicyclic Pinion is transmitted to the pointer through a linkage consisting of two $\frac{1}{2}$ " Reversed Angle Brackets connected by locknotted Bolts to two 1" Corner Brackets secured to Rod Sockets on the driving and driven shafts.

Alan Partridge has designed an enclosed version of this chariot with a delightful Meccano Chinaman perched on top. The model shown in Fig 6 is similar.

Is it possible to use less than five gears? Study of the gear requirements mentioned above suggests that (ii) can be replaced by crossed connecting rods (and the 'Chuff-chuff' competition results, MM January 1978 page 35 Fig 8, show how to do this with only one pair of cranks) and as Meccano Universal Couplings work quite nicely at 45 degrees, two in tandem can be used to replace (iii) Thus only two gears are

Fig. 3.

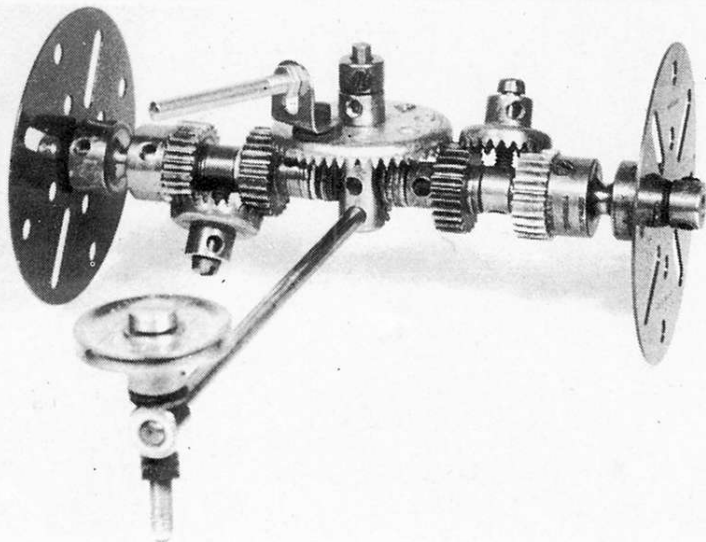

required. Fig. 7 is a photograph of such a model, with up-ended epicyclic gear and two right-angle drives. Another view was shown in the MM for April 1978 page 75.

A miniature Meccano Chinaman holding a pointer is mounted on a Bush Wheel corresponding to C in Fig 4, and the drives from the wheels are taken via pairs of Universal Couplings above and below through 'Chuff-chuff' competition result linkages 7 and 8 to the epicyclic Pinions. Two six-hole Bush Wheels united by three Fishplates with locknutted Bolts pivoting in the holes of the Bush Wheels transmit the drive to the orbiting epicyclic Pinion.

IN CONCLUSION

A 1" Pulley pivoted on a Bolt on the tow-bar of each model facilitates testing by running the vehicle round in circles in one direction only, when small errors add up and are readily detected. If it is found that the pointer drifts in the same direction as the chariot is turning, the wheels are too close, and if in the opposite direction they are too far apart.

Of all the models, apart from the competition viewpoint, Fig 2 is probably the most interesting because it is the most versatile. Two Threaded Couplings bolted vertically to a 2½" Strip provide the bearings for the vertical Rods carrying the required Pinions, and also the

bearings for the wheel stub axles which can be made any required length. Fixed to the middle of the 2½" Strip is a Double Bent Strip providing support for a vertical 6½" Rod carrying the pointer.

All components on this Rod are free to rotate except for the retaining Collars and the 'Spider' carrying the two Pivot Bolts for the Pinions of the differential gear, the Contrates of which are joined by Socket Couplings to the Gear Wheel so that other sizes can be easily substituted as required. Gear ratios, wheel sizes and wheel spacing can all be readily varied to enable the principles of south-seeking chariots to be studied in detail.

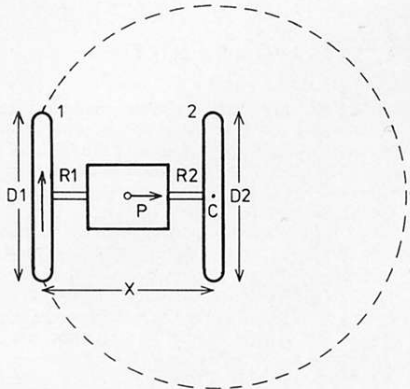

Fig. 1.

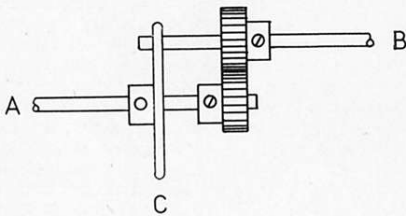

Fig. 4.

Fig. 5.

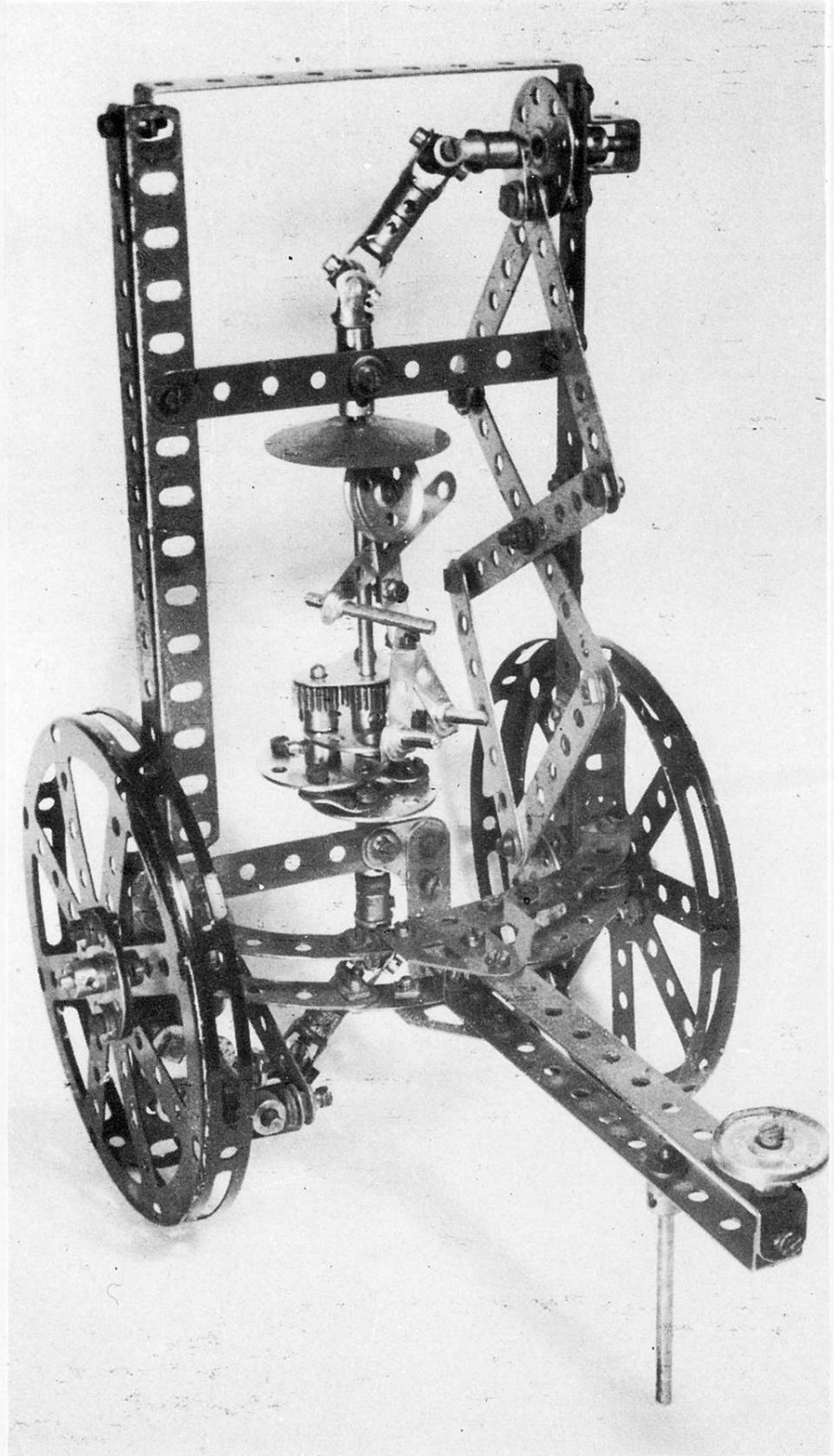
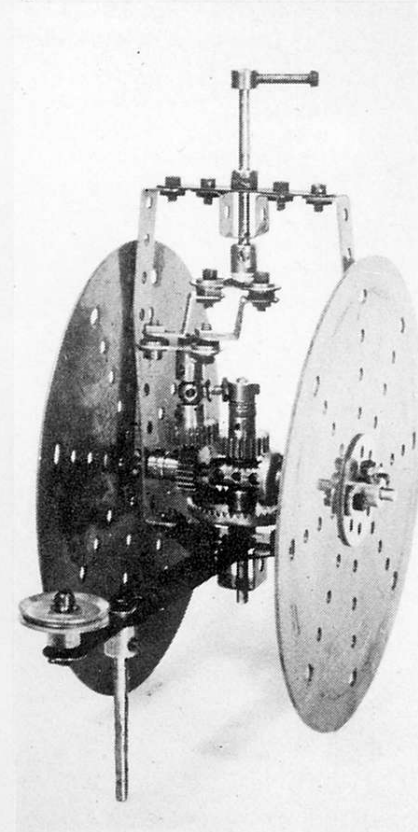

Fig. 7.