

JUNE 1924

# MECCANO

## MAGAZINE

PRICE

2<sup>D</sup>

VOL. IX  
Nº 6

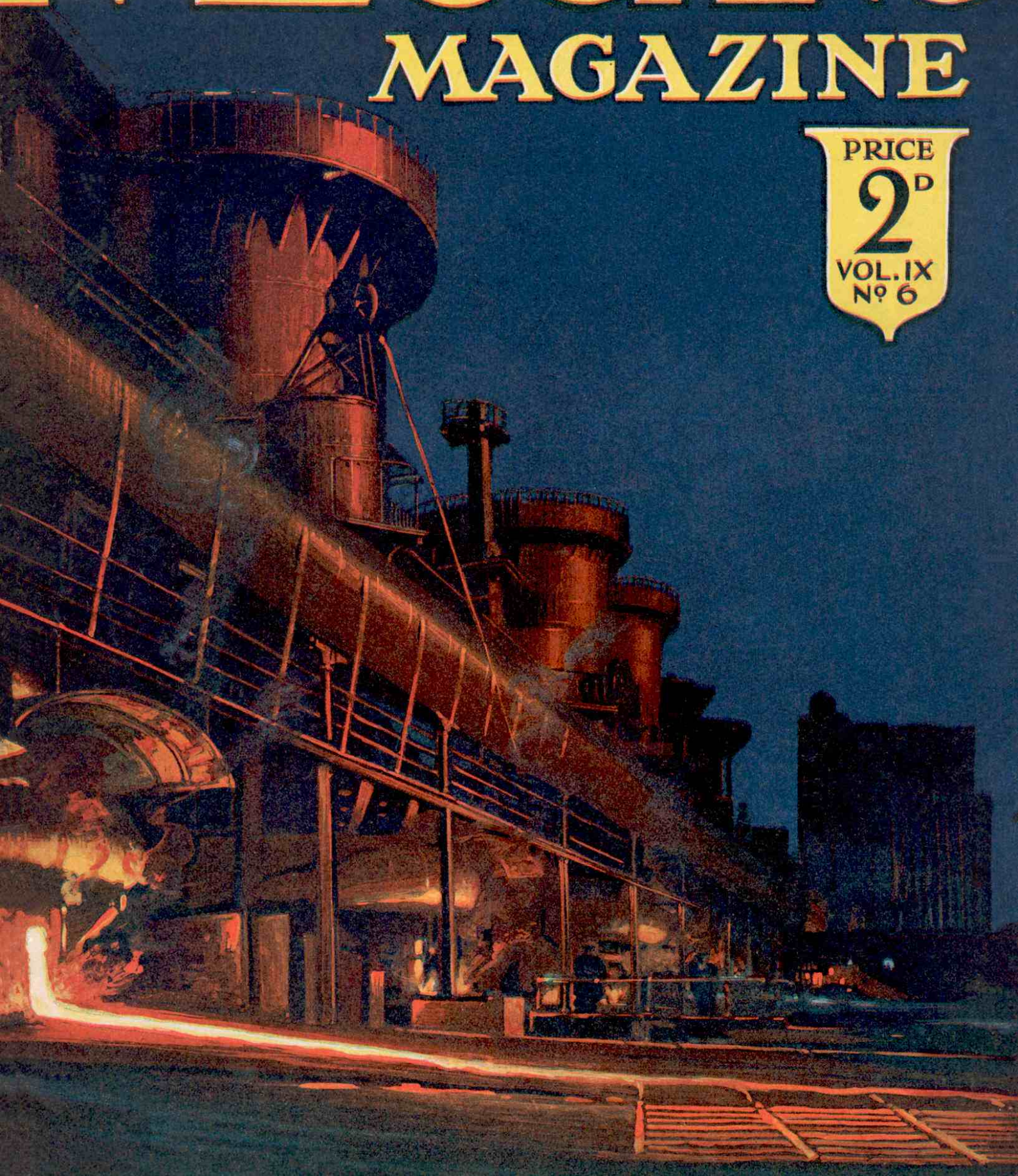



Water and 'meth'—  
and away she goes!

Hours of joy for any boy!

Here's a lovely Launch for you—one of which you will be proud and the other boys envious. She has a real engine which generates a nice turn of speed and keeps the boat going for 20 or 25 minutes with one filling. You can't get such splendid value anywhere else—it beats the German boats hollow.

# PEGGY

The Launch of Speed and Beauty

*The hull is 31 inches long with a 4½ inch beam. The boiler and engine are of brass and the firebox encased to obtain greatest heat in a short time. The exhaust pipe to stern creates a realistic "tuff, tuff," and the boat can be guided by the movable rudder and tiller. The boat is beautifully finished in three colours and the power unit is strong, safe and simple.*

**FREE** A fully-illustrated 16-page Catalogue will be sent free upon application, or can be obtained at any branch or agent.

**HOBBIES LIMITED**

*Peggy Dept. - DEREHAM - NORFOLK*

*And of all Branches and Agents in every town.  
Write for nearest.*

Complete  
with Lamp,  
Filler and  
Instructions

# 22/6

*Postage 9d. extra.*

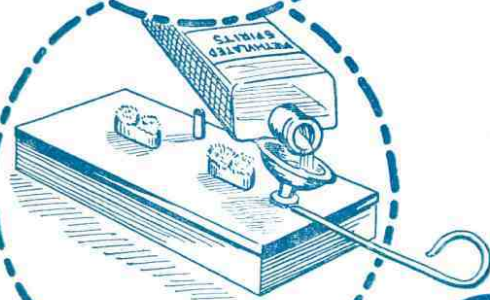
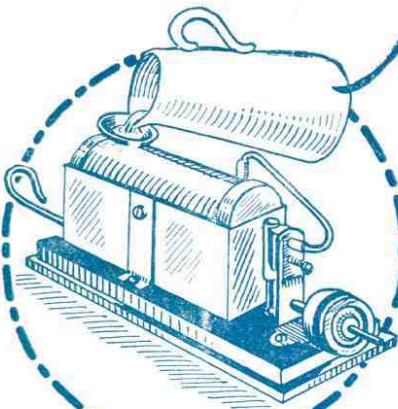

**British  
Made**

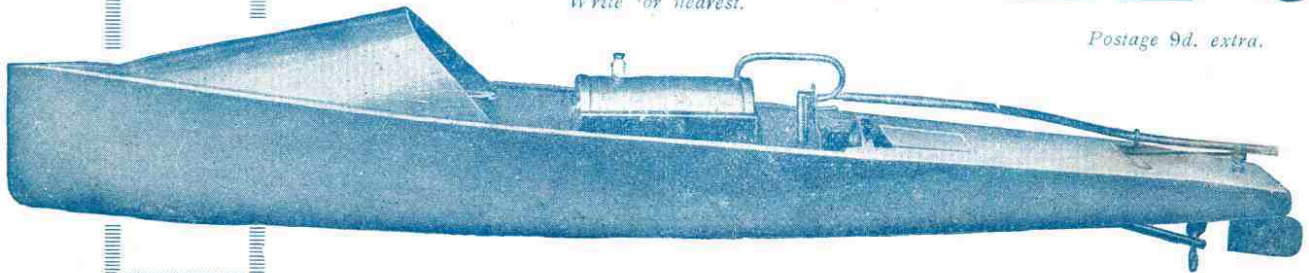

EDITORIAL OFFICE

Binns Road,

LIVERPOOL

# MECCANO



# MAGAZINE

PUBLISHED  
IN THE INTERESTS  
OF BOYS



## EDITORIAL

I WOULD thank those hundreds of readers who have written to me during the past fortnight, saying delightful things about the cover of our May issue. As I mentioned on this page last month, I am having some beautiful covers prepared for our future issues, and no expense is being spared to make the cover of the "M.M." worthy of the Magazine and all that it stands for. This month the subject of our cover is a blast furnace, which is described in detail in our new serial feature, "The Story of Iron and Steel." The cover shows a row of blast furnaces by night, one of which is discharging the molten metal. As a very small boy I well remember being taken by my father to see his furnaces discharging their glowing contents, and the sight was one I shall never forget! I was vividly impressed by the intense light of the furnace-mouth, by the smoke and steam, and by the terrific heat. Here molten metal was running along channels in the sand as easily as water runs along a furrow, making it difficult to realise that in a few hours' time the glowing stream from the furnace would become hard and solid iron. If any of my readers ever have an opportunity of seeing the wonderful sight that forms the subject of our cover, they should not miss it for worlds!

Our  
Covers

The large number of letters I receive every day, covering almost every topic under the sun, fully bear out my contention that Meccano boys are more observant and more keenly interested in the daily happenings in the world around them than are other boys. Most of the letters I receive contain at least one point of general interest. One may be a new idea for making something—not necessarily a Meccano model—and another a method of doing something in a new manner. Or there may be an account of some unusual occurrence or incident, such as what it feels like to be in a sand-storm, or to win a cup on sports day, each of which experiences formed the subject of recent letters from two of my correspondents.

New  
Experiences

One of the main objects I always have in view in editing the "M.M." is that of keeping every Meccano boy informed of just such matters as are covered by these letters; to tell them, in short, "what other Meccano boys are thinking and doing." I have not the time to do this as thoroughly as I wish, and therefore I intend to call upon Meccano boys to help me. My plan is that each Meccano boy who at any time has a new idea to put forward, or an interesting experience to describe, should write it down in the form of a short article, and send it to me, marking the envelope "Ideas" in the left top corner. Articles should not be longer than 500 words, and they should be written as neatly as possible and on one side of the paper only. Those articles that are likely to prove of general interest to my readers will be published in a special page each month and paid for at our usual rate. Illustrations may be sent, if desired, either drawings or photographs.

Ideas  
Wanted

I want to make it quite clear that no boy need hesitate to send in an article because he may not be very good at composition. So long as he states the facts clearly, I will, if necessary, have his article put into proper shape, ready for publication.

I have recently returned from a visit to the British Empire Exhibition at Wembley, and I am very enthusiastic about it. I should like to think that every Meccano boy who can possibly do so will visit this wonderful Exhibition. It is not merely a collection of interesting and curious things, but a representation in miniature of the British Empire. Thousands of Meccano boys may never have the opportunity of visiting our Overseas Dominions, and very few indeed will ever be able to see more than a small part of the Empire. Although the Wembley Exhibition cannot take the place of a tour of the Empire, it can, and does, give an accurate picture of everyday life and activities such as we can never get from books. The Exhibition is a great demonstration of the vastness of our Empire, and every boy who visits it will come away feeling prouder than ever that he is British. I am arranging a special Essay Competition for those who visit Wembley, and full particulars will be found on page 166.

A Great  
Exhibition

The section of the Exhibition in which I was most interested, and that which I feel sure will appeal most strongly to my

Triumphs of  
Engineering

readers, was the Palace of Engineering. Here, in a great hall, which has an area five times as large as Trafalgar Square, are displayed all manner of wonderful machines and inventions. One of the most interesting exhibits is the Constantinesco Torque Converter, recently described in the "M.M." I know that my readers will be interested to hear that the inventor of this wonderful device is using Meccano to demonstrate the principles of his Converter.

Size is no drawback to the exhibits in the Palace of Engineering. For instance, there is more than one full-size locomotive, a corridor coach, and other similar interesting exhibits. The original "Locomotion," the first passenger locomotive, is there, too, having been brought specially from Darlington for the Exhibition. It would require a whole "M.M." to describe fully the wonders of this great Exhibition, and its marvels must be seen to be appreciated, for no pen can do justice to the triumphs of British engineers there displayed.

And now just a word in regard to our next issue. We shall continue the story of Robert Stephenson, with an account of some of his bridge-building achievements and some details of the construction of the famous Britannia Tubular Bridge over the Menai Straits. Our article on Iron and Steel will deal with the wonderful processes employed in the manufacture of steel, which will also be the subject of a striking cover design. The wonders of Magnetism will be described in the Electricity article, and another new Meccano model will be illustrated. A special Railway article will deal with the story of railway carriages, and I also hope to publish an account of some very interesting experiments with the Meccano model of the Torque Converter, contributed by one of our readers. Radio will be represented by a description of Marconi's early experimental work, which led up to his great achievement—the conquest of the Atlantic. In addition to this very full programme there will be the usual Guild News and Club Notes, and Stamps, Competitions, Puzzles, and Fireside Fun.

Our Next  
Issue

IMPORTANT NOTICE.

We are constantly asked to supply back numbers of the "M.M." We print only sufficient copies to fill our regular orders, and back numbers cannot therefore be supplied. In order to prevent disappointment our readers are advised to place a regular order, with a Meccano dealer, a newsagent, or direct with us.



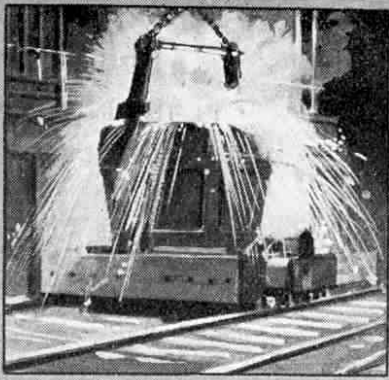

# The Story of Iron & Steel

## II. THE BLAST FURNACE. CAST AND MALLEABLE IRON

IN the early days of iron manufacture the ore and fuel were simply placed together in a rough furnace. Sufficient heat was applied to melt the iron out of the ore, and it collected at the bottom of the furnace. Gradually the process was improved, notably by the use of a forced draught and the employment of certain materials, such as limestone, as "fluxes" to unite with impurities in the ore. To-day all ore is smelted in what is called a blast furnace.

### A Typical Furnace

The accompanying diagram (Fig. 1) gives a good idea of the construction of a typical blast furnace. The circular shaft, shaped as shown, is lined with firebrick which will stand an enormous amount of heat. The top of the shaft is closed by a conical stopper called the "bell." This stopper may be lowered to allow a charge of iron ore, limestone or coke fuel to be shot into the furnace. The blast pipe (P) which runs round the hearth is also shown, together with two of the nozzles called "tuyères" (pronounced "tweyers") by which the blast is conveyed to the interior of the furnace. These tuyères have to withstand a terrific heat, and to prevent them from melting they are surrounded by pipes through which cold water constantly circulates, or water-jacketed as it is called. The diagram also shows the two openings (S) and (I) through which the slag and the molten iron respectively are drawn off. Finally, there is an opening near the top of the shaft to lead off the hot gases produced.

The earliest blast furnaces were open at the top, and were very conspicuous objects at night with their fierce flames flaring out and illuminating the surrounding country. After a while, however, it came to be realised that the gases escaping from the open top could be made use of, and about 1836 the close-topped furnace came into general use. The size of the furnace has gradually been increased, and a large modern furnace is about 100 ft. in height. These improvements have resulted in a corresponding increase in output. In 1800 a furnace produced little more than 20 tons of iron per week; to-day a Cleveland furnace can produce 1,300 or 1,400 tons per week.

### The Hot Blast

Iron manufacturers had endeavoured to get the furnace blast as cold as possible, on the assumption that the coldness of the air in winter was the cause of the best iron being produced during that season. In 1828, however, their ideas received a severe shock, for James Beaumont Neilson, a Scottish gas engineer, calmly proposed that the blast should be heated! Neilson was manager of the Glasgow gas works, and was consulted by an ironmaker with regard to a defect in a blast furnace. After a good deal of thought he hit upon the idea of heating the blast air, thus increasing its volume and enabling it to do more work in the furnace. At first his idea was ridiculed, and the ironmasters were very indignant at the impudence of a mere gas engineer in assuming to talk to them about ironmaking! But

Neilson proved to be right, and the hot blast not only resulted in a great saving of fuel, but also in increased output from the furnaces.

### Making Use of Waste Gases

At first the blast was heated by passing it through pipes heated by a special furnace, but now the gases produced in the smelting furnaces, instead of being allowed to escape into the air and be wasted, are passed into what are called "regenerative" stoves, invented by E. A. Cowper about 1860. These stoves, which are upright circular chambers from 60 to 100 ft. in height and from 20 to 26 ft. in diameter, are built of steel plates with a double inner wall of firebrick. The gas from the blast furnace is passed into the stove, mixed with air and burned, the hot gases thus produced heating a brickwork stack inside the stove and then passing away through a chimney. When the brickwork is hot enough the furnace gas and the air are shut off, and the cold air from the blowing engines is driven into the stove.

In passing through the stove the blast becomes heated to a temperature of from 1,100 degrees to 1,500 degrees Fahrenheit, and is then sent direct to the tuyères in the furnace hearth. When we remember that water boils at 212 degrees, we may form some idea of what a temperature of 1,500 degrees means. The blast continues to pass through the stove until the brickwork is cooled to a certain point, and then the blast is shut off and furnace gas and air are again admitted to re-heat the stove. In order to avoid any interruption in the heating of the blast three or four stoves are arranged in a group, and one heats the blast while the others are being heated by the combustion of the furnace gas.

In Great Britain the pressure at which the blast enters the furnace varies from about 4 lb. to 12 lb. per square inch. The blowing engines are usually driven by steam, but large gas engines are also used, and in some cases the blowing plant is electrically operated. Several furnaces may be blown from one big main, or each furnace may have its own blowing engine. The latter is the modern method, its great advantage lying in

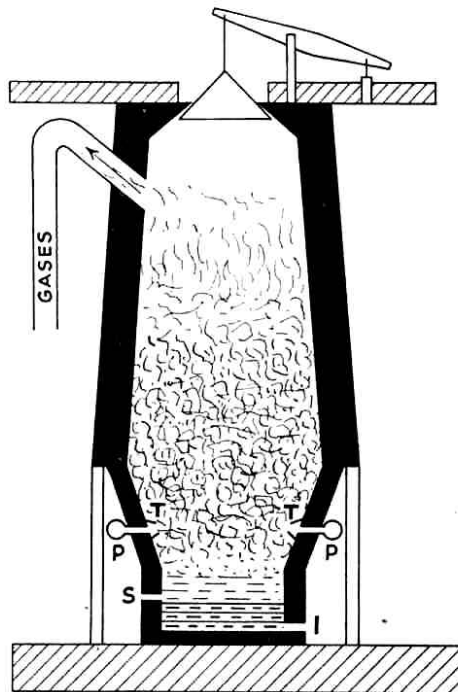

Fig. 1. Diagram of Blast Furnace

T = Tuyères  
I = Iron outlet  
S = Slag outlet  
P = Blast-pipe

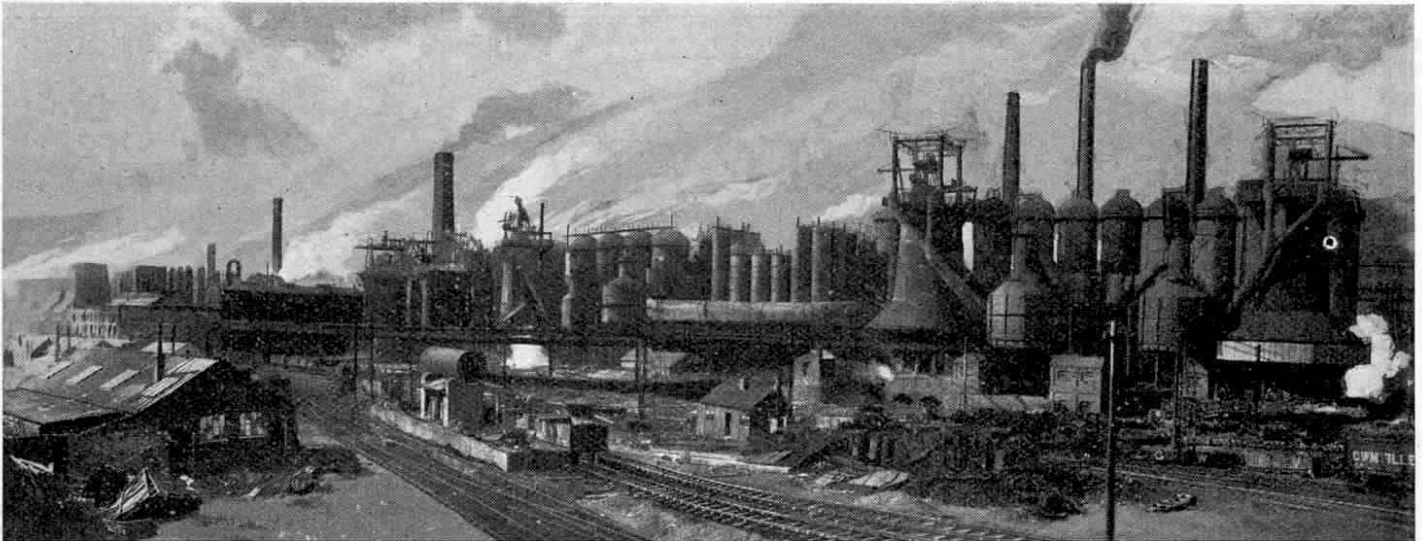

Photo courtesy of]

[Messrs. Ebbw Vale Steel and Iron Co. Ltd.

### Victoria Blast Furnaces, Ebbw Vale

the fact that it enables the blast pressure to be adjusted to suit the varying requirements of each furnace.

The gas produced in the furnaces is not all used up in heating the blast, but there is usually sufficient of it to be burned to raise steam for the engines, or, after purification, to be used in gas engines.

#### What Happens in the Furnace

Let us imagine that the furnace fire is started, that a charge of ore and limestone has been put in, and the blast turned on. The full heat is not reached at once but takes some days to develop. Furnaces are kept burning day and night for months, or even years, the fires being extinguished only when repairs to the furnaces become necessary. When a furnace is started it is said to be "blown in," and when it is stopped it is "blown out."

It is easy to understand that coke is used to heat the furnace, and that iron ore is necessary to produce the iron. But why is limestone added? We have already mentioned that its use is as a "flux." In the ore are certain materials that must be got rid of in order to obtain the iron, and a flux is something that mixes readily with these unwanted materials. The actual processes that take place while the furnace is in action are too complicated to describe in detail, but roughly speaking some of these materials are drawn off in the form of gases as already described, and others mix with the limestone and form a substance called "slag." The iron and the slag fall to the bottom of the furnace, and as the iron is heavier than the slag it drops to the lowest level. The slag rests upon the iron, only mixing with it to a very small extent, both being drawn off through separate openings.

The slag is taken from the furnace in a sort of huge ladle resting in a truck. It is carried to a convenient place and tipped out, forming the slag-heaps that are such a conspicuous feature near all iron-works. A good deal of the slag is utilised for making the foundation of roads, and for laying between the "sleepers" on which railway lines are carried, in the latter case being known as "ballast."

#### Pig Iron

We must now see what happens to the iron. When it is drawn from the furnace in a molten state it may be run into special vessels to undergo further treatment

(to be described later), or it may be run into what is called a "pig bed." This is a large bed of sand sloping gently away from the furnace. Depressions are made in the sand to act as moulds for the iron. Rows of these moulds cross the bed, and across the ends of the rows pass channels leading to the main channel from the furnace. Three or four times every 24 hours the iron is tapped by cutting away the plug of clay that closes the tapping hole. The molten metal then flows along the main channel into one of the secondary channels and so into the moulds. When all the moulds in that particular section are filled, the iron is diverted into another channel with its set of moulds, and so on.

The iron in the main channel is called a "runner," that in the secondary channel a "sow," and the moulds are called "pigs." When the metal has solidified, but is still hot, the pigs, which weigh rather more than a hundredweight

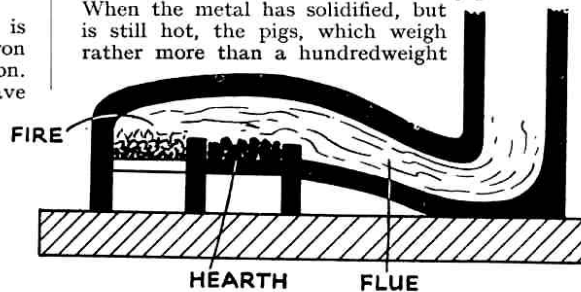

Fig. 2 Diagram of Reverberatory Furnace

each, are broken off the sows by means of heavy hammers, and the sows and runners are broken up into pieces of a convenient size to be handled.

#### Foundry Castings

The quality of the pig iron obtained in this manner varies considerably and is usually judged by breaking some of the pigs and noting the appearance of the fracture. Generally speaking, the best iron has large crystals and open grain, while inferior qualities have smaller crystals and closer grain.

If the pig iron is not intended for steel-making, it is used, according to its quality, either for making castings or for making into "wrought" or "malleable" iron.

The higher qualities of iron are used for making castings in the foundry. The pigs are broken into pieces and are re-melted in a furnace called a "cupola," which is really a small blast furnace, and

then run off into the required moulds. The best castings are made from a mixture of different qualities of iron, the choice of mixture being determined by the purpose for which the casting is intended. If a casting has to undergo a large amount of machining it is important that it should not be so hard as to cause excessive wear of the tools. On the other hand, if a casting is not to be machined, extreme hardness is of no importance.

#### Wrought or Malleable Iron

Wrought or malleable iron is made from the lower qualities of pig iron by a process known as "puddling." This is carried out in what is called a "reverberatory" furnace, introduced in 1784 by Henry Cort, a Lancaster man. Cort, while acting as a Navy agent, became impressed by the poor quality of British iron as compared with that from foreign countries, and he set about to try to improve the British product. The reverberatory furnace by which he achieved success, as modified by later experience, is shown in Fig. 2. It will be seen that in this furnace the iron and the fuel are not mixed together, but kept separate by a low wall. The flames, on their way to the flue, give up most of their heat to the roof of the furnace, and on account of the curved shape of the roof the heat is "reverberated" or reflected back on to the metal below. The floor of the hearth in which the iron is placed consists of an iron plate covered with "fettling," a substance such as hematite ore, containing oxide of iron. Some scrap iron is also put in, and when the hearth is heated to a high temperature pig iron, broken into small pieces, is introduced.

When the charge has melted, the impurities in the pig iron unite with the oxygen in the fettling, slag is produced, and the iron boils vigorously. A long iron bar, or "rabble" is inserted through a hole in the wall of the furnace, and the metal is thoroughly stirred in order that its impurities may be got rid of more easily. Finally the iron stiffens, and the puddler with his rabble rolls it into ball-like masses, which are then removed. The iron is immediately hammered under a powerful steam hammer, during which process the slag mixed with it is expelled. Finally the iron is rolled into bars.



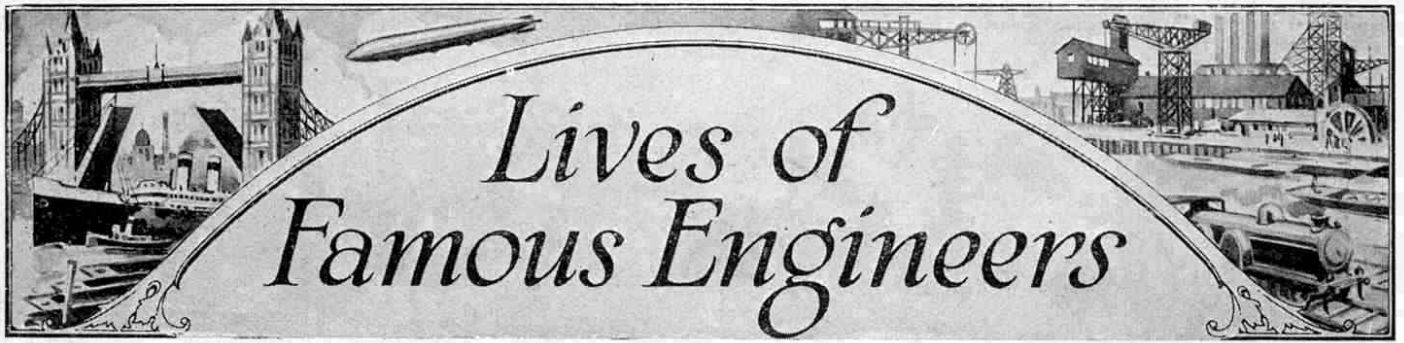

## V. ROBERT STEPHENSON: Builder of Railways and Bridges

**R**OBERT STEPHENSON was born on October 16, 1803, at Willington Quay, a village on the north bank of the Tyne, about six miles below Newcastle. At the time of his birth his father was employed as brakesman at the local colliery, but about two years later the family removed to Killingworth, where the first locomotive was subsequently erected.

In 1806 Robert's mother died, and his father, remembering his own difficulties through lack of education, determined that his son should have the best education he could possibly provide for him. By a great effort he managed to send the boy to a school at Newcastle, and in the evenings father and son worked together on mechanical problems. It was in this manner that Robert learned to read a drawing of a machine as readily as he could read a page of a book.

### A Shock for the Pony

Robert was as full of high spirits as any other boy, and was always ready for some fun. On one occasion, after reading the story of Benjamin Franklin's lightning experiment with a kite,\* he determined to try this for himself. He expended his small savings on the purchase of about half-a-mile of copper wire, which he attached to a large kite. The lower end of the wire was insulated by a few feet of silk cord. When his kite was flying well, he brought the end of the wire just over the back of his father's pony, which was tied to a railing waiting for its master to come out of the cottage. The result was that the pony received a shock so severe that it was nearly knocked over! George Stephenson came out of the cottage in time to see this performance, and though he called Robert a mischievous scoundrel, he was secretly delighted at the success of the experiment.

### Robert Goes to Edinburgh

Robert left school in 1819, and became an apprentice at the Killingworth Colliery. The experience he gained there was very valuable to him, but his father was anxious that he should have a proper training in technical science. Consequently, Robert left the Colliery in 1822 and went to Edinburgh University, where he studied very hard for six months, giving special attention to Chemistry and Geology.

On his return to Killingworth he had acquired what was in those days a good

\* Described in last month's "M.M." (p. 133).

technical education and this was backed by practical experience at the Colliery. He gained further valuable engineering knowledge by assisting his father in the preliminary survey for the Stockton and Darlington Railway, and by then felt ready to launch out for himself.

### Mining in South America

An opportunity occurred for him to go to South America to take charge of the engineering operations of the Colombian Mining Association. He decided to accept

In our concluding article on the work of George Stephenson, contained in last month's issue, we referred briefly to his only son, Robert. The life of Robert Stephenson was very eventful, and the story of the great engineering works he carried out is full of interest.

the offer, and sailed for South America in 1824. After landing at La Guayra, Venezuela, he began a remarkable journey of over 1,200 miles, entirely on mule-back. This journey made a great impression upon him, and in later years he used to speak in enthusiastic terms of the wonders of mountain and valley that were revealed to him. Finally he reached Bogota, and after an interview with the commercial manager of the mining company, he went on to the site of his intended labours on the eastern slopes of the Andes.

### Opening-up an Ancient Mine

After a long and careful survey of the region, he decided to commence operations at an ancient mine that had been worked in bygone days by the Spaniards. The old workings were completely overgrown and lost, and everything had to be begun over again. The task of cutting roads and opening-up the mine was not to the liking of the native labourers, and Stephenson had a great deal of trouble with them. If they were not watched continually they deserted in large numbers. A party of Cornish miners were on the way out from England, and Stephenson hoped that on their arrival matters would improve, but they turned out to be even more troublesome than the natives. They were a quarrelsome, drunken lot, and at times quite unmanageable.

Stephenson stuck to his task, however, and by great efforts contrived to keep the work going. The harassing nature of his position was so aggravated by hostile criticism of his reports to the Board of the Company at home, and by attacks of fever that made him very

weak, that he determined to leave at the end of his engagement, which was for three years. As soon as his decision reached London great efforts were made to induce him to remain, but another attack of fever, together with the fact that his father wanted his assistance, strengthened his decision to return home.

### A Strange Meeting

In 1827 Stephenson left for the port of Cartagena, intending to proceed at once to New York, but he had to wait a long time for a ship. The delay worried him very much, especially as yellow fever had ravaged the town. While sitting one day in the public room of the hotel at which he was staying, he noticed two men whom he saw at once were English. One of them was a tall thin man, very shabbily dressed, and apparently in poverty. On inquiry Stephenson was astonished to learn that his was Trevithick, the builder of the first railway locomotive.

Trevithick had left England in 1816, taking with him steam engines for draining and working mines in Peru. He was received with the wildest enthusiasm on his arrival at Lima, and it was actually proposed to erect a statue of him in solid silver! Afterwards, however, everything went wrong with his schemes, and he learned the bitter truth of the Spanish proverb: "A silver mine brings misery, a gold mine ruin!" Trevithick and his friend had lost everything during their journey across country from Peru. They had forded rivers and wandered through forests, finally arriving at Cartagena practically penniless. Stephenson lent Trevithick £50 to enable him to reach England, and eventually he arrived safely at his home in Cornwall.

### A Stormy Voyage

At last a ship arrived at Cartagena and Stephenson set sail, but he had to pass through a terrible experience before he reached New York. He gave a graphic account of his voyage in a letter to a friend:—"At first we had very little foul weather, and indeed were for several days becalmed amongst the islands, which was so far fortunate, for a few degrees further north the most tremendous gales were blowing, and they appear—from our future information—to have wrecked every vessel exposed to their violence. We had two examples of the effects of the hurricane, for, as we sailed

north, we took on board the remains of two crews found floating on dismantled hulls. The one had been nine days without food of any kind, except the carcasses of two of their companions who had died a day or two previously from fatigue and hunger. The other crew had been driven about for six days, and were not so dejected, but reduced to such a weak state that they were obliged to be drawn on board our vessel by ropes. A brig bound for Havannah took part of the men, and we took the remainder.

"To attempt any description of my feelings on witnessing such scenes would be in vain. You will not be surprised to learn that I felt somewhat uneasy at the thought that we were so far from England, and that I also might possibly suffer similar shipwreck, but I consoled myself with the hope that fate would be more kind to us. It was not so much so, however, as I had flattered myself; for on voyaging towards New York, after we had made the land, we ran aground about midnight. The vessel soon filled with water, and, being surrounded by the breaking surf, the ship was soon split up, and before morning our position became perilous. Masts and all were cut away to prevent the hull rocking, but all we could do was of no avail. About eight o'clock on the following morning, after a most miserable night, we were taken off the wreck, and were so fortunate as to reach the shore."

#### Stephenson Returns to England

Stephenson was none the worse for his trying experience, and after a short tour in the United States and Canada he took ship for England and arrived safely at Liverpool. By this time the Liverpool and Manchester Railway was nearing completion, and the heated controversy had begun as to how the trains should be drawn. The ultimate triumph of the "Rocket," with the resulting decision of the promoters to employ locomotives, was described in the article on George Stephenson in our last month's issue.

While the works of the Liverpool and Manchester Railway were proceeding, George Stephenson was asked to undertake the construction of a short line of about 16 miles in Leicestershire, to open up communication between Leicester and the colliery districts in the western part of the county. As he had already 30 miles of railway in hand, he felt that he could not undertake any further work, but he recommended his son for the post. Robert was appointed, and towards the end of 1830 commenced the construction of the line. The engineering difficulties, with the exception of one

tunnel, were comparatively slight, and the work was successfully carried out.

#### Constructs the London—Birmingham Railway

Robert Stephenson now came into prominence in connection with a much bigger undertaking—the construction of



Robert Stephenson

a railway between London and Birmingham. George Stephenson was consulted as to the route, and was then appointed engineer of the line in conjunction with his son. This project met with even stronger opposition than the Liverpool and Manchester line. Canal proprietors, landowners and road trustees combined to fight against it, and a bitter struggle followed. Pamphlets were published warning the public to beware of the scheme, and the promoters were held up to ridicule as being only fit for a madhouse. Public meetings were held in every county through which the line would pass, and strong resolutions against it were carried unanimously.

The opposition of the landowners was so strong that it was extremely difficult to make the survey, and at some points the work had to be done secretly at night by the aid of lanterns. Robert Stephenson stuck to the work with the dogged perseverance he had inherited from his father, and in his anxiety to make sure of selecting the best line he walked the whole distance between London and Birmingham more than twenty times!

The Bill for the railway came before Parliament in 1832, and passed through the House of Commons but was thrown out by the House of Lords. Nothing daunted, the promoters presented another Bill in the next session, and this time it passed both Houses almost without opposition. The explanation of this sudden change appeared later, when it became known that the promoters had agreed to pay landowners about £750,000 for land originally estimated at £250,000! The preliminary difficulties having been surmounted, no time was lost in commencing operations. Robert Stephenson, with the consent of his father, was now appointed sole engineer, and by the beginning of 1840 work was in satisfactory progress.

#### Difficulties of Construction

The length of the line to be constructed was about 112 miles, and the engineering difficulties proved to be very great. Huge excavations had to be made in order to construct a level road from valley to valley. Among these was the Tring cutting, which is 2½ miles in length, and for a quarter of a mile is 75 ft. in depth. Another great work was the Blisworth cutting, which is 1½ miles in length and in places 65 ft. in depth, passing through stiff clay and hard rock. A million cubic yards of material were dug, quarried or blasted out of this cutting, and 800 men and boys were employed on the work.

Eight tunnels were constructed on this line, their total length being 7,336 yards. The chief difficulty was encountered in the tunnel under Kilsby Ridge, a few miles from the scene of the battle of

Naseby. During the excavation it was unexpectedly found that an extensive bed of quicksand existed under a bed of clay 40 ft. in thickness, lying between two trial shafts that had been sunk. Work was proceeding at the bottom of one of these shafts when the roof suddenly gave way. A deluge of water burst in, and the workmen were only saved from death by means of a raft, on which they were towed by one of

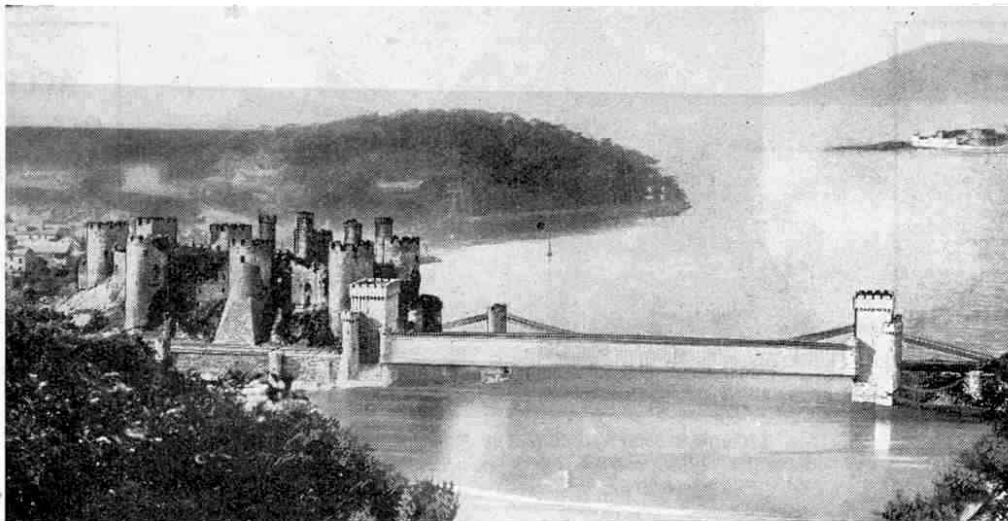

Robert Stephenson's Tubular Bridge at Conway

Illustration shows Conway Castle and the Tubular Bridge. Beyond are the towers and supporting chains of the Suspension Bridge

(Cont. on page 165)

BUILD YOUR OUTFIT INTO A No. 6

WITH

# MECCANO

## ACCESSORY OUTFITS

For convenience, Meccano parts are sold in nine Outfits of varying size, numbered 00 to 7. The quality and finish of the parts are of the same high standard throughout the series, but as the Outfits increase in size they contain larger quantities and greater varieties of parts. Each Outfit may be converted into the one next higher by the purchase of an Accessory Outfit. Thus, if a No. 2 is the first Outfit bought, it may be converted into a No. 3 by adding to it a No. 2a. A No. 3a would then convert it into a No. 4, and so on up to No. 7. In this way, no matter with what Outfit you commence, you may build up by degrees to a No. 7 and so be able to make *all* the many hundreds of models shown in the Books of Instructions.

### PRICE LIST

#### Complete Outfits

No. 00	.. ..	3/6
No. 0	.. ..	5/-
No. 1	.. ..	8/6
No. 2	.. ..	15/-
No. 3	.. ..	22/6
No. 4	.. ..	40/-
No. 5 (In well-made carton)		55/-
No. 5 (In superior oak cabinet with lock & key)		85/-
No. 6 (In well-made carton)		105/-
No. 6 (In superior oak cabinet with lock & key)		140/-
No. 7 (In superior oak cabinet with lock & key)		370/-



*No. 5 Outfit. This Outfit builds 309 splendid working models. A No. 5a Outfit, costing (carton) 50/- or (wood) 80/-, converts this Outfit into a No. 6, with which 360 models may be built.*

### PRICE LIST

#### Accessory Outfits

No. 00a .. ..	1/6
No. 0a .. ..	4/-
No. 1a .. ..	7/6
No. 2a .. ..	8/6
No. 3a .. ..	18/6
No. 4a .. ..	15/-
No. 5a (carton) ..	50/-
No. 5a (wood) ..	80/-
No. 6a .. ..	210/-

BUILD  
BIGGER  
AND  
BETTER  
MODELS



*No. 6 Outfit. This Outfit builds 360 splendid working models. A No. 6a Outfit, costing 210/- in splendid oak cabinet, converts this Outfit into a No. 7, with which any Meccano model may be built.*

ACCESSORY  
OUTFITS ARE  
OBTAINABLE  
FROM ANY  
MECCANO  
DEALER

MECCANO LTD.

Binns Road

LIVERPOOL



# A NEW MECCANO MODEL

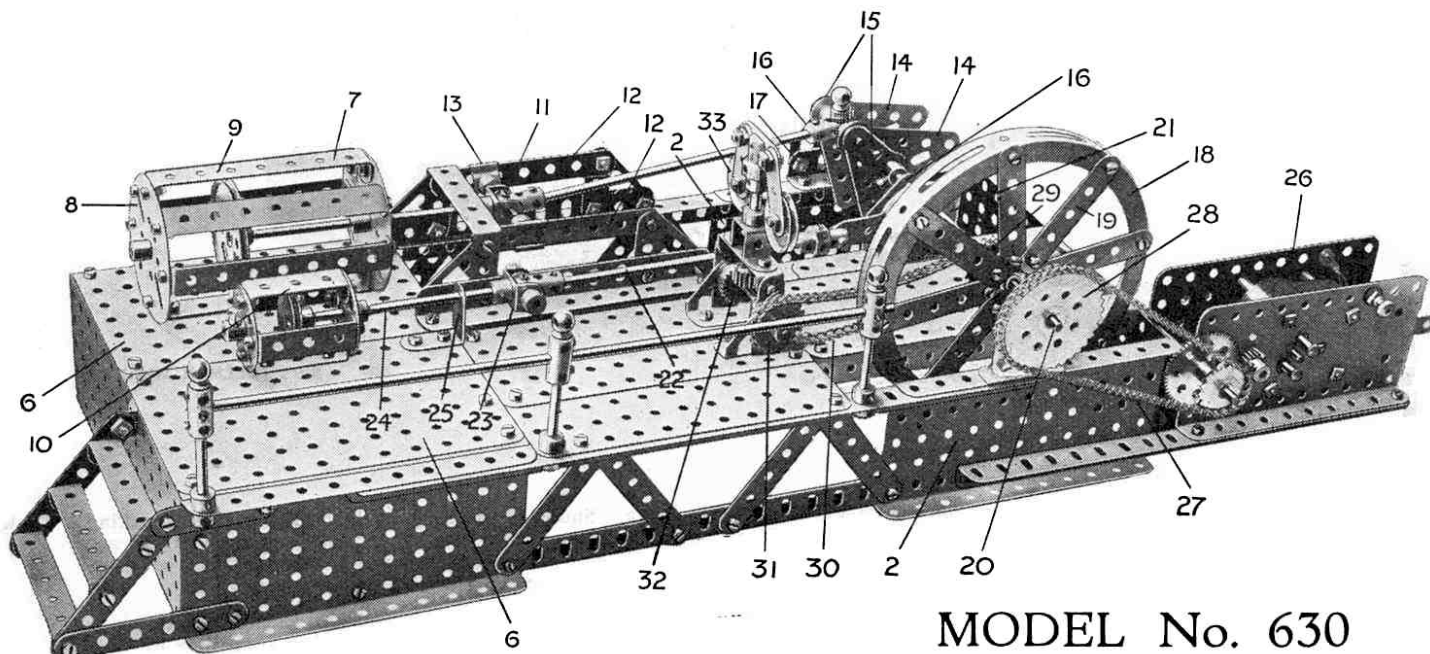

MODEL No. 630

## Horizontal Steam Engine

**T**HIS month we have chosen as the subject of our new model a horizontal steam engine of the single-cylinder type, such as may be seen driving machinery in mills or factories. In this engine steam is admitted to the cylinder first at the front of the piston and then at the back. The piston is thus pushed alternately backwards and forwards, and from this movement such engines are called "reciprocating." The type of reciprocating engine illustrated is one of the simplest, and yet in spite of its simplicity the combined efforts of many inventors were necessary to produce it.

It is interesting to go back to the early days of the steam engine and see how it has developed, step by step, from a mechanical curiosity to a perfect working apparatus.

### First Practical Steam Engine

James Watt is commonly regarded as the inventor of the steam engine, but as a matter of fact a number of engines using steam had been produced before his time. Watt's great work lay in bringing the steam engine to a state of practical perfection.

The idea of using steam in a cylinder appears to have originated with Denis Papin, a Frenchman, and about the year 1688 he constructed a working model to illustrate his idea. The first really practical engine was constructed in 1710 by Thomas Newcomen, an Englishman, and it was used as a pumping engine. It consisted of a vertical steam cylinder, the piston of which was connected to one end of a beam pivoted in the middle.

The other end of the beam was attached to rods working the pump. Around the cylinder was a jacket, to which cold water could be supplied.

When the piston in the working cylinder was at the top of its stroke, being raised by the weight of the pump rods, steam was admitted to the cylinder so as to drive out all the air. The steam was then shut off and cold water was admitted to the outer jacket. This condensed the steam in the working cylinder so that a partial vacuum was produced, and atmospheric pressure forced the piston down, thereby raising the pump rods. Each time this occurred one stroke of the pump was made and the operation was then repeated. Newcomen's engine, improved later in some details by its inventor, was used extensively in pumping water from mines. It will be seen that the engine was not a true steam engine, for the forcing down of the piston was done by atmospheric pressure.

### James Watt's Great Idea

A model of the Newcomen engine came into the hands of James Watt for repair, and while engaged on this task he hit upon the idea on which the modern steam engine is based.

In the Newcomen engine the working cylinder was first heated by steam and then cooled by water to condense the steam. Watt saw that this alternate heating and cooling resulted in a great waste of energy, and endeavoured to find some means of keeping the cylinder at an even temperature. It took him a long time to solve the problem, but at last he succeeded by condensing the

steam in a separate vessel, instead of in the working cylinder itself.

### Talkative Workman Causes Trouble

Watt's improved engine, patented in 1769, was used entirely for pumping, as Newcomen's had been. In 1781 Watt took out another patent for an engine in which the reciprocating motion of the piston was converted into rotary motion, so that ordinary machinery could be driven. Watt had intended to obtain this rotary motion by means of the now familiar crank and flywheel, but he found himself prevented from doing so because a Birmingham button-maker named James Pickard had succeeded in obtaining a patent for this device a few months previously. Pickard apparently got the idea from one of Watt's workmen, who had been talking too freely and bragging about the great things that the rotary engine was going to accomplish.

Watt was very angry when he found what had happened, and for a while he was puzzled to overcome the difficulty thus created. He determined not to be beaten, however, and after trying various schemes he decided to use a device invented by his best workman, William Murdoch. This device was called the "sun-and-planet" motion, and was utilised on Watt's rotary engines until Pickard's patent expired, after which the simpler and more efficient crank and flywheel were substituted.

### Watt's Final Improvements

Up to this time Watt's engines were "single acting"—that is to say the

FOR YOUR NEXT BIRTHDAY PRESENT CHOOSE

# HORNBY CLOCK WORK TRAINS

The Trains with the Guarantee

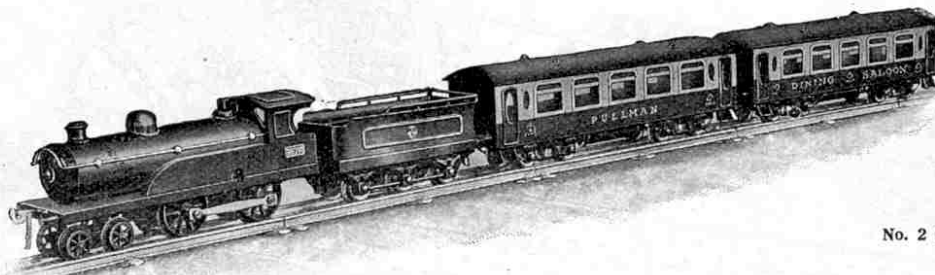

No. 2 PULLMAN TRAIN

You have no idea how much fun you can have with a Hornby Train. Shunting, coupling-up the rolling stock and making up trains to dash around their track as realistically as the real thing, will give you hours of pleasure. Hornby Trains are beautifully finished, strongly made, and will last for ever. One of their most remarkable features is that they may be taken to pieces and rebuilt. All the parts are standardised and any lost or damaged part may be replaced with a new one.

There are over 40 train accessories—stations, signals, lamps, a variety of wagons, level-crossings, turntables, etc., each of which is built in correct proportion and beautifully finished. New accessories are added to the system from time to time. Ask your dealer to show you the latest specimens or send to Meccano Ltd., Binns Road, Liverpool, for a full price list which will be sent (post free) on application.

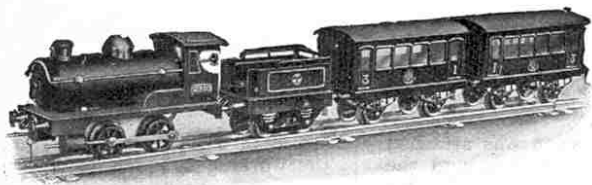

No. 1 PASSENGER TRAIN



No. 1 GOODS TRAIN

## HORNBY TRAIN PRICES

No. 1			
Goods Set	...	25/6	Wagons ... .. each 3/9
Passenger Set	...	35/-	Tenders ... .. " 3/6
Locos	...	each 16/-	Passenger Coaches .. 6/6

No. 2			
Goods Set	...	45/-	Wagons ... .. each 3/9
No. 2 Pullman Set	...	70/-	Tenders ... .. " 4/-
Locos	...	each 30/-	Pullman Cars ... .. " 16/-

## HORNBY TANK LOCOS

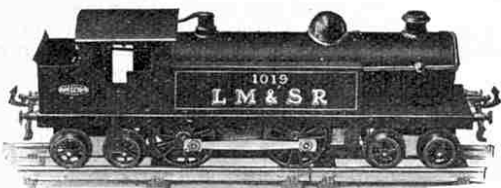

No. 2

The Hornby No. 2 Tank Loco is a powerful model embodying all the characteristics of the Hornby Train. It is 11½" in length and is fitted at both ends with a special bogey. Beautifully finished in colours; lettered L.M.S. and L.N.E.R., with reversing gear, brake and governor. Suitable for 2 ft. radius rails only.

Price ... .. 32/6

### Guarantee

Hornby and Zulu Trains are tested, and their efficiency is guaranteed. A form of guarantee is furnished with each loco, and we undertake to repair, or replace at our option any loco that fails to run satisfactorily from any cause other than misuse, within 60 days of purchase.

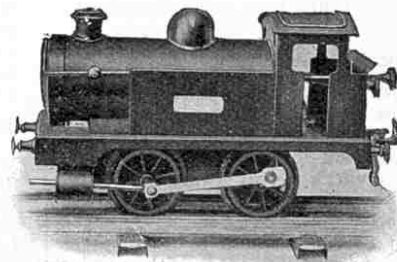

No. 1

The Hornby Tank Loco No. 1 is a strong and durable loco capable of any amount of hard work; richly enamelled and highly finished; fitted with reversing gear, brake and governor.

Gauge 0, in black only ... .. 12/6

FROM ALL MECCANO DEALERS



**A New Meccano Model (cont. from page 151)**

cylinder was connected to the condenser only on one side of the piston, so that work was only performed during one stroke of the piston. In 1782 Watt took out a patent for connecting the cylinder to the condenser both back and front of the piston, thus making the engine "double acting," and consequently much more efficient.

In the same year he obtained another patent for a method of securing greater economy in the use of steam. The principle involved in this final improvement was that of shutting off steam from the cylinder when the piston had only travelled part of its journey, and leaving the rest of the thrust to be carried out by the expansion of the steam.

The brilliant inventions we have briefly described were Watt's chief contributions towards the perfecting of the steam engine. Watt found the steam engine a clumsy mechanism, very inefficient and wasteful of fuel, and only capable of working a pump. Through his inventions it became efficient and economical, and capable of working machinery of almost every kind.

**Constructing the Model**

This fine new model of a Horizontal Steam Engine may be made with a No. 6 Outfit, and its construction presents no difficulty. Begin by building the platform, an underneath view of which is shown in Fig. A.

Three 12½" girders (1) are bolted to rectangular plates (2) at each end of the frame, other 12½" girders (3) being bolted to the remaining flanges of the girders. The ends of the bed frame are formed by small rectangular plates (4), and 3" strips (5) brace the inner part of the frame.

As shown in the illustration on page 151, a portion of the top of the bed frame is enclosed by flat plates (6), and on these is bolted the cylinder (7) formed of face plates (8) connected by 3½" double angle strips (9). The valve-casing (10) is formed of bush wheels connected by 1½" double angle strips and is also bolted to the bed frame.

The cross-head (11), the construction of which will be followed from the illustration, is guided on the strips (12) by eye pieces

(13) at each side. The crank is made up of triangular plates (14) representing the balance weights, secured to cranks (15). The main or crank shaft (20) is journalled

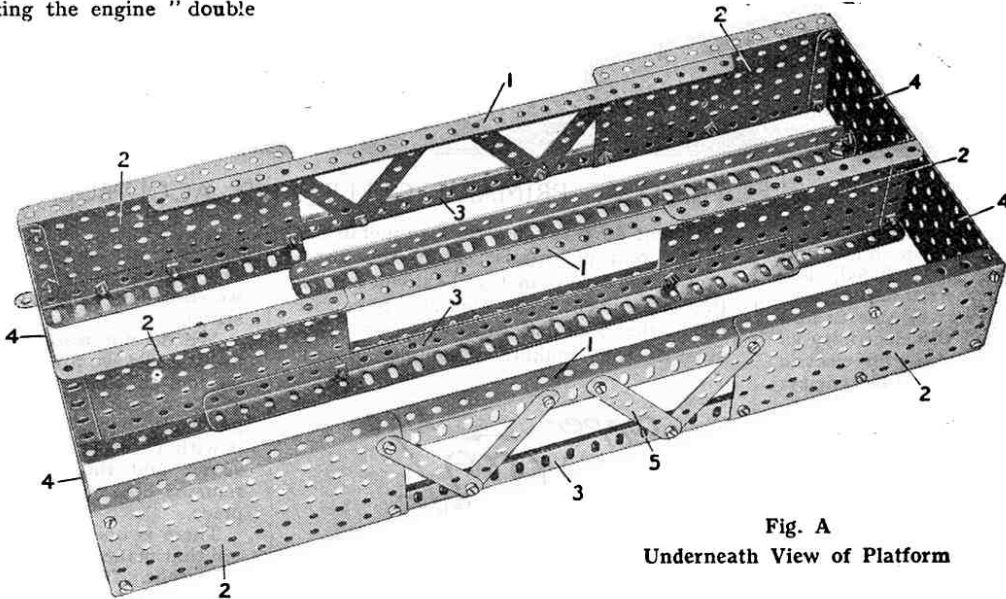

Fig. A  
Underneath View of Platform

in flat trunnions (16) secured to 1½" girders (17), which are in turn bolted to the flanges of the rectangular plates (2).

**Driving Details**

The fly-wheel is made of a large wheel flange (18) connected by strips (19) to a bush wheel secured to the shaft (20). The eccentric (21) is pivotally connected by a rod (22) to the fork piece (23) on the valve rod (24), which slides in the 1" angle bracket (25). The motor (26) drives by sprocket chain (27) a 2" gear wheel (28) on the shaft (20). A 1" sprocket wheel (29) drives, by sprocket chain (30), another 1" sprocket wheel (31) in the governor.

A contrate wheel (32) on the rod of the sprocket wheel (31) drives a ½" pinion on

the vertical rotating rod of the governor, the weights of which are formed by two pulley wheels (33) pivotally hung by 1½" strips, lock-nutted in the outer holes of a horizontal 1½" strip. This strip is bolted in the slot of an octagonal coupling secured to the top of the vertical rod of the governor.

In the operation of an engine such as the model represents, the valve (10) controls the admission of steam to each end of the cylinders (7), thus causing the crank shaft (20) to be driven. When the engine speed increases too much, the weights (33) of the governor fly out and shut off steam,

causing the engine to slow down again. The governor thus keeps the engine speed constant.

**Interesting Paragraphs**

**Duct Keels for Liners**

It is reported that two Orient liners are to be fitted with duct keels. The chief advantage of this system is the fact that the water-tight bulkheads have not to be pierced for piping, and the ship is therefore more seaworthy should any collision occur.

\* \* \* \*

**A Powerful Overhead Travelling Crane**

An overhead travelling crane recently installed in the River Rouge repair shop of the Detroit, Toledo and Ironton Railway at Detroit, Mich., lifts a locomotive weighing 100 tons and turns it end for end in one minute. The grab has two sets of falls spaced 7 ft. apart, and is mounted on a turntable.

\* \* \* \*

**Hydraulic Tunnel at Niagara**

The new hydraulic pressure tunnel of the Niagara Falls Power Company, which has cost some £500,000 to construct, was recently opened for public inspection. This tunnel, which is 4,300 ft. in length and has a diameter of 32 ft. with a 2 ft. thick concrete lining, runs from an intake on the upper river, half a mile above the Falls, to another intake on the banks of the lower Gorge. The tunnel carries a volume of water sufficient to operate three hydro-electric power units, each of 70,000 horse-power capacity, in the powerhouse addition below the Gorge bank.

Parts required for Construction of Meccano Model 630 Horizontal Steam Engine			
2 of No. 3	1 of No. 13	1 of No. 29	2 of No. 63b
11 " " 4	2 " " 14	160 " " 37	3 " " 70
8 " " 5	1 " " 15	20 " " 38	2 " " 76
1 " " 6	1 " " 15a	1 " " 45	26 " " 94
5 " " 6a	2 " " 16	4 " " 48	1 " " 95
7 " " 8	2 " " 16a	4 " " 48a	3 " " 96
1 " " 8a	5 " " 17	6 " " 48b	2 " " 109
3 " " 9	2 " " 18a	2 " " 50	2 " " 116
1 " " 9d	1 " " 20a	7 " " 52	1 " " 118
3 " " 9f	1 " " 22	2 " " 52a	2 " " 126
4 " " 10	2 " " 22a	4 " " 53	3 " " 126a
2 " " 11	3 " " 24	16 " " 59	4 " " 133
2 " " 12	3 " " 26	4 " " 62	3 " " 136
1 " " 12a	2 " " 27a	6 " " 63	1 4-volt Elec. Motor

**The Meccano Clock**

Full instructions for building the Meccano Clock are now available in the form of a beautifully-printed leaflet, with numerous illustrations. This will be sent, post free, to any address, price 4d. Similar leaflets dealing with the Meccano Chassis and Loom are also in stock, price 4d. each, post free. If ordered at the same time a copy of each leaflet will be sent, post free, price 10d. the three.

# ELECTRICITY

*A series of Splendid Articles  
specially written for Meccano Boys*

## IV. CURRENT ELECTRICITY: PRIMARY CELLS AND ACCUMULATORS

In our previous article we saw that if a metal rod is held in the hand and rubbed, electricity is produced, but it spreads at once over the rod and escapes through the hand. If we are able to find some means of renewing the electricity as fast as it escapes, we obtain an electric current, or a continuous flow of electricity.

### Voltaic Cells

Fig. 17 is a diagram of a Voltaic Cell, from the name of its originator, Volta, whom we have already mentioned. The cell consists of a glass jar containing water to which has been added a little sulphuric acid. Two metal strips, one of zinc and the other of copper, are placed in the jar as shown at Z and C. If the two strips are connected by a piece of wire, an electric current flows in the direction indicated by the arrows. The current is produced by a difference of "electrical potential" between the zinc and the copper.

### Electrical Pressure

To understand the meaning of electrical potential we may make use of a simple illustration with water. If we pour water into a vessel, a certain amount of water pressure is produced. This could be made to do work by allowing the water to flow out through a small opening in the vessel on to a model water wheel. The amount of pressure available depends upon the height of the water, and this again depends upon the quantity of water and the capacity of the vessel, for it is clear that a certain quantity of water will reach a greater height in a small vessel than in a larger one.

A certain quantity of electricity in a conductor produces a certain electric pressure, the amount of this pressure depending upon the quantity of electricity and the electrical capacity of the conductor, for, as in the case of water vessels, conductors vary in capacity. This electrical pressure is called "potential." Water always tends to flow from a high level to a lower level, and in the same way electricity tends to flow from a conductor of high potential to one of lower potential.

The whole subject of electrical potential is complicated, but to put the matter in the simplest way, we regard a positively electrified body as being at a relatively high potential, and a negatively electrified body as being at a relatively low potential. We assume, therefore, that an electric current flows from a positive conductor to a negative conductor.

When we connect by a wire the two strips of metal in a voltaic cell,

a current flows because the two metals are at different potentials. From the direction of the arrows in Fig. 17 it will be seen that the current flows from zinc to copper inside the cell, and from copper to zinc outside, thus making a complete round

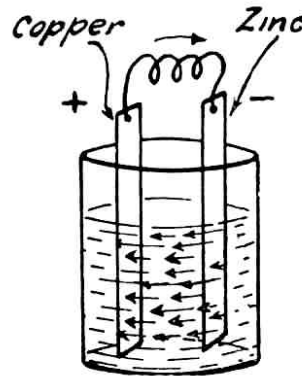

Fig. 17. Voltaic Cell

called a "circuit." If we break the circuit by disconnecting the wire, the current ceases to flow. The copper strip where the current leaves the cell is called

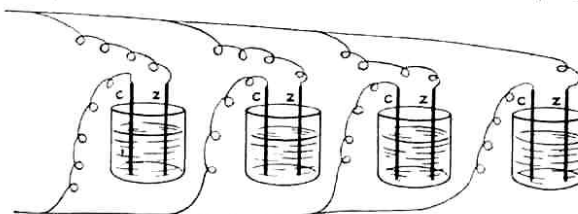

Fig. 18. Connecting in Parallel

the positive pole, and the zinc strip the negative pole.

### Chemical Action

The difference of potential between the two strips is maintained by chemical action between the zinc and the acid, resulting in weakening the acid and eating

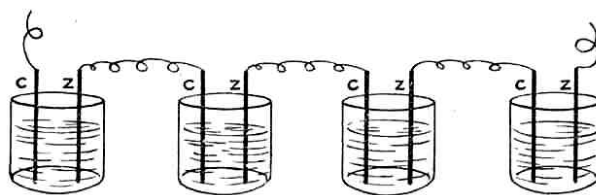

Fig. 19. Connecting in Series

away the zinc. The current continues to flow as long as this chemical action goes on. When we wish to stop the current, we disconnect the wire joining the metal strips.

We do not want the zinc to be eaten away while we are not using the cell, but we find that chemical action still goes on. We can stop this, however, by "amalgamating" the zinc, that is, by covering it with a thin coating of mercury or quicksilver, and then as long as the circuit remains broken, no chemical action takes place.

There is one great defect in the voltaic cell that makes it almost useless as a source of current. This defect is that the current it produces does not remain at full strength, but soon begins to weaken rapidly. This weakening is caused by bubbles of hydrogen gas which gather on the surface of the copper strip during the chemical action. These bubbles soon form a film on the copper, and they weaken the current partly by offering increased resistance to its flow, and partly by trying to set up another current in the opposite direction. A cell in this condition is said to be "polarized."

### Types of Cells

Many cells have been devised to reduce or prevent polarization. One of the most effective of these is the "Daniell" cell. This consists of an outer vessel of glass containing a circular copper plate. Inside this plate stands a round pot of unglazed porous ware, in which is a rod of amalgamated zinc. The outer vessel is filled with a very strong solution of copper sulphate, and the porous pot with dilute sulphuric acid.

When the circuit is closed and the current flows, the hydrogen set free by the action of the zinc on the acid passes through the porous pot into the outer vessel. Here another chemical action takes place, resulting in the splitting up of the copper sulphate solution into copper and sulphuric acid. There is now no free hydrogen to cause polarization, and instead of gas, pure copper is deposited on the copper plate.

Much more familiar than the Daniell is the Leclanché cell, used for ringing electric bells. In this cell carbon is used in place of copper. In the outer glass jar is a zinc rod immersed in a solution of sal-ammoniac. The inner porous pot contains a carbon plate surrounded by a mixture of crushed carbon and manganese dioxide. Hydrogen is liberated by the chemical action in the outer jar, but before it can reach the carbon plate and cause



polarization, the oxygen in the manganese dioxide combines with it. If the cell is used to give current continuously for several minutes, the hydrogen is produced faster than the manganese dioxide can deal with it, and the cell becomes polarized, but recovers completely after a short rest.

The so-called "dry" cells are the most popular of all to-day. They are not really dry, if they were there would be no current. They are simply Leclanché cells in which the liquid is absorbed into a moist paste. For convenience, the outer vessel is made of zinc, to serve instead of the zinc rod, and there is no porous pot, the space between the zinc vessel and the carbon plate in the middle being filled with the paste. The cells are sealed at the top, and are placed inside closely-fitting cardboard tubes. The great advantage of dry cells is the ease with which they can be carried about and placed in any position. Millions of tiny dry cells are used in pocket flash lamps.

#### How a Current is Measured

We must now learn something about the manner in which an electric current is measured. We know that water flows from the reservoir to our houses on account of a difference of level, which produces a water-moving or water-motive force. In a similar manner a difference of electric potential, such as exists between the plates of a voltaic cell, produces an electricity-moving or electro-motive force, which is measured in "volts." The rate of flow of water in a pipe is stated in gallons per second, and the rate of flow of an electric current is stated in "amperes." To put the matter briefly, volts represent the electric pressure at which a current is produced, while the current itself is measured in amperes.

Water flowing through a pipe is resisted by friction against the walls of the pipe. In the same manner, an electric current meets with resistance, although of a different nature. The amount of this resistance is small in a good conductor, but very great in a bad conductor. It is also greater in a thin wire than in a thick one, and greater in a long wire than in a short one.

Resistance is measured in "ohms."

The resistance of a circuit must be overcome by the electro-motive force before a current is able to flow, and the definition of a volt is that electro-motive force which will cause a current of one ampere to flow through a conductor having a resistance of one ohm. These three units of measurement are named respectively after the three famous scientists, Alessandro Volta, André Marie Ampère and Georg Simon Ohm.

#### Batteries of Cells

A single voltaic cell gives us an electro-motive force of from one to two volts, according to its type. A Leclanché cell, and a dry cell for instance, give about  $1\frac{1}{2}$  volts, and a Daniell cell about one volt.

Many people speak of a single voltaic cell as a

"battery." This is quite wrong, for a battery consists of a number of cells coupled together. Different methods of coupling produce different results. If we connect all the positive poles and all the negative poles of several Daniell cells—that is, copper to copper and zinc to zinc—we get a much larger current, but no more electro-motive force than from one cell. That is to say, we get more amperes but no more volts. This arrangement, shown in Fig. 18, is called connecting in "parallel." If we connect the positive pole of one cell to the negative

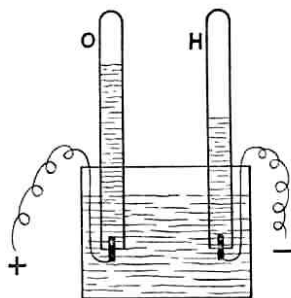

Fig. 20

pole of the next—or copper to zinc throughout—we add together the electro-motive forces of all the cells, but the amount of current is no greater than that of one cell. In other words, we get more volts, but no more amperes. This method is called connecting in "series," and is shown in Fig. 19. It is also possible to increase both volts and amperes by means of a combination of the two methods.

#### Accumulators

The cells we have already described are called "primary" cells and are quite different from "secondary" cells, or accumulators. Accumulators act as storage tanks, from which we may draw a supply of current whenever we want it, and which will give a much heavier current than any primary cell.

If we pass a current through water to which has been added a little sulphuric acid to increase its conducting power, the water is split up into the two gases of which it is composed—hydrogen and

oxygen. An apparatus for demonstrating this (shown in Fig. 20) consists of a glass vessel having two strips of platinum, called "electrodes," which are connected to a battery of Daniell cells (not shown). Two tubes, closed at one end, are filled with the acidulated water and inverted over the platinum strips. When the current flows, the water is decomposed. Oxygen is formed at the strip connected to the positive pole of the battery, and hydrogen at the other strip, and each gas rises into the tube above it, displacing the water. Almost exactly twice as much hydrogen as oxygen is produced, and the process is called the "electrolysis" of water.

A voltaic cell, as we have seen, is liable to trouble through polarization, caused by hydrogen collecting on one of the plates and trying to set up another current in the opposite direction. In the electrolysis of water a similar opposing electro-motive force is set up, and when the battery current is stopped and the platinum strips are connected, a current begins to flow in the reverse direction, and continues to flow until the two gases have recombined, and the strips are once more in their original state. In this way the apparatus acts as an accumulator, for an electric current is supplied to it, and it gives back another current. It is important to understand that this apparatus—as is the case with all other accumulators—does not actually store up electricity, but energy. We may say that the electrical energy supplied to it is converted into chemical energy, and that this chemical energy is then converted back again into electrical energy. For practical purposes, however, this apparatus is not of much service.

#### The First Successful Accumulator

The first really useful accumulator was made in 1878 by Gaston Planté. The electrodes consisted of two strips of sheet lead made into a roll, but not touching each other, and placed in dilute sulphuric acid. A current was passed through, first in one direction and then in the other, and after several reversals of current one lead plate was found to be changed into a spongy condition, and the other was coated with peroxide of lead. This process is called "forming." When

the process was complete, the accumulator was ready to be charged and used. During the charging oxygen was taken from one lead plate and transferred to the other. During discharge, that is while the accumulator was being used to supply a current, this oxygen went back to its original place, and the current continued until the surface of both lead plates became chemically inactive. The accumulator, of course, could be charged and discharged over and over again.

Very many improvements have been made in accumulators since the time of Planté, but the working principle remains the same. All modern accumulators, except the very smallest, have several pairs of plates, all the positive plates being

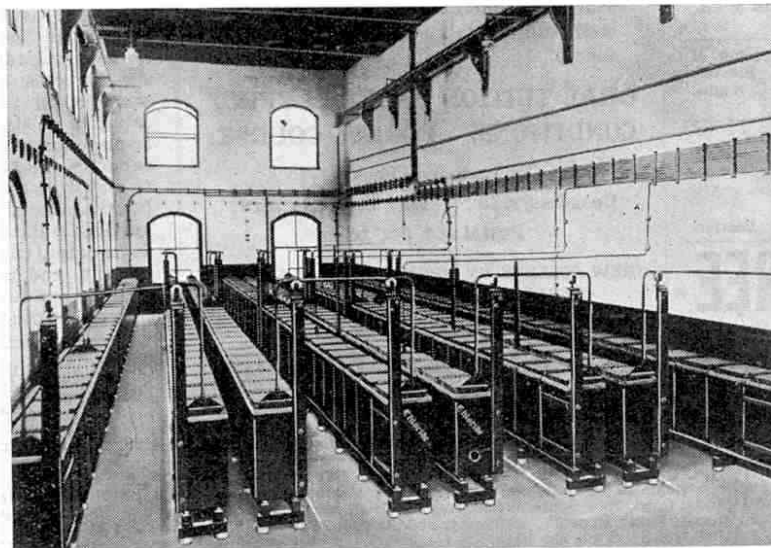

Photo by]

[Messrs. Chloride Electrical Storage Co. Ltd.

Battery of 264 cells at Blackburn Electricity Works. Capacity 1,400 ampere hours

(Cont. on page 156)

# Stamps for Sale

(For Rates see page 172)

**NONE FREE—NONE AS CHEAP!!** Farthing Stamp Approvals; about 1000 sent.—J. V. Wyk, 439, City Road, Old Trafford.

**STAMP COLLECTORS!** Be sure you get *The Philatelic Magazine*, the fortnightly stamp newspaper, 3d. from any newsagent, or 4d. post free from Publisher, 63, Windsor House, Westminster, S.W.1.

**FREE.** 50 Stamps, all different, to approval applicants for my famous sheets, all 1/4d. each.—Scott, 154, Wellesley Road, Ilford.

**ASSORTED Mixture** Foreign 1/3 per 1000. Popular approvals; any 4 stamps 1d. Any 50, 1/-.—Gall, 37, Avenue, Durham.

**JUNIOR PHILATELIC SOCIETY.** The new members list is now open and first subscription closes to September 1925. Write for particulars, J.P.S. blue book and sample copy of "The Stamp Lover" FREE. Mrs. H. P. Terry, 22, Kempshott Road, London, S.W.16.

**STAMPS.** 60 different, free to applicants for approvals, all 1/4d. each. Send postage.—Cox, 135, Cambridge Road, Seven Kings.

**BEGINNER'S PACKET** for 1/-, postage extra. Every fifth letter receives special prize.—Dixon, 24, Hollam Road, Milton, Portsmouth.

**FREE.** With approvals. Rarotongo, Barbadoes, Kenya, Cyprus, Sarre, 50 others. C. W. Glass, 72, Birch Road, Southville, Bristol.

**OCTAGON THESSALY FREE**, with approvals, 1/4d. and 1d. each. Bodman, 6, Alderman Road, Ipswich.

500 Different Stamps 2/6, 1000 different 5/-, 250 different unused 2/-, 1000 mixed 1/2. Selections on approval.—Reid, N.R.P., 6, Fountain Street, Low Moor, Bradford.

**FOREIGN STAMPS** on approval, all Farthing each.—Marshall, 96, Broad Street, Dagenham, Essex.

**5 TIBET 2/-.** Don't miss this fine set. 200 different, 1/3.—Place, Woodhurst, Huntingdon.

**THE "DIAMOND" PACKET** contains 1000 UNSORTED STAMPS from Convents abroad. 1/3 post free. 2 pkts., 2/5; 3 pkts., 3/6; 4 pkts., 4/6; 5 pkts., 5/6. Nerush, Importer (Dept. E), 2-22, Cathcart Hill, London, N.19.

**BRITISH EMPIRE. ALL MINT.**  
**WEMBLEY EXHIBITION**, 1d. and 1 1/4d., per pair 3d.  
 ditto per dozen pairs ... 2/8 1/2  
 ditto 1d. and 1 1/4d. stamps, 1d. post-card, 1 1/4d. letter card and 1 1/4d. envelope, complete set ... 9d.  
**NARU**, Pictorials, 1/4d. and 1d. Per pair ... 2 1/2d.  
**SOUTHERN RHODESIA**, new issue, 1/4d. and 1d. Per pair ... 2 1/2d.  
**POSTAGE EXTRA.**  
**ALEC KRISTICH** (N.R.P. 279), 82, Marchmont Street, Russell Square, London, W.C.1.

**SHEET (100) MILLION MARK STAMPS FREE!** Request approvals. Enclose postage.—Kraus & Co., 137, Cheapside, London, E.C.2.

**FREE.** Packet of MINT Stamps and packet of Mounts to all applicants for my approvals. For one month only I am allowing special discount.—C. Negus, Bury, Huntingdon.

**NO NEW EUROPE RUBBISH**  
**FREE!** 25 BRITISH COLONIALS, including West African, Tasmanian, Newfoundland, Jamaica, British Guiana, to applicants for approval selections. Ask to see my famous 1/4d. stamps.  
**FLEMING**, St. Winifred's, Christleton Road, Chester.

**225 DIFFERENT REVOLUTION WAR AND PEACE STAMPS FREE**  
 This packet is printed and priced to sell at 10/- and contains many "hard to get" sets, high-class pictorials, and odd values, catalogued from 1d. to 7/6 each. Given free to all requesting approval books and sending 4 1/4d. to cover cost of postage, packing, etc. (abroad 9d.)  
**R. WILKINSON,**  
 Provincial Buildings, COLWYN BAY.

**FREE!!** This tremendous advertising offer contains all the following:—60 different stamps (25 unused), inc. Brit. Cols., Indian Native State, Peru (scarce), Wurtemberg, unused imperf. Russia, Polish Republic, many War and Armistice. A truly fine collection of stamps. The outfit contains packet peelable hinges and a unique novelty that all collectors should have. A combination pocket folder and a mathematically correct perforation gauge. The whole lot, sent absolutely free to all genuine approval applicants.  
**Wembley Exhibition Stamp on every letter. LISBURN & TOWNSEND, LONDON ROAD, LIVERPOOL.**

# NORRISCO BARGAINS B

**22 Barbados (Cat. 5/7). Only 1/6. Postage Extra.**  
 This offer cannot possibly be repeated once present stocks are exhausted. The set is a very fine one including Jubilee, Nelson, Centenary, War, Victory, etc., all beautiful and wonderfully attractive stamps. SATISFACTION GUARANTEED ALWAYS.

**OTHER LONG SET OFFERS:—**  
 40 Brazil, fine set 1/- 30 Luxemburg, nice 1/-  
 50 Greece (Cat. 10/-) 1/6 set ... 1/-  
 75 Jugo-Slavia (Cat. 23/-) ... 3/3 7/1 ... 1/-  
 20 Memel, very cheap 1/- 50 Roumania (Cat. 6/7) 1/9  
 50 Turkish War Stamps 3/3

**FULL LISTS FREE.**  
**BRITISH COLONIALS WANTED** in large quantities by exchange: offers solicited.

**NORRIS & CO. (Dept. M.M.), LEABROOKS, ALFRETON, Derbyshire, England.**

50 French Cols. 9d.	50 Portugal Col. 9d.
100 U.S.A. 1/-	40 Belgium ... 1/-
150 Germany 1/-	50 Railway ... 1/-
150 Austria ... 1/-	50 Poster ... 1/-
150 Hungary 1/-	50 Entire Cards 1/-
50 Czech-Slov. 1/-	50 War Envs. 1/-
50 Roumania 1/-	300 Postage ... 1/-
50 Sweden ... 1/-	600 Postage ... 5/-
40 Italy ... 9d.	500 Revenue ... 5/-
40 Bavaria 9d.	1000 Revenue 17/6

Postage Extra.

Fine selections ready in separate countries.  
**J. Russell, Chetwynd, Shanklin Drive, Westcliff-on-Sea.**

**STAMPS FREE** Applicants for approvals sending postage receive either A COMPLETE SHEET OF 100 unused or 26 different unused, Peace, War, Air Post, etc. 60 page List profusely illustrated, 1d. only.  
**M. C. WATKINS, Stamp Importer, BARNET.**

**FELIX KEPT ON WALKING** for he never noticed this! 1000 Mixed Unpicked Foreign Stamps 1/-, 3000 2/-, (Postage abroad 3d. extra). J. L. Bondon says: "I am delighted with them."  
**G. P. Cranwell (M.M.), 55, Cowslip Road, London, E.18.**

**STILL CHEAPER**  
 12,000 Different Foreign and Colonial Stamps at 1/4d. each on approval. Many stamps usually sold at 1d. to 1/- each, now reduced from 1/4 to 1/2 of these prices. State countries desired. Collections bought for cash.—Hale, 52, Kentish Town Road, London, N.W.

# Wireless Operators Wanted

To meet the demand for Wireless Operators, we require a number of students immediately to train for these well-paid and fascinating appointments.

**ORAL TUITION UNDER PERFECT CONDITIONS. POSTAL COURSE.**

**Inclusive Fees:**  
**Boarders £30; Day Students £10;**  
**Postal £4 per term**

**NEW COLLEGE ON PROMENADE IN LEADING NORTH WALES HEALTH RESORT.**

Full particulars post free:  
**THE WIRELESS COLLEGE, COLWYN BAY**

**CHEAP LINES ALL DIFFERENT**  
 50 Britis: Colonials, 6d; 10 Peru, 2d.; 10 Brazil, 2d.; 10 Mexico, 2d.; 20 Argentine, 6d. Postage 1 1/4d. Special offer to those asking to see approvals—first four or last four lots above, post free 9d, or all five 1/1 1/4.  
**C. F. Hencher, Ruxley, Farncombe, Surrey.**

**"M.M." Back Numbers**

In the advertisement columns of the "M.M." a reader recently offered 2/6 per copy for certain early numbers of the "M.M." in order to complete his file. This offer indicates the value placed upon the "M.M." by Meccano boys, and we suggest that you should see that your file of copies is complete. Have your Magazines tastefully bound by some local book-binder or keep the Magazines in the special spring-back binder illustrated here. This binder has a strong stiff back, holds a large number of copies, and keeps them neat and clean. Covered in black imitation leather, tastefully tooled, lettered gold, its price is 3/- (post free) from—

**MECCANO LTD.**  
**BINNS ROAD - LIVERPOOL.**

**Electricity—(cont. from page 155)**

connected together, and all the negative plates together. This has the same effect as connecting voltaic cells in "parallel," that is more current is produced.

The electro-motive force of a single accumulator cell is about two volts, and in order to get a higher voltage several cells are connected in "series." Accumulators are rated as regards their current-giving capacity in "ampere-hours." For example, an accumulator that will give a current of six amperes for one hour, or of three amperes for two hours, is said to have a capacity of six ampere-hours. Sometimes accumulators are rated by their "ignition" capacity, that is their capacity when used to supply current for ignition purposes in petrol motors. The ignition capacity of an accumulator is about twice as great as its actual capacity for supplying a steady current, and in buying an accumulator it is necessary to make sure that the capacity stated is actual ampere-hours.

**NEXT MONTH:—**  
**MAGNETS**





**PERFORATIONS**

When the first postage stamps were issued by Great Britain in 1840 they were supplied in unbroken sheets, with no aid to assist in detaching an individual stamp from its neighbours. Consequently, postal officials and correspondents were compelled to cut the stamps apart as best they could, and we can readily imagine the resulting bother and waste of time, especially when no scissors were available! To prevent this, perforating was introduced.

**A Useful Invention**

One evening Henry Archer, a newspaper reporter, was sitting at the reporters' table of a London newspaper when he saw that another reporter, wishing to stamp a letter he had written, was pricking a series of holes in the space between the stamps with the aid of a pin, being unable to find either knife or scissors at the time. In this way he was able to separate a stamp from the others with accuracy and ease.

Archer was a man who had cultivated the habit of noticing small things, and he at once realised how great would be the benefit to the public if stamps could be sold ready "pricked." Within a very few weeks he designed a machine for perforating stamps and put it before the interested but critical Post Office authorities, who lent him sheets of stamps to experiment upon. Stamps perforated by Archer during these trials are exceptionally interesting to stamp collectors, for they

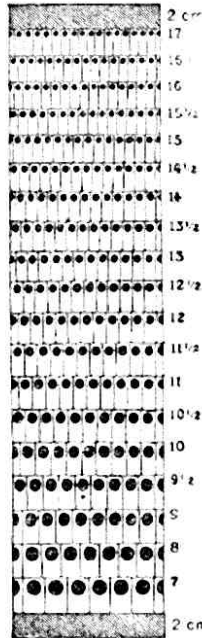

Fig. 1. Perforation Gauge

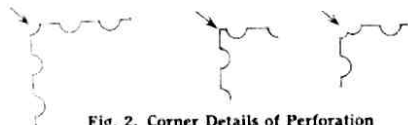

Fig. 2. Corner Details of Perforation

serve to illustrate the invention of what is practically the only improvement that has been made to stamps since they were first used. These experimental stamps are very rare, the lowest-priced of the three varieties being quoted at 50/- and the highest at £20.

Archer at last made a machine that satisfied requirements, and our first

**Why I Collect Stamps**

by Master Leslie Dugdale

*This Essay won the First Prize in our recent Essay Competition for Stamp Collectors*

When I turn over the well-thumbed pages of my stamp-album, a host of old friends smile cheerfully at me—friends I have known since I bought my first packet of stamps. There are varicoloured Kings and Queens; Rajahs and Presidents. Explorers and men of historical fame are also among my acquaintances. All are eager to greet me at the mere turning of a page. I am the proud owner of a miniature Zoo, an Aviary, a fine group of beautiful Buildings and Statues, and a whole army of busy Natives.

There are many reasons why I collect these stamps—artistic, geographical, historical and political reasons—for postage stamps give one a breadth of vision such as is equalled by no other hobby.

In the older issues of stamps we find past history. In the issues between 1914 and 1919 we have a complete and very compact history of the Great War, while with new issues, especially those of Neuropé, as it is termed, we can learn of the political condition of each country.

We learn of the more obscure parts of the globe, the strange occupations and customs of the natives and the curious names of currencies. We see the splendid architecture of the chief towns, and the

animals and birds that are peculiar to each land.

We must study variations in printing, the texture and watermark of the paper, the perforation and the gum, if we would know all about our treasures, and this teaches us to appreciate detail.

Then there is the fascination of the sheer beauty of our stamps, for all stamps are meant to be artistic and attractive in their various designs.

The common stamp of to-day is the rarity of to-morrow, so that which brings us pleasure to-day may bring us untold wealth in future days. The pleasure of collecting for the financial sake of the stamps is, however, as nought compared with that to be derived from stamps in the ordinary way.

I have named many of the reasons that bind me to stamps—for they have been dear to me since first I glued them in an old exercise book—without naming them! Philately's main attraction for me is its glamorous "magic carpet," for when I gloat over my collection by fire-light I can "put a girdle round the earth"—in an instant I can be transported to any clime my fancy wills. This, and the indescribable "something" that has made philatelists of thousands of men and boys, is "the reason why I collect stamps."

officially perforated stamp was sold on January 28, 1854. Since this date the majority of the stamps of the world have been issued perforated, and it is not very often that one can find a current stamp imperforate.

**Difficulties of Perforating**

There are two methods of treating the paper to enable the stamps to be separated easily. These are known as "perforation" and "roulette." In perforating a portion of the paper is actually removed, while in rouletting the paper is merely pricked or cut, no portion being removed.

To perforate stamps is not as simple a matter as might be supposed. At first thought it would seem that a large number of small punches could easily be arranged to perforate a whole sheet of stamps at one blow, there being holes drilled in the table below to receive the punches and the tiny discs of paper they would remove. Machines of this nature have been made and are called Harrow perforators, but in practice the punches continually break off and the holes in the bedplate as often become clogged with the little discs of paper.

**Single-line and Comb Perforations**

Perforating is now done by two types of machines. One of these machines punches only a single line at once and is known as a single-line perforator. When perforating is being done with this type of machine, the sheet of stamps is turned after the horizontal perforations have been made, and the vertical divisions are

then punched. The second type of machine has punches arranged in the form of a comb, the space between the "teeth" being equal to the width of one stamp (Fig. 3). In this manner three sides of every stamp in one row are perforated at the same time. The sheet of stamps is then moved upward one row and the second row is punched, thus completing the perforation of the first row and at the same time three sides of the second row.

Stamps perforated by a single-line machine may be distinguished from comb-perforated stamps by the appearance of the corner of the stamp. With a comb perforator there is always one hole exactly at the corner (Fig. 2), while with a single-line perforator there will usually be two

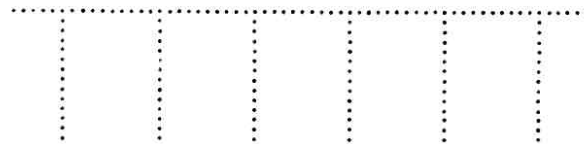

Fig. 3. Arrangement of Punches in Comb Perforator

holes partially overlapping each other at the corner or no hole at all. The two right-hand diagrams in Fig. 2 illustrate two varieties of single-line perforation.

Although some stamps may show double holes only at one corner, this is sufficient to indicate a single-line perforation. These double holes are caused by vertical and horizontal rows being perforated at separate operations, with the consequence that the two holes seldom exactly coincide where the rows cross one another, i.e., at the corners of each stamp.

As typical examples of the two styles of perforations it may be mentioned that the current British stamps are comb-perforated, and many, if not all, of the current stamps of the United States are single-line perforated.

(Continued on page 165)

# Brandes

THE

NAME TO KNOW IN RADIO



*Result of 15  
years' experience*

Jack chafes at an evening with his school text-books, but he is always willing to further his education in a more pleasurable way—by Wireless. He gets the facts distinctly and accurately with Brandes "Matched Tone" Headphones—and is a fearsome authority on sporting records to the obvious discomfiture of his school-fellows.

**PRICE 25/-**

BRITISH  
MANUFACTURE  
(B.B.C. Stamped) and  
conform to all new  
licensing regulations.  
Manufactured by:—  
Brandes Limited,  
at Brandes Works,  
Slough, Bucks.

**BRANDES LIMITED**

Walmar House, 296, Regent Street, W.1.

\*Phone—Mayfair 4208-9.

Trade enquiries invited

Glasgow—47, Waterloo St. Newcastle—5/6, Post Office Chambers

*Matched Tone*  
TRADE MARK  
Radio Headphones





# SIGNALLING TO AMERICA

## How Marconi Transmitted his First Signals Across the Atlantic

**W**IRELESS TELEGRAPHY has become such an important feature in the everyday life of the world that it is difficult to realise that 25 years ago it did not exist as a practical means of communication. The enormous advance in wireless communication since that time has been due very largely to the inventions of Marconi, who at the age of 50 is in a position to look back upon a succession of achievements such as few men have accomplished.

Marconi did not invent wireless telegraphy any more than Watt invented the steam engine, Stephenson the locomotive, or Morse the land telegraph. What Marconi did was to take hold of a crude idea—something that was, indeed, little more than a scientific curiosity—and develop it into a practical system of wireless communication on a commercial basis.

### The Beginnings of Radio

Guglielmo Marconi was born on April 25, 1874, at Bologna in Italy, his father being Italian and his mother Irish. He was educated at the University of Bologna, and electricity, which he studied under Professor Righi, became his chief interest. It was probably from Righi that Marconi received his original inspiration.

In order to understand the vast importance of Marconi's work it is necessary to try to obtain some idea of the state of things when he first began to experiment. About the year 1863 the famous British scientist Clerk Maxwell advanced the theory that electricity, like light, travels through space by means of the ether. Some twenty years later a German scientist, Heinrich Hertz, became greatly interested in this theory, and in 1888 he succeeded in demonstrating experimentally the existence of wireless waves. The apparatus used by Hertz consisted of an "oscillator" to produce the waves and a "resonator" to detect them. The oscillator consisted of two metallic plates joined by a metal rod having at its centre a spark-gap between two polished brass balls. The resonator was simply a circle of wire having a similar spark-gap. The oscillator was connected to an induction coil, and when a spark jumped across the gap between the brass balls, a similar spark leaped across the spark-gap of the resonator, although this was some distance away from the oscillator and not connected with it in any way.

Hertz's experiments excited widespread interest among scientists, and very soon several workers were endeavouring to find some means of using the Hertzian waves for wireless communication.

### Invention of the Coherer

The first difficulty was to devise an apparatus much more sensitive than Hertz's resonator, for the detection of the waves. Such an apparatus, called a

"coherer," was invented in 1890 by Edouard Branley, a Frenchman. The coherer consisted of a glass tube containing metal filings. Through each of the closed ends of the tube was passed a wire, which terminated in a silver plug. Both plugs were very close together but not actually touching each other. (See Fig. 1). When the wires were connected to an



Guglielmo Marconi

electric battery it was found that as long as the filings lay loosely in the tube they offered a very high resistance and the battery current could not pass. When electric waves reached the coherer, however, the filings cohered and their resistance was so greatly reduced that the current was able to pass without difficulty. This current then operated either an ordinary telegraph sounder or a Morse printer.

In order to cause the filings to de-cohere and return to their original loose condition in which they offered high resistance, it was necessary to give the tube a gentle tap. In 1895, Popoff, a Russian physicist, introduced a tapping arrangement which automatically returned the filings to their original state after the passage of an electric wave.

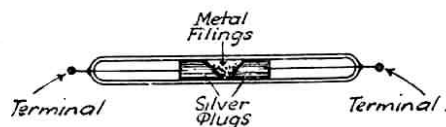

Fig. 1. Coherer

### Marconi Sets to Work

These discoveries of Hertz and his successors paved the way for wireless telegraphy, but it was left to Marconi to weld them together into a practical system. His first transmitting apparatus consisted of an oscillator on the lines of that used by Hertz, but in an improved form, and his receiver was a coherer similar to that of Branley, but more sensitive.

Marconi's first experiments were conducted in his father's garden near Bologna. After several attempts he succeeded in transmitting signals over a distance of about a mile. He soon found that his opportunities for experiment were too limited in Italy, and in 1893 he came to England and readily obtained the assistance of Sir William Preece, Chief Electrician to the British Postal Service.

### Success in England

Marconi commenced experiments with his oscillator in a room at the General Post Office in London, and the receiving apparatus on a roof more than 100 yards away. These experiments were successful, and afterwards he moved his apparatus to Salisbury Plain for further tests on a larger scale, before representatives of the Army and Navy. Here he succeeded in transmitting signals over a distance of about two miles, and thus proved that his system was of practical value. By the end of 1897 he was able to transmit over a distance of 15 miles, while in the following year signals were successfully exchanged between Wimereux, near Boulogne, and Chelmsford, a distance of over 80 miles. It was also found that messages could be passed between the South Foreland Lighthouse and the East Goodwin Lighthouse without any difficulty, through fog, rain, or storm.

By the beginning of 1900 regular communication was established between ships and land stations over a distance of 100 miles. Shipping companies then realised the great value of Marconi's invention and began to instal wireless apparatus on their ships. The British Admiralty also saw the possibilities of wireless, and in July 1900 they contracted for the installation of the Marconi system on 26 warships and six land stations.

### Wireless Tuning

In 1897 Sir Oliver Lodge pointed out the greatly improved results to be obtained by "tuning" the wireless transmitter and receiver. Wireless tuning consists of adjusting the aerial of the receiving station so that it has the same natural rate of oscillation as that of the transmitting station.

A simple analogy will make clear the principle of tuning. Suppose we have two tuning forks of the same pitch placed close together. If we strike one fork so that it sounds its note strongly, the other fork will also begin to sound, although more faintly. On the other hand, if we

(Continued on page 161)

HOUSES  
TOWERS  
BRIDGES

# LOTT'S BRICKS

STATIONS  
CHURCHES  
COTTAGES  
Etc.

OF ARTIFICIAL STONE

AN AMUSING AND DELIGHTFUL PASTIME FOR ALL MODELLING PURPOSES

SUITABLE FOR BOYS OF ALL AGES

BUILD A MODEL VILLAGE FOR YOUR MODEL RAILWAY



Twelve Models contained in Box 2. Tudor Series.  
Obtainable of all Leading Stores and Toy Dealers throughout  
the Kingdom.

## TUDOR BLOCKS.

Box 1. Complete, 3/6      Box 2. 12 Designs, as illustrated 7/6  
Box 3. Beautifully packed in Wooden Box, with  
Tray containing Trees, Fences, and many  
Original Design ... .. 17/6

## SERIES "B."

Box A. Complete with Plans, Bricks, Roof, Fences  
and Trees ... .. 5/-  
,, 1. 18 Designs with Plans, Bricks, Roof, Fences  
and Trees ... .. 10/-  
,, 3. Complete Designs to Build a Model Village 17/6  
,, 6. Plans, Bricks, Roofs and 71 Designs ... 35/-

## GARDEN SETS.

Containing Trees, Fences, Roofs, Shells, Shrubs, etc.  
Box 1 4/-      Box 2 6/-

## LONDON STOCKISTS:

Army & Navy Co-operative Society Ltd.	Harrods Ltd.
J. Barker & Co. Ltd.	Hamleys Ltd.
Benetfink & Co. Ltd.	Peter Robinson Ltd.
A. W. Gamage Ltd.	Selfridge & Co. Ltd.
Civil Service Supply Assoc. Ltd.	W. Whiteley Ltd.
	Shoolbred & Co. Ltd.

## LOTT'S BRICKS LTD., WATFORD, England

WRITE FOR ILLUSTRATED LISTS

## Accessories of Established Reputation

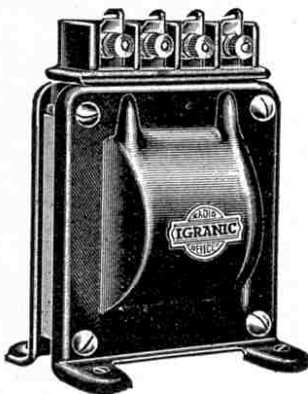

INTERVALVE TRANSFORMER.  
(Pat. No. 205013)

### The universal popularity of "IGRANIC" RADIO DEVICES

is your surest guarantee of radio success. Scientifically constructed of the finest quality materials by experienced radio engineers in a well-equipped factory. Critically tested to ensure correct and reliable performance.

"IGRANIC" RADIO DEVICES include Honeycomb Coils, Intervalve Transformers, Filament Rheostats, Potentiometers, Variocouplers, Variometers, Coil Holders, Telephone Transformers, etc., etc.

Write for Leaflets Nos. Z.186.

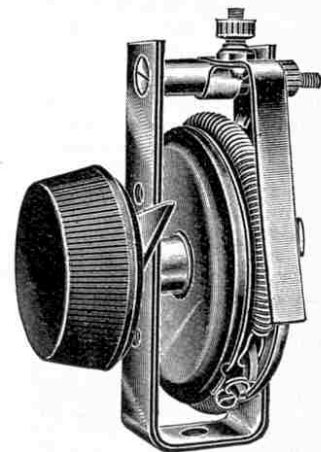

FILAMENT RHEOSTAT.  
(Pat. No. 195903)

149, Queen Victoria Street,  
LONDON.

Manchester : 30, Cross St.

Birmingham : 73/4, Exchange Bldgs.

Glasgow : 50, Wellington St.



Works :

Elstow Road, BEDFORD.

Cardiff : Western Mail Chambers.

Bradford : 18, Woodview Terrace,  
Manningham.

Newcastle : 90, Pilgrim St.



**THE**  
*"Revo"*  
REGD

**LITTLE GEM CRYSTAL SET**  
**5/6**  
Postage extra. Plus 1/- Tax nett.  
Approved by the Postmaster General.  
Perfect Reception. It's Splendid.



**"REVO"**  
**LIGHTWEIGHT HEADPHONE**  
British Made at Our Own Works. **19/6** 4000 Ohms Each  
Instantaneously adjustable without releasing any screws. A better Headphone is not made.

**"REVO"**  
**LOUD SPEAKER**  
The Senior Speaker at the Junior Price. Complete with Cord  
**£3 15 0**  
Height overall, 22" Trumpet 14" diam. Satisfaction Guaranteed.  
*Obtainable from any dealer or the manufacturers:*

**THE CABLE ACCESSORIES CO. LTD.,**  
TIPTON, STAFFS.

**BOYS! Make your own Variable Condensers**  
from our sets of parts, in the same way that you would make your Meccano Model.

**Finest Quality. All Orders Post Free.**

.001 mf. ...	8/3	.0002 mf. ...	4/6
.0005 ...	6/-	.0001 ...	4/-
.0003 ...	5/-	.00005 ...	3/9

If required without circular end plates, subtract 1/3.  
All Igranitic parts stocked.

**The H.S. RADIO CO.,**  
**36, WILLES ROAD, LEAMINGTON.**  
Buy British Made Goods.

**BOOKS ON WIRELESS**

**Successful Wireless Reception.** By Paul D. Tyers. Well illustrated. Post free 1/9.

**Wireless at Home.** By H. De a Donisthorpe. A Guide to Receiving. Illustrated. Post free 7d.

**Wireless Circuits and Diagrams.** 100 diagrams of circuits and connections. Post free 7d.

**How to Make a Simple Wireless Receiving Set.** By A. V. Ballhatchet. Illustrated. Post free 7d.

**How to Make a Valve Receiving Set.** By A. V. Ballhatchet. Practical. Post free 7d.

**Wireless Facts and Figures.** By A. V. Ballhatchet. Formulae and Tables. Post free 7d.

**How to Make Wireless Amplifiers.** By A. V. Ballhatchet. Illustrated. Post free 7d.

Send Post Card for Complete List.

**PERCIVAL MARSHALL & CO.,**  
66M, Farringdon Street, LONDON, E.C.4.

**Signalling to America—(cont. from page 159)**

try the experiment with two forks of different pitch the second fork will remain silent.

The explanation of this is that the two forks of similar pitch have the same natural rate of vibration, whereas the other fork vibrates at a different rate. When we strike the first fork it vibrates at a certain rate and sets in motion in the air sound waves of a certain length. When the first wave reaches the other fork of the same pitch it sets it vibrating slightly, and as this fork has the same rate of vibration as the first fork, the succeeding waves as they arrive add their impulses until the second fork sounds. In the case of the fork of different pitch, however, the first wave sets it vibrating, but as this fork has a different rate of vibration from that of the first fork, the succeeding waves reach it at wrong intervals. Instead of adding together their impulses they interfere with one another and consequently the fork does not sound.

**Avoiding Confusion**

In exactly the same manner, if a wireless receiving aerial is tuned so that its rate of oscillation is the same as that of a particular transmitting aerial, it will respond readily to the waves from the latter. Also it will be comparatively unaffected by waves from other transmitting aerials having different rates of oscillation. By means of tuning, therefore, it is possible to pick out the particular message that it is desired to hear and cut out to a great extent all other messages. In this way confusion is avoided.

In his first system Marconi used an aerial that was charged directly. Only a very small amount of energy was available, therefore, and the electric waves quickly decreased in power or "amplitude" as it is called. The result was that the range was very limited and tuning was impossible. The apparatus, shown in Fig. 2, consisted of an induction coil C with a battery B connected to the primary circuit. The secondary circuit was connected direct to the spark-gap SG, which had one ball connected to earth and the other to the aerial.

**Marconi Improves His Apparatus**

Marconi obtained very much better results with an improved apparatus introduced in 1900. The new apparatus, shown in Fig. 4, had a condenser C, which stored up electricity in the same manner as does a Leyden jar. A coil of wire C1 was introduced into the circuit, and discharge was through the induction coil and across a spark-gap as before. The condenser stored up a great amount of energy each time it was charged,

and on being discharged it imparted this energy to the aerial by induction from the coil C1 to the coil C2, one terminal of which was connected to the aerial, the other terminal going to earth.

As our diagram shows, there were two distinct circuits. The first consisted of the induction coil, the condenser and the primary tuning coil; and the second of the aerial and the secondary tuning coil. These circuits were tuned so that the oscillations set up by the charge and discharge of the condenser were repeated by induction in the aerial. With this transmitting arrangement more energy was radiated and the waves decreased in amplitude at a much slower rate.

A similar tuning arrangement was also introduced in the receiving apparatus as shown in Fig. 3, the signals being transferred from the aerial circuit to the coherer circuit by induction.

Although these modifications produced better results, Marconi found that his apparatus even yet left a great deal to be desired from the points of view of both speed and sensitiveness. A combination of the coherer detector and Morse printing apparatus made it impossible to work at a greater speed than

17 or 18 words a minute, and the distance over which messages could be received successfully was very limited. Next month we shall describe how Marconi further improved his apparatus and made possible the conquest of the Atlantic.

(To be continued)

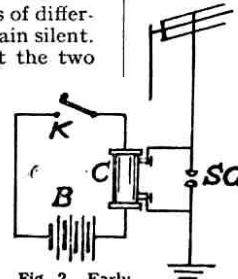

Fig. 2. Early Transmitting Apparatus

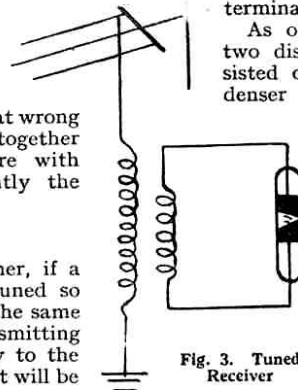

Fig. 3. Tuned Receiver

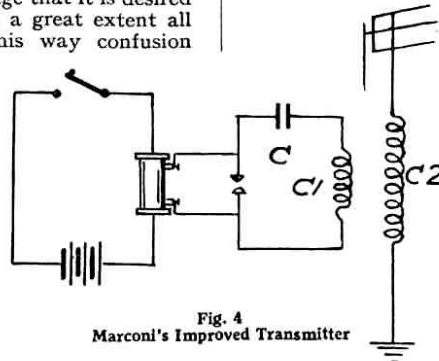

Fig. 4. Marconi's Improved Transmitter

**Catalogues Received**

From Messrs. Igranitic Electric Co. Ltd. (149, Queen Victoria Street, London), we have recently received an illustrated booklet giving full particulars of their many radio accessories, including coil-holders, variometers, variocouplers, transformers, filament rheostats, vernier-friction pencils, etc. The name of "Igranitic" is closely associated with "Honeycomb" Duo-Lateral Coils, and in this connection the firm have published an interesting handbook describing these coils and their uses, and also giving a number of recommended circuits. Both publications are of real interest and help to the wireless enthusiast, and they will be sent (post free) on application, to any reader mentioning the "M.M."

**The "Curvograph"**

A fascinating device, with the aid of which innumerable beautiful designs may be made, is the latest production of the well-known educational publishers, Messrs. Philip & Lacey. The "Curvograph," as this invention is called, consists chiefly of a metal template, scientifically constructed and accurately machined. Perhaps the greatest charm of the "Curvograph" lies in the fact that no artistic talent is necessary to draw any of the wonderful variety of designs, and it may be used with equal pleasure and success by young and old alike. There are many happy hours of real enjoyment in store for the "Curvograph" owner, and this ingenious device should make many friends among Meccano boys. Each outfit includes a supply of drawing paper, a selection of designs and a pencil, the whole set being neatly packed in a strong cardboard box. Full particulars will be found in our advertising pages.



**THUNDER ISLAND**

A Story of Three Castaways—  
not forgetting Jil,  
An entirely new Serial,  
By **JOHN HUNTER**

**POOR DEAR ESME**

A Humorous Serial of a Boy  
sent to a Girls' School,  
By **A. M. BURRAGE**

**EIGHT STORIES  
OF ADVENTURE,  
SPORT AND  
HUMOUR, AND  
"THE  
BOSUN'S DEN"**

**ON SALE NOW at all Newsagents and Bookstalls.**

GEORGE NEWNES, LTD., 8-11, Southampton Street, Strand, W.C.2.

**7D**