

The System Explained

In Fig. 3 we illustrate a wall type of telephone provided with the automatic dial, with a subscriber in the act of making a call. It will be seen that the apparatus consists of the usual telephone outfit for a central battery circuit (see the "M.M." for February, p. 91) together with a dial or calling device. The latter consists of a fixed circular white disc bearing the numbers 1 to 9 and 0 arranged in a circle, over which is mounted on a central axis a black circular disc pierced with ten holes which, when this disc is in its normal position, come over the numbers on the fixed disc below.

To call a number, say 7014, the subscriber first lifts his receiver from its hook and then inserts his finger in the hole above the figure "7" and rotates the disc in a clockwise direction until his finger reaches the finger-stop in the right-hand lower corner. On removing his finger, a spring, wound up by the action of dialling, returns the disc to its normal position, during which movement a series of electrical impulses is sent out over the line wires to the exchange.

The subscriber next inserts his finger in hole "0" and brings the disc round as before, following this by dialling "1" and "4." Immediately he has dialled the "4" the bell on the premises of subscriber 7014 rings. If the wanted subscriber is already engaged, the caller hears a distinctive buzz in his receiver. If at any time in the course of making a call the wrong number should be dialled, the subscriber merely has to press the receiver hook and begin the process again.

To terminate a call the subscribers replace their receivers. There is no hand generator for ringing-up or ringing-off since this is a central battery system, power being obtained from the exchange over the subscriber's line.

At the Exchange

As soon as a subscriber removes his receiver from its hook, current flows through the line circuit and the action of the dial is to interrupt this current a number of times corresponding to the number dialled, this action taking place when the dial is returned to normal by the spring. Thus, when the dial is returning after being pulled round for "7," the line current is interrupted seven times.

When the receiver is removed from its hook, in addition to causing current to flow through the local telephone circuit, a relay switch is operated at the exchange which prevents any-

one calling the subscriber until he replaces his receiver, and further, a rotary line switch (Fig. 1) is brought into action. Each line is provided with an individual rotary line switch for its exclusive use, and this serves the purpose of reducing by over ten times the amount of other apparatus necessary at the exchange.

The Rotary Line Switch

The line wires are connected to the rotating portion of the switch. There are twenty-five sets of contacts arranged in the form of a semi-circle, with any of which the line wires may be connected by rotating the moving part. Each of these twenty-five sets of contacts is connected to the corresponding sets of ninety-nine other rotary line switches belonging to ninety-nine other subscribers. Further, each of the twenty-five sets is connected to another type of switch termed a "first group selector."

When the receiver is removed from its hook on the subscriber's premises the rotary line switch comes into action and the "wipers" meet the first set of contacts. If, however, one of the ninety-nine other switches belonging to the ninety-nine other subscribers is already using the first set—that is, if the first set

is engaged—the wipers automatically move on to the next, and so on, until they find a vacant set of contacts and consequently a corresponding vacant first group selector. This process is technically known as "searching for trunks."

The First Group Selector

When a disengaged trunk is found, the subscriber is connected through it with a first group selector, the whole of this action being accomplished in the short interval of time between the lifting of the receiver and the dialling of the first digit.

The function of the first group selector is to respond to the first digit dialled, that is, the "thousands" digit, and to connect the subscriber's apparatus via another trunk to a "second group selector" that can deal with the second or "hundreds" digit.

A skeleton outline drawing of the group selector is shown in Fig. 2. It consists of a bank of one hundred sets of fixed contacts arranged in groups of ten in a semi-circle on each of ten levels, as shown in the figure. An upright shaft capable of both vertical and rotating movements carries a pair of contact wipers as shown, and by suitably combining the vertical and

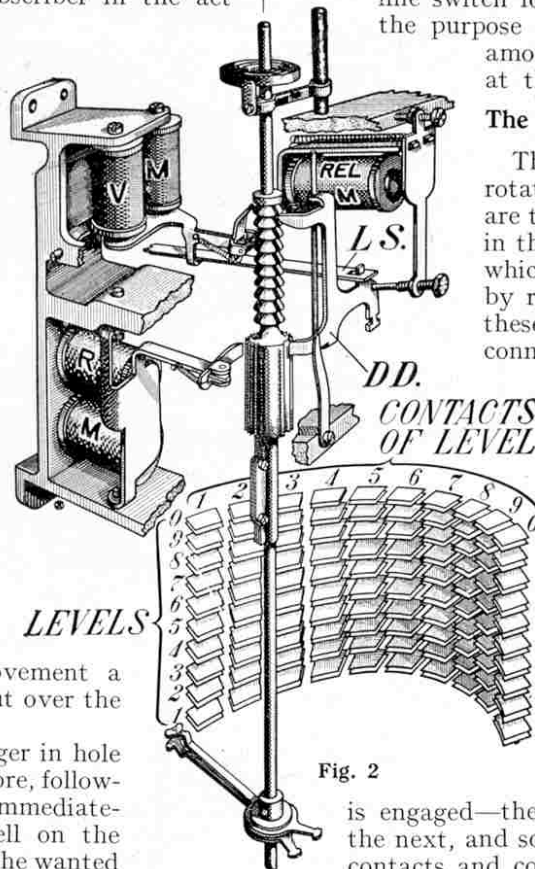

Fig. 2



Fig. 3

rotary movements of the upright shaft these wipers may be brought into contact with any one of the hundred sets of contacts.

The twenty-five trunks from the rotary line switch terminate in the wipers of twenty-five first group selectors. The normal position of the wipers is as shown in the diagram, not making contact at all, but when the subscriber whose call we are tracing dials the first digit "7," the shaft carrying the wipers is raised seven successive times by the vertical lifting magnet VM. This brings the wipers opposite to the seventh level of the bank of contacts and the rotating magnet RM immediately moves the wipers into contact with the first set in this level.

Each of the sets of contacts in this level is connected by further trunks to second group selectors, whose duty it is to deal with calls to subscribers in the seven-thousands group. This rotary action is similar to that of the rotary line switch already described and serves the same object of saving apparatus, the wipers moving on automatically step by step until a vacant trunk belonging to a vacant second group selector in the seven-thousands is found.

Before passing on to the second group selector it might be mentioned that at the termination of the call the release magnet Rel. M. comes into action and allows the wipers to be returned to their normal position ready for another call.

The Second and Final Selectors

The operation of the second group selector, whose function it is to deal with the hundreds digit of, in this case, the seven-thousand group of lines, is exactly the same as that of the first group selector. In the present case, when the number 7014 is being dialled, the wipers will be raised ten times to the "0" level, when they will rotate as before until they come into connection with a disengaged trunk on this level, thus connecting the subscriber's apparatus to the final selector. This latter also is similar in construction to the first group selector, but instead of dealing with only one dialled digit it responds to the dialling of both the tens and the units digits.

When the tens digit (in this case "1") is dialled, the wipers of the final selector will be raised to the first level and then, following the dialling of the units digit, "4," they will be stepped round four times, so that they come into contact with the fourth set on the first level.

This set of contacts is connected to the line terminals of subscriber 7014 and if his telephone is disengaged the apparatus will immediately connect an automatic ringer to his line. This ring will be heard faintly in his receiver by the originator of the call, so that he is assured that the connection is complete and the apparatus in working order. The ringing apparatus continues to operate intermittently until either the called subscriber lifts his receiver to answer, or the originator replaces his receiver, having failed to obtain an answer. The automatic meter to record the call does not operate until the called subscriber lifts his receiver, so that there is no fear of an incomplete call being charged for.

Should the wanted subscriber's telephone be engaged, the caller will hear the distinctive "busy" buzz in his receiver, as already described. He will then replace his receiver and re-dial when he thinks a sufficient interval has elapsed for the

"Meccano Standard Mechanisms"

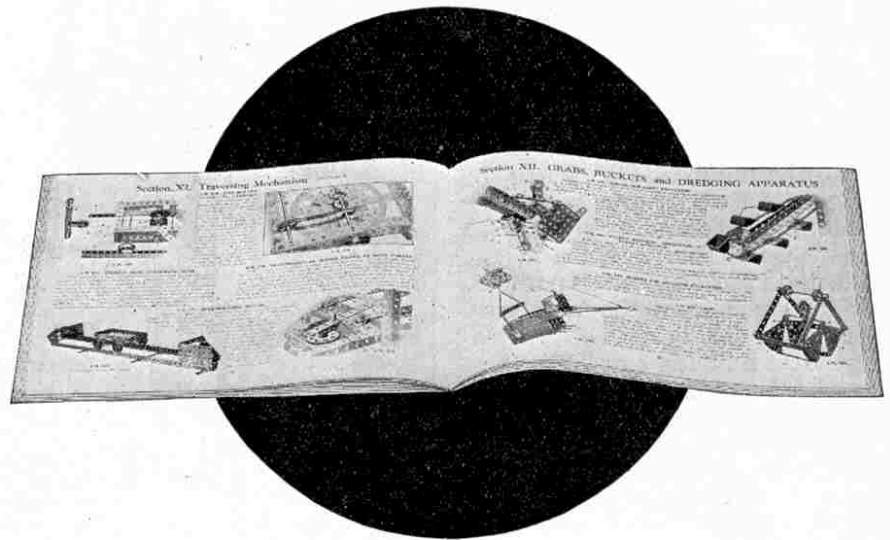

There are a number of Meccano movements that have to a certain extent become standardised; that is to say, they may be applied to more than one model—in most cases without any alteration, but in some few instances with only slight alterations to the original movement. These have been collected and classified, and a selection has been published in each issue of the "M.M." for the last few months as "Meccano Standard Mechanisms."

The entire collection, including the movements already published in these pages and many others in addition, may now be obtained in the form of a new Manual entitled "Meccano Standard Mechanisms." This publication consists of 48 pages, $9\frac{3}{4} \times 6\frac{1}{2}$ ", and contains over 140 illustrations in half-tone. The various devices have been arranged so that immediate reference may be made to any particular motion that it is desired to incorporate in a model, and the book should be of special value in assisting inventive boys to embody correct engineering principles in their new structures. The clear and detailed manner in which the various mechanisms are described will be appreciated on examining the specimen illustration reproduced on this page. No keen Meccano boy will consider his equipment complete without a copy of "Meccano Standard Mechanisms."

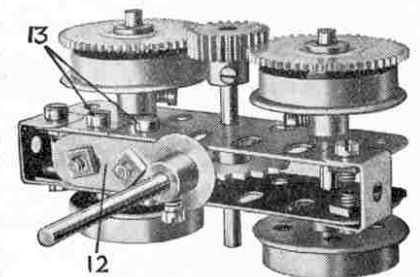

S.M. 165a, Power-driven Bogie
(Traversing Mechanism)

The book is divided into thirteen principle sections, as follows:—

required number to have become disengaged.

The rotary line switch and the first, second and final selectors all remain in their positions and are reserved for the exclusive use of the conversation until the call is terminated by the replacement of the receivers, which automatically releases the whole series and leaves them free to deal with other calls.

NEXT MONTH:—

AUTOMATIC EXCHANGES IN LARGE AREAS

- I. Gear Ratios: Methods of Speed Reduction and Acceleration.
- II. Belt and Rope Mechanism.
- III. Pulleys and Pulley Blocks.
- IV. Levers.
- V. Clutches, Reversing and Drive-Changing Mechanism.
- VI. Brakes and Retarding Appliances.
- VII. Roller and Ball Bearings, etc.
- VIII. Steering Gear.
- IX. Screw Mechanism.
- X. Overhead Trolleys and Trucks for Gantries, etc.
- XI. Traversing Mechanism.
- XII. Grabs, Buckets and Dredging Apparatus.
- XIII. Miscellaneous Appliances.

The price of "Meccano Standard Mechanisms" is $1/1\frac{1}{2}$ post free. Overseas, price $1/7\frac{1}{2}$ post free. It may be obtained from any Meccano dealer, from our Overseas agents (addresses on page 288), or direct from Meccano Ltd., Binns Road, Liverpool.

A NEW MECCANO MODEL

4-2-2 LOCOMOTIVE AND TENDER

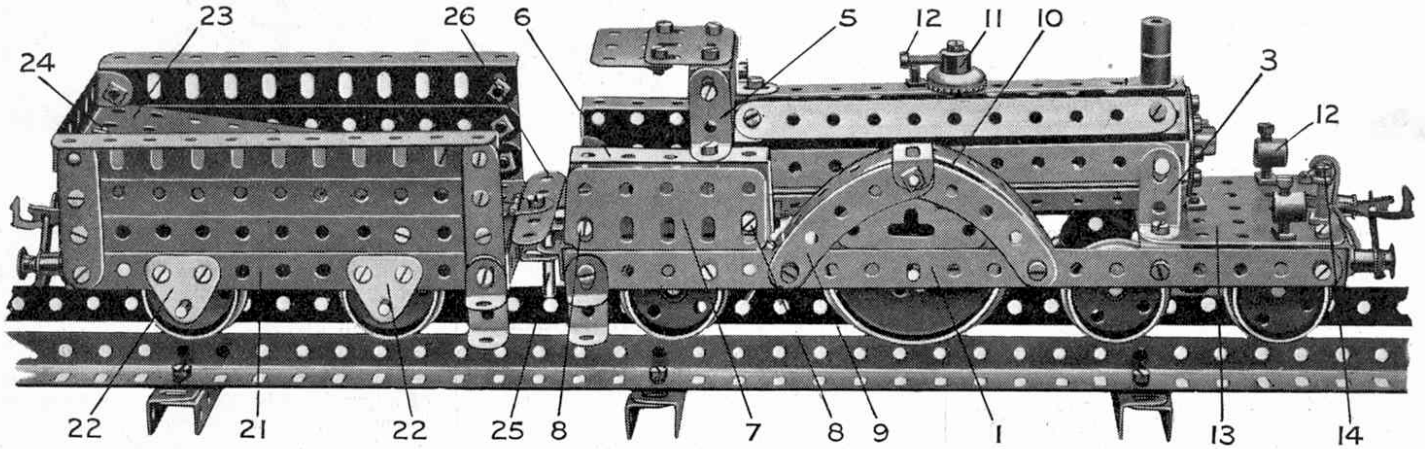

WE illustrate a Meccano model of an old-style Midland "single-wheeler" locomotive, constructed from drawings submitted by Keith W. Cameron, of Wallasey, Cheshire, in the recent "Locomotive" Competition. This interesting model gained an award for its designer, and we feel sure that our readers will agree with the judges' opinion that its simplicity and gracefulness of line deserves very high praise indeed. In view of the fact that its construction follows sound and instructive principles, we decided to publish details of its design, in order that all Meccano boys who wish may build it, and so judge of its merits for themselves.

The engine frame is built up from two 9½" Strips 1 joined at the points 2 (Fig. A) by 2½" × ½" Double Angle Strips, and further strengthened at each end by 2½" Angle Girders. The boiler is composed of seven 5½" Strips bolted at either end to a Bush Wheel by means of Angle Brackets. It is supported at the smoke-stack end by 1" × ½" Angle Brackets 3, while an Angle Bracket secured to the lowest hole of the rear Bush Wheel is bolted at 4 (Fig. A) to the floor of the cab.

The cab roof consists of two 1½" Flat Girders joined together and bolted by Angle Brackets to 1" × ½" Brackets 5. 2½" × 1" Double Angle Strips 6 and Flat Girders 7 bolted together by Angle Brackets at 8 form the sides, which, in turn, are bolted by Angle Brackets to the footplate.

The wheel covers for the main drivers are each constructed from two 2½" Curved Strips 9 and a 5½" Strip 10 bent to the same curvature. A Corner Bracket is secured in the centre as shown.

A safety valve in the centre of the boiler consists of a ¾" Con-rotate Wheel 11, secured by means of a ¾" Bolt and carrying a further ½" Bolt 12. The smoke-stack is composed of two Threaded Bosses mounted on the shank of a ¾" Bolt passing through the top strip of the boiler. Two lamps are carried on the front of the engine-frame and consist of Threaded Bosses 12 mounted on the upturned shanks of ½" Bolts secured in the 2½" × 2½" Flat Plate 13, and gripped in position by 7/32" Bolts inserted in the tops of the Bosses.

A piece of Spring Cord, secured to a ¾" Bolt 14, represents the front vacuum brake pipe connection.

It will be noticed from Fig. A that the front bogie consists of two 2½" Strips 15, bolted to a Double Bracket 16. It

is attached to the locomotive frame by means of a ¾" Bolt, secured by two nuts on its end to the Flat Plate 13. A small compression spring is placed on the bolt between the Double Bracket and the base plate. The rear trailing wheels 17 are mounted on a 1½" Rod passed through two Trunnions 18 bolted to the under-side of the footplate. The wheels are retained in their correct position by means of a Collar 19, spaced between two Washers.

The driving wheels are built up from Face Plates and Wheel Flanges, and are secured to a 3" Rod 20. They are spaced in the correct position in the centre of the frame by means of three Washers placed between the boss of each Face Plate and the sides 1 of the engine.

Steps are provided at the footplate end of the loco frame and on the tender. These are fashioned from a 1" × ½" and a ½" Angle Bracket bolted together.

Construction of the Tender

A 5½" × 2½" Flange Plate 21 forms the base of the tender and the sides are each built up from two 5½" Strips and one 5½" Girder. The back consists of four 2½" × ½" Double Angle Strips. The wheels are carried on axles journalled in 1" Triangular Plates 22 bolted to the base plate. A 4½" × 2½" Flat Plate 23 is secured in the tender by

means of an Angle Bracket bolted to the back at 24, and a 2½" × ½" Double Angle Strip at the other end of the plate.

The loco and tender are coupled together by means of a 1" Rod 25, passed through two Angle Brackets. An extension of the footplate consists of a 1½" Flat Girder and a 2½" Strip 26, bolted by means of a Hinge to the tender. Meccano Spring Buffers are fitted to both loco and tender.

If desired a Meccano Clockwork or Electric Motor may be fitted in the tender to supply the motive power, the drive being led down by any suitable gearing to the wheels. A similar arrangement of the drive will be found in the Locomotive and Tender shown in

the new complete Manual (see Model No. 715).

The model may be adapted to run on Hornby rails by placing the wheels a little closer together, although this necessitates a slight revision in the design of the engine frame.

Parts required :

2 of No. 1A	1 of No. 29	2 of No. 109
13 " " 2	131 " " 37	4 " " 111
1 " " 5	11 " " 38	3 " " 111A
4 " " 6	2 " " 46	1 " " 114
1 " " 6A	1 " " 48	4 " " 120A
2 " " 9	10 " " 48A	2 " " 121
2 " " 9D	1 " " 52	2 " " 126
1 " " 11	1 " " 53A	2 " " 133
41 " " 12	6 " " 59	2 " " 137
8 " " 12B	4 " " 64	1 piece of No.
3 " " 16	2 " " 72	58
3 " " 18A	4 " " 77	1 spring from
1 " " 18B	4 " " 90	Buffer No.
10 " " 20	2 " " 103F	120A
2 " " 24	3 " " 103H	

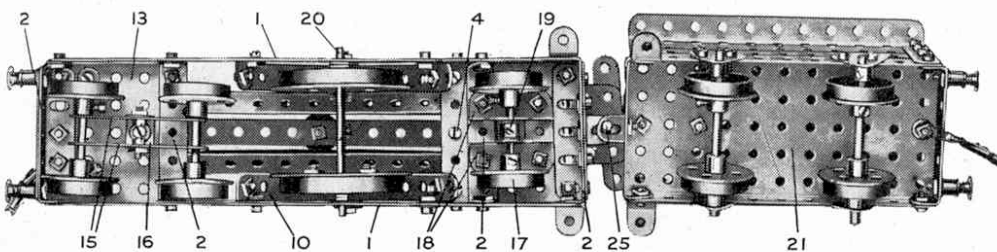
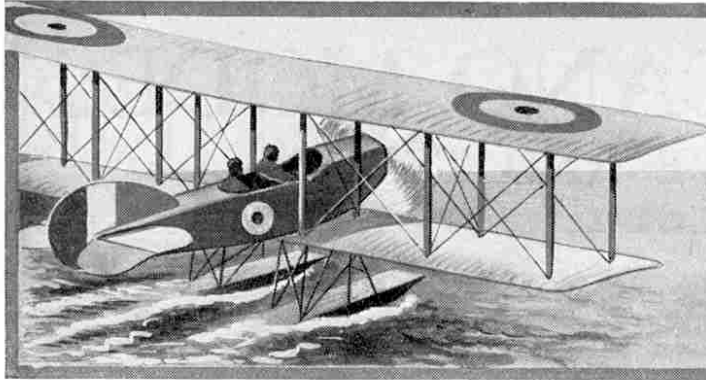

Fig. A



Air News of the Month

Aerial Surveying

The 1924/25 Report issued by the Director of Civil Aviation throws an interesting light on the extent to which aerial photographic maps have become popular. Representatives of one firm alone spent 120 hours in the air in connection with this work and the maps produced covered such widely different scenes as country estates and congested areas of towns. Such maps have proved of considerable assistance in drawing up extension progress reports on factory building, road making, etc.

Listening-in Aloft

During recent experiments in a French air express, passengers flying between London and Paris have been able to listen to broadcast programmes while crossing the Channel. In the fore part of the machine a mechanic in charge of a valve receiving set has tuned in to one or other of the broadcasting stations and as many as twelve sets of headphones, placed alongside the passengers' arm chairs, have been used.

Aeroplane Engine Tests

In a recent 240 hour endurance test for aeroplane engines of from 350 to 450 h.p., a Renault engine was alone in running continuously for the time prescribed. The contest was for a prize of 1,300,000 francs.

Airship Developments

With the cancellation of further work upon R.36 and the abandonment of R.33's flight to Egypt and India, airship development in Great Britain seems doomed to slow progress for at least two or three years. Of course, considerable interest still centres around R.101, to which, it is stated, seven Beardmore high-speed heavy oil engines of 600 h.p. each are being fitted, but some time must necessarily elapse before this vessel is ready for her trials.

In the meantime the problem of the best gas for the inflation of airships occupies the attention of experts throughout the world. Helium is still regarded as the safest, but the comparative rarity of this gas makes the apparently inevitable wastage a serious matter to overcome. In Germany a system is being investigated whereby an airship is to be made to ascend and descend by heating and cooling the helium by electricity, so that it expands or contracts, thus inflating or deflating the envelope. In some American aviation circles, however, airship designers are very hopeful that the development

of the heavy oil engine will make possible the safe use of hydrogen, which gives a very much greater cruising radius than helium.

Western Australian Airways

In November last Western Australian Airways completed their 200th trip and had then flown a distance equivalent to 24 times round the world.

South African Non-Stop Flight

The South African aviators, Major Meintjes and Lieut. Roos, recently flew a total distance of 1,200 miles in 13½ hours without a stop. The machine was a D.H.9 equipped with a 240 h.p. Puma engine and belonging to the South African Air Force. The object of the flight, which was over a circular course starting and finishing at Pretoria, was to demonstrate that it was possible to reach any part of South Africa in one day if necessary.

New Flying Badge

It has been announced that the King has approved a new flying badge to be worn by officers of the Royal Navy and the Royal Marines when attached to the Royal Air Force for service in the Fleet air arm. The badge consists of a silver anchor and cable of silver embroidery, surmounted by a laurel wreath of silver embroidery superimposed on the wings of an albatross in gold embroidery.

The badge will be worn by Naval officers in the centre of the left sleeve and by officers of the Royal Marines on the left fore-arm and must be worn continuously during the whole period of an officer's attachment to the flying service.

Aerial Postage Train

In our February issue we described the experiment of releasing small aeroplanes from an airship in flight, and we now learn that the method then employed is being experimented with as a means of picking up mails while the parent ship is in flight.

To attain this object long steel ropes carrying a cross-bar are lowered from beneath the airship. The small aeroplanes, equipped with a clip somewhat resembling that used on trains for picking up mail bags, fly close enough to permit the clip to engage with the cross-bar. When the aeroplane is thus anchored, the engine is shut off and the machine hauled up to the parent airship. Experiments on these lines have been carried out very successfully with both airship and aeroplane travelling at a high speed.

New Air Service

German interests are co-operating with Imperial Airways Ltd., in the arrangements recently completed for a service of all-metal air boats carrying passengers, mail and general merchandise between Great Britain and Sweden. The machines to be used will be monoplanes designed by the German constructor Dornier and driven by Rolls-Royce engines. The journey of approximately 700 miles will be made in one day, and the service is to commence in June next, the route being from Gothenburg, down the Kattegat to Kiel, along the Kiel Canal and across the North Sea to Harwich.

World's Air Records

The Federation Aeronautique Internationale, the accepted authority on air records, has recently overhauled its record books. Hitherto it has been possible to create some 1,300 world's air records of varying nature, but with the object of increasing their technical, commercial and moral value, this number has been reduced to 168, all but the most important ones having been eliminated.

The League of Aviators

An International League of Aviators, composed of aeroplane pilots drawn from Great Britain, France, Italy, Belgium and the United States, has been inaugurated in Paris under the auspices of the French Organisation of Pre-war Aviators. The association has for its main aim the preservation of peace in the air and it is anticipated that within two years the membership will be over 30,000.

Sun Worship

The dull spell experienced towards the end of January evidently had had a very depressing effect upon a party of visitors who called at the Croydon Aerodrome on 1st February. They demanded to be taken to see the sun, and a powerful Napier D.H. machine was made ready and the party embarked. During the preparation for the flight it was ascertained from the Meteorological Office that the cloud bank at that moment did not extend upwards from the earth for more than 4,500 feet.

Up and up went the machine until it attained a height of 6,000 ft. where it emerged into brilliant sunshine. The delighted passengers insisted upon the pilot remaining aloft for some little time, and remained basking in the sun. The total bill for the flight amounted to £30, and when this was presented to them upon their arrival back upon the earth the passengers declared it to have been well worth it!

Aerial Camera Developments

We have mentioned recently the importance of aerial photography and in this connection a new aerial survey camera is of interest. This camera is automatic in action and makes 100 exposures on one spool of film without any attention, after the shutter has been set to take photographs at regular intervals of half a mile or at any other desired interval.

All the airman has to do is to pilot his machine in a straight line across country and to maintain the same altitude throughout. Upon reaching the boundary of the area under survey, the machine would be put about and flown back across the same country in a line parallel to the previous route. Throughout this time the camera will make exposures that, when developed, printed and pasted up together will form a mosaic map of the area covered. The maintenance of uniform altitude ensures a uniform scale for the photographs, which are not only accurate from a geographical survey point of view, but also include every road, landmark, building and tree.

Specially prepared films sensitive in an unusual degree to red rays are employed, and with their aid the aerial camera is able to secure perfectly defined photographs even on misty days.

A Remarkable Fighting Machine

A two-seater fighting machine is now being constructed privately, without the supervision of the Air Ministry, by a well-known British firm of aircraft constructors. This machine will be able to climb to an altitude hitherto only attainable by a single-seater scout and will be capable of a speed of 200 miles per hour. The engine is to be one of the new type direct drive Napiers, so that the machine will be all British.

Elaborate precautions are being taken to eliminate all external projections such as bracing wires and struts, and the controls will be carried inside the wings and fuselage structures, thus making the stream line almost perfect. The weights are so grouped that the machine possesses an extraordinary degree of manoeuvrability. In flight it will be able to turn, twist, and dive with such lightning rapidity that the gunner, seated immediately behind the pilot and in such a position that signals will be easily exchangeable, will be placed quickly in a position to bring his machine gun into operation.

Huge Passenger Machines

After this month the passenger services of Imperial Airways Ltd. will be operated almost entirely by multi-engined machines. The fleet will then include, in addition to the huge Vickers Vanguard, four new Handley-Page sixteen seater twin-engine machines, three twin-engine Handley-Page-Rolls-Royce machines, and two three-engined Handley-Pages.

German Aircraft Activities

Preparations are being made by German aircraft constructors to start work on several giant machines, more powerful than any in the world, and already the designs of some huge multi-engined machines have been completed. As our readers are aware, aircraft construction in Germany is limited by clauses in the Treaty of Versailles, but it is anticipated that after

Germany's admission to the League of Nations these restrictions will be relaxed.

A 28-passenger machine is to be built at the Rohrbach factory in Berlin, and the details of this machine afford a clear indication of Germany's aerial ambition. The machine is to be fitted with three engines, each of 400 h.p. These will be American Wright air-cooled radial engines, which were delivered some weeks ago at the works in Berlin. The wing span of the machine is to be 177.17 ft., and it is hoped that trial flights will take place within the next two months.

The Dornier firm are considering the details of a 3,000 h.p. passenger-carrying machine and it is probable that this will be fitted with British engines. A huge four-engined

Dornier flying-boat, similar in certain constructional features to the machine in which Commandant Franco made his flight to Buenos Ayres recently, has been commissioned by the Spanish Government. This machine will have four Napier "Lion" engines giving a total of more than 1,800 h.p.

Factories building machines of German design in Copenhagen, Moscow, and elsewhere are busily engaged on aircraft for foreign governments. The Turkish Government is reported to have ordered fifty single-seater duralumin fighting aeroplanes from the Rohrbach works near Copenhagen. These aeroplanes will have a speed of 186 m.p.h.

Three-engined all-metal Junkers monoplanes for Chile and Russia are being constructed under licence by a Swedish factory.

Relief from the Air

In consequence of reports that some of the crew were on the verge of starvation, aeroplanes carrying bully beef and biscuits were despatched to the relief of three ships locked in the ice in the Gulf of Finland. The provisions were dropped on the ice floes near the ships, several of which have been held up for some months.

Giant Passenger Machine

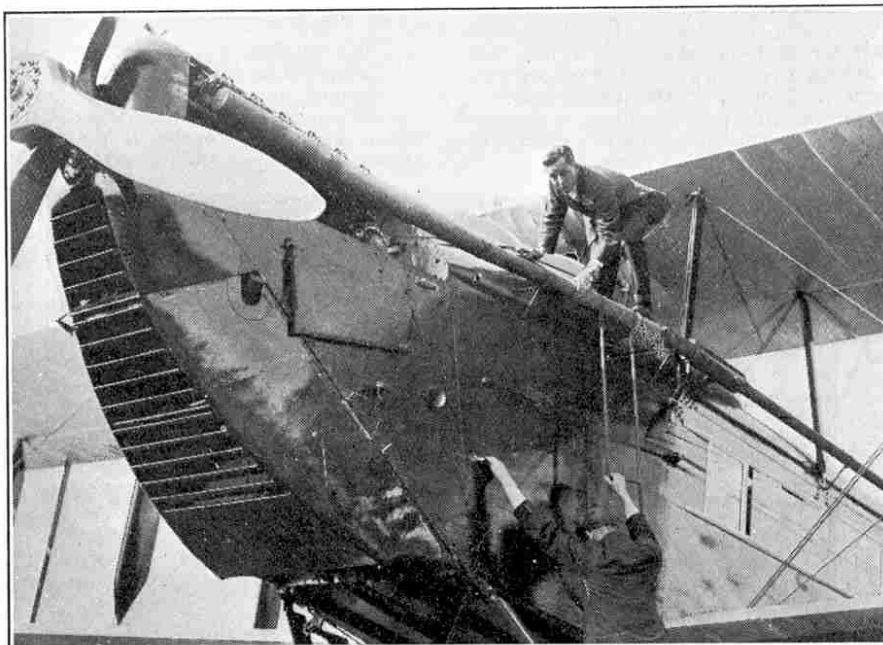

Photo courtesy]

[De Havilland Aircraft Co. Ltd.

Our photograph shows Captain H. S. Broad, test pilot, entering the cockpit of a D.H.54, the largest single-engined commercial aeroplane in the world. This is the De Havilland "Highclere," designed to carry 14 passengers in a luxuriously appointed cabin and fitted with a 650 h.p. Rolls Royce "Condor" engine

Australian Amphibians

A Supermarine Napier-Seagull, was launched at Southampton in February by Lady Cook, wife of the High Commissioner for Australia. This is the first of a batch of six Australian amphibian aeroplanes.

* * * *

New Puma Machine

Secret tests have been carried out recently with a new Puma aeroplane driven by a single Rolls-Royce engine developing more than 700 h.p. The machine is capable of flying with a full load of passengers at 100 miles an hour at an altitude approximating to four miles. At this height the machine will be practically invisible and consequently almost immune from attack by anti-aircraft guns. The speed in the rarified atmosphere existing at such an altitude is phenomenal.

Details are not yet available, but a recent decision of the Air Ministry to replace all existing wood and fabric machines by all-metal 'planes gives a very definite pointer as to the construction of this machine. The change-over to all-metal is to be completed by the end of 1928, but the replacement will only be made as the present machines become obsolete.

Results of Meccano Model-Building Contests

By Frank Hornby

Motor Competition

LAST month I expressed the opinion that aeroplanes, motor-cars, etc., were rapidly increasing in popularity as subjects for Meccano models. The response to the Motor-car Model-building Competition seems to support this belief, for the number of entries received even surpasses the record set up in the Aeroplane Contest. Indeed, if the model-building competitions continue to grow at this rate it will be necessary to augment our staff of judges to a considerable extent, otherwise we shall be terribly over-worked in awarding prizes!

The selection of prize-winners in the Motor Competition proved a difficult task and it was decided to give two prizes of 10/6 each in addition to the six first announced. Also, a tie was declared for the third prize, as it was quite impossible to decide which was the better of the two entries in question. Following last month's practice I am again awarding a number of handsome Certificates of Merit to those competitors whose work closely approached prize-winning standard, while a number of complimentary copies of the "Meccano Standard Mechanisms Manual" will be distributed as consolation prizes.

Results :

After careful consideration the awards in Section "A" (British Isles) have been finally allocated as follows :—

First Prize (cheque for £5-5s.) :

John Russell, 114, Spring Gardens, Abbeyhill, Edinburgh.

Second Prize (cheque for £3-3s.) :

Edward Baker, 1, Victoria Terrace, Frinton-on-Sea, Essex.

Third Prize (a tie, cheque for £1-1s. will be sent to each competitor) :

W. Riley, 126, Dewsbury Road, Ossett, Yorks., and R. A. Webber, 35, Adys Road, London, S.E.15.

Prizes of 10/6 each :

John V. Hudson, 51, Briar Avenue, London, S.W.16; Kenneth Smith, 28, Granville Road, Gravesend, Kent; Q. S. Moore, 21, Park Avenue, Barry, Glam.; R. Stockton, 6a, Khartoum Road, London, S.W.17; Kenneth Brookes, 1, Shaw Place, Leek, Staffs.; Chris. Brimble, 29, Rathbone Road, Bearwood, Birmingham; R. A. Pervanoglu, 78, Wiverton Road, London, S.E.26; R. Michell, Bella Vista, Wilmington, nr. Honiton, Devon.

The following competitors, who are amongst those gaining Certificates of Merit, have been selected as deserving particular mention :

W. S. Clayton, Clondalkin, Ireland; R. Batchellor, Beckenham; J. King, Glasgow; L. White, Bletchley; R. Painter, Manchester; J. Bailey, Maryport; E. Humes, Norwich; P. W. Bedale, Cambridge; H. Jones, Maybole, Ayrshire; L. Harris, Camborne; J. Fletcher, Bingley; R. Holmes, New Mill, R. Huddersfield; Harold Frost, Coventry; L. H. Nash, Uxbridge; A. H. Miles, Leighton Buzzard; J. Paul, Cardenden, Fifeshire; D. Miles, Hall Green, N. Birmingham; E. Strange, Saffron Walden; C. H. Harrison, Blackpool; R. Viney, Manchester; R. McLeod, Kilmarnock; G. Lawson, Seascale; W. T. Vale, Liphook; A. Russell,

Hall Green, Birmingham; F. G. Moody, Wimbledon Park; C. K. Kernahan, Belfast.

The First Prize Winner

The realistic two-seater motor-car that secures first prize is illustrated on this page. It is of the latest and most luxurious design and includes a dickie, luggage carrier, and other refinements of the modern touring car. It is constructed entirely from Meccano parts with the exception of the discs fitted to the road wheels. These are shaped from wood, but, of course, may be dispensed

with if desired. The wheels are fitted with Meccano Rubber Rings and are carried in laminated springs. The steering gear is most realistic and efficient in operation. The front stub axles are journaled in Flange Wheels, which are secured by bolts passing through their upper and lower holes to two Couplings mounted on a vertical 2" Rod secured in the chassis of the car. The stub axle mountings are rocked about this pivot by means of a lever action similar to that described in the Meccano Chassis steering gear (see Meccano Standard Mechanism No. 115). I would draw attention, amongst other points, to the excellent construction of the mudguards and

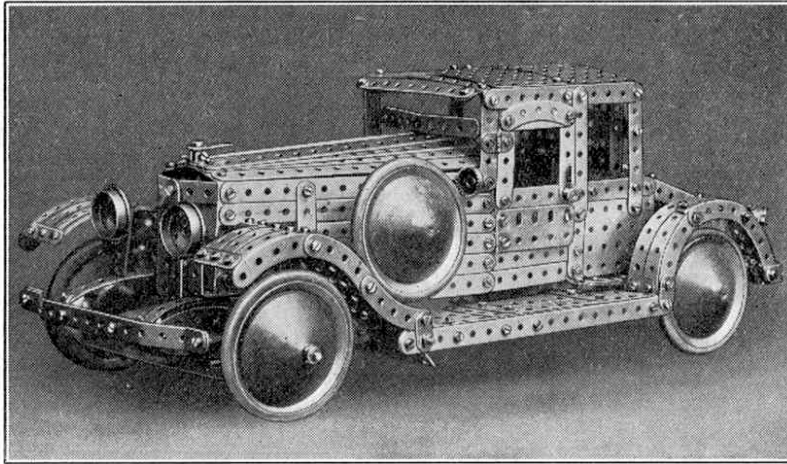

Awarded First Prize : Saloon Coupé, with dicky-seat (John Russell, Edinburgh)

to the door, which is built up from short strips and mounted on Meccano Hinges. Flange Wheels serve as headlights, whilst $\frac{3}{4}$ " Contrate Wheels take the place of side-lamps. Miniature fittings are mounted on the dash-board, and a Spring-Buffer represents a mechanical horn.

A Mechanical Tipper

An excellent model of a commercial tipping-lorry gains the second prize. The lorry is driven by a Clockwork Motor representing the engine, the power being transmitted through a clutch and gear-box, while Sprocket Chains form the final drive to the road wheels.

The clutch consists of two $1\frac{1}{2}$ " Contrate

Wheels, one of which, with set-screw extracted, is secured to a $1\frac{1}{2}$ " Sprocket Wheel, also without a set-screw, by means of $\frac{3}{4}$ " Bolts. The two wheels thus bolted together are slidable upon the shaft leading to the gear-box, and their movement is controlled by a foot pedal. On operation of the latter the sliding Contrate Wheel may be brought in or out of engagement with the second Contrate Wheel, which is secured to the gear-box shaft. The sliding Sprocket Wheel is driven from the engine by chain gear.

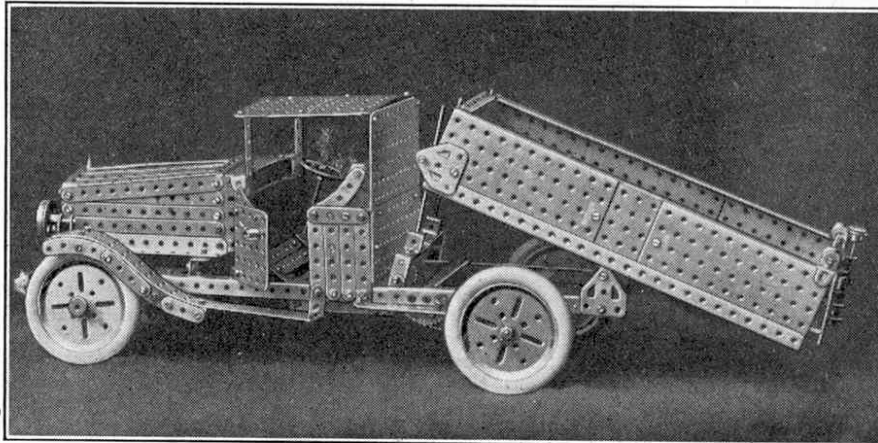

Awarded Second Prize : Commercial Tipping Lorry (Edward Baker, Frinton-on-Sea)

The gear-box contains two speeds forward and a reverse, each of which may be brought into operation by the movement of a lever on the right-hand side of the chassis.

The tipping motion is effected by placing the gears in the neutral position, when one of the 50-teeth Gear Wheels in the gear-box is brought into engagement with a $\frac{3}{4}$ " Pinion beneath the driver's seat. The axle on which the Pinion is secured passes through to the back of the cab and by means of a $\frac{1}{2}$ " Pinion and $\frac{3}{4}$ " Contrate Wheel drives a transverse shaft carrying two Bevel Wheels. These gear with similar wheels secured to two Threaded Rods, which pass through the threaded bores of Couplings pivotally attached to the tipping portion of the lorry. Consequently, the latter is forced slowly up or down as the Threaded Rods rotate.

Tie for Third Prize

Two entries tied for the third prize,

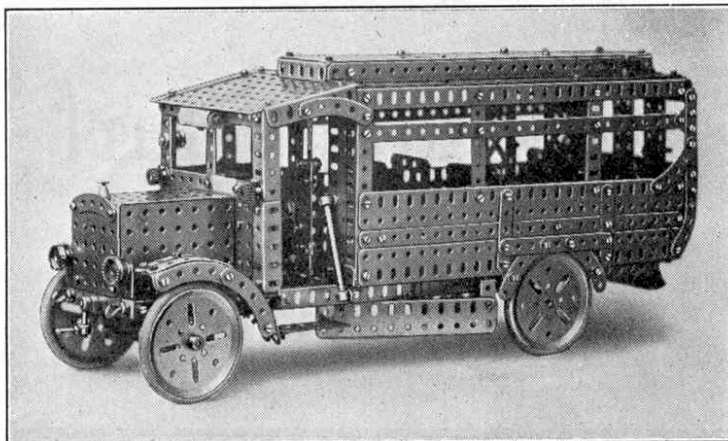

Awarded Third Prize (tie) : Passenger Motor Coach. (W. Riley, Ossett)

Note inner door alongside driver's seat, starting handle, etc.

of the seat and is attached to one of the adjoining 2" Girders by means of a Hinge, in order that it may readily be lifted out of the way to permit of free access to the emergency door.

A passengers' entrance is provided

by another door set into the partition at the rear of the driver's seat. The method by which the doors are fastened should prove interesting, since it may be applied to a number of Meccano models. A Threaded Pin, secured in

one hole of a Flat Bracket, is passed through the Strip forming the outer edge of the door. A Collar, with a second Threaded Pin inserted in the place of its set-screw, is then secured to the first Threaded Pin to form a handle, one or two Washers first being placed between

the Collar and the door. On moving this handle the Flat Bracket is caused to slide behind the jamb of the door, so fastening the latter in position.

A Famous 'Bus

The second motor-bus is modelled from the famous type so familiar in London. It is well built, and appears almost as sturdy and comfortable to ride in as its giant prototype, which, with the help of some 5,000 of the same class, carries every day several millions of passengers a distance equal to a journey completely round the world! The model is fitted with seats both inside and on the top deck. The driver's seat is correctly placed alongside, instead of behind, the engine. Much amusement may be derived from the design of miniature advertisements, destination boards, etc., with which to decorate the 'bus, and such additions will result in a pleasing and most realistic model.

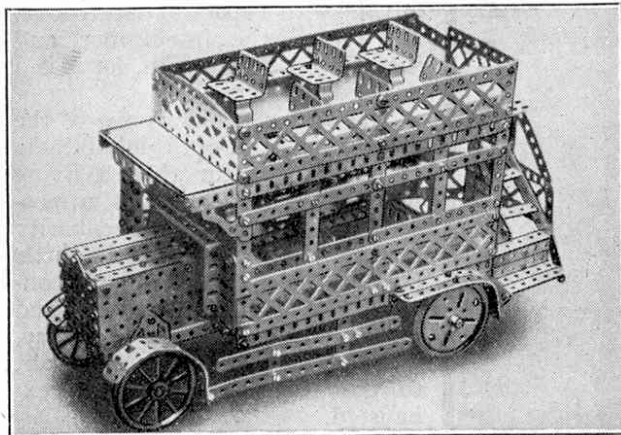

Awarded Third Prize (tie) : Motor 'Bus. (R. Webber, London, S.E.15)

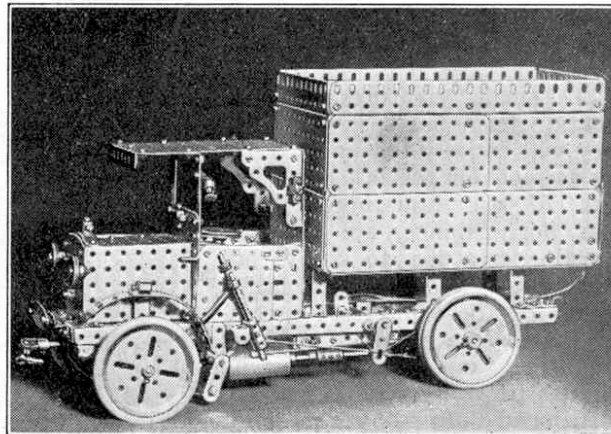

A typical Commercial Motor Van. (G. V. Hudson, London, S.W.16)

both being excellent models of motor-omnibuses. The first is of the single deck type, and is complete down to such details as seats, opening doors, destination plates, etc. An emergency door is fitted at the back of the coach. A step is mounted pivotally upon an Axle Rod secured immediately below this door, and is carried normally in a folded position. It is so held by an Angle Bracket bolted to the door; hence, as soon as the emergency door is opened, the step falls into position ready for use.

A partition separates the rear portion of the remainder for the use of smokers. A seat composed of two 2" and one 1 1/2" Flat Girders placed end to end stretches across the back of the coach. The 1 1/2" Girder is situated in the centre

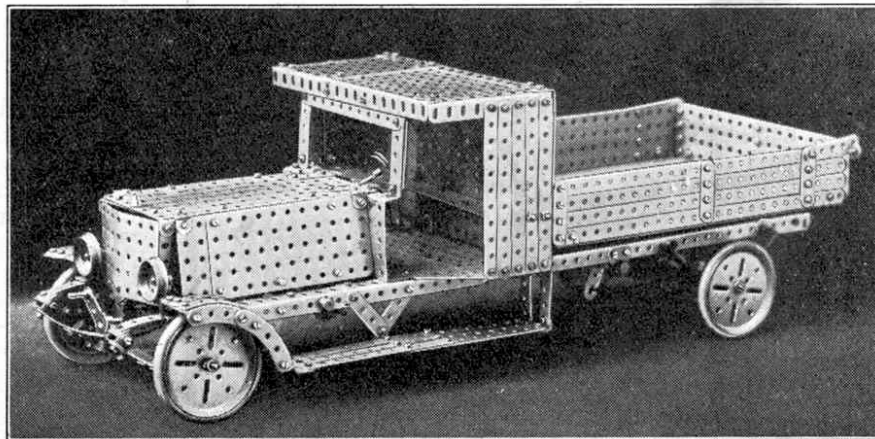

Open Motor Wagon. (R. Michell, Wilmington)

The other prize-winning entries include some very fine specimens of this type of model construction, and the Motor Wagon illustrated is an excellent example.

Kenneth Smith submitted an ingenious model of an oil-tank lorry, the tank of which was constructed from a series of 12 1/2"

Strips bolted to the outer rims of two Hub Discs, while a Motor Fire Escape, built by R. A. Pervanoglu, showed particular merit. R. Stockton entered a reproduction of an L.C.C. refuse lorry, the body of which is mounted on four small wheels. Whilst collecting the refuse this portion is used as a separate unit and is drawn by a horse. As soon as it is filled, however, it is run on to the lorry and so conveyed more expeditiously to the destructor, where its contents are dumped.

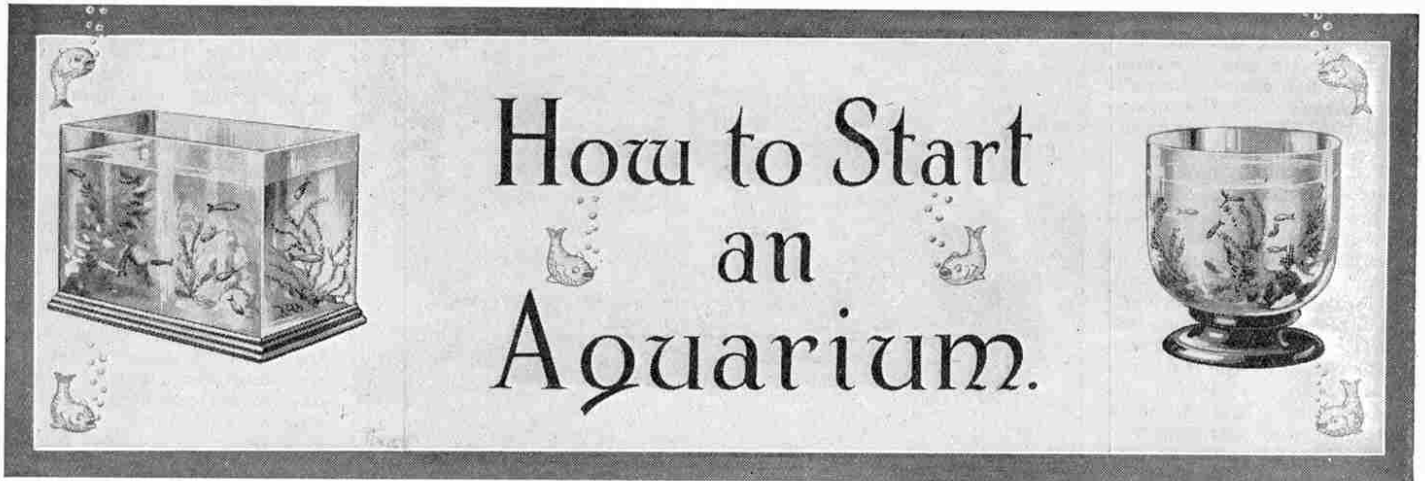

By W. COLES-FINCH
(Resident Engineer, Chatham etc. Water Co.)

It is often supposed that the inhabitants of an aquarium consist solely of fish, but this is by no means the case. In addition to the popular types of fishes there are many small creatures that may well be studied and the keeping of which affords considerable interest.

In some cases it is well to keep these small creatures entirely separate from fishes as otherwise they will entirely disappear, serving as food for the other inhabitants of the aquarium. Water fleas, for instance, are very interesting creatures to study, but as they are a delicacy to fish a colony of these interesting creatures soon disappears if kept in the same tank as hungry fish! Often part of the tank may be partitioned off, however, and special partitions may be arranged for separating the fish and keeping them away from the small creatures that form their food. Perhaps an even better plan is to have a separate tank entirely for these tiny creatures, which tank need not necessarily be an elaborate affair.

A Remarkable Creature

Among the more interesting of these small inhabitants of an aquarium is the Water Spider (*Argyroneta aquatica*), a wonderful creature. The writer has kept these creatures for many years and found no little delight in photographing them in their aqueous home.

They are sometimes known as "Silver Spiders," from the manner in which their bodies are made to resemble burnished silver by the atmospheric air bubbles that become entangled in the fine hairs.

The Water Spider should have a vessel entirely to itself, prepared

as described in previous articles in the matter of plant life, in which it can live without fear or interference by other creatures. Living in these peaceful conditions it will readily construct its beautiful nest, a task that will fascinate anyone with a spark of nature love, and prove the intelligence and ingenuity of the artisan, for it is a dexterous creature.

The Water Spider is one of the most remarkable of the inhabitants of our ponds, for though living under water it breathes atmospheric air. In this peculiarity lies all the wonder of the little creature's working, for it constructs its home under water and inflates it and, when necessary, recharges it with atmospheric air, so that this never becomes exhausted.

The Spider's Wonderful "House"

The spiders shown in the accompanying photographs were obtained from Cambridge, but any dealer will obtain specimens to order.

When first installed they took up comfortable quarters under a floating patch of Willow Moss (*Fontinalis antipyretica*) which, as the photographs show was heavily covered with beads of oxygen. There they put in most of their time, merely running a few confused straggling threads leading to the pebbles on the bottom of the tank, these being the preliminaries of the framework of their building.

The *Argyroneta* is a large spider. Its abdomen is olive colour, and the rest, including the legs, is of a dark reddish-brown. Unlike the "Garden" and other spiders, the male is the larger. While the house spider constructs the floor of its web of such fineness that it will support water, the *Argyroneta*



Water Spider looking for a site for her nest

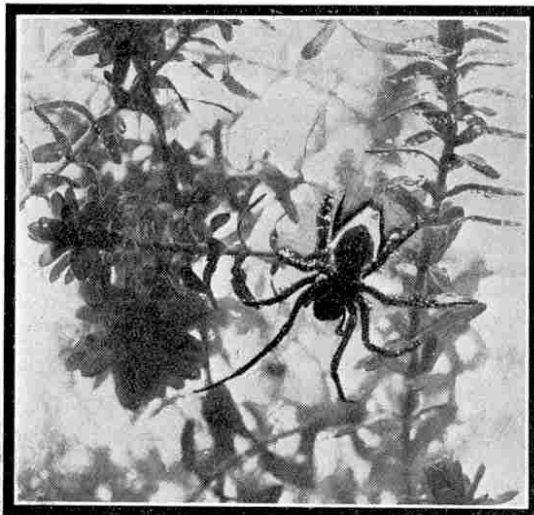

Water Spider diving with air bubbles. Note beads of oxygen on spider's legs and also on the Canadian water weed

constructs a web under water of such fineness that it will imprison air! Thus the "Diving Water Spider" is rather amphibious than aquatic, although it spends most of its time under water.

Now as to its marvellous house! The spider weaves its silken cell between the branches of some aquatic plant, or anchors it to any object that may suit its purpose. The house is usually entirely submerged, sometimes near the surface, sometimes near the bottom of the tank. It is beautifully transparent and oval in shape, resembling in size half the shell of a pigeon's egg, with the opening or entrance downward in the fashion of the ancient "Diving Bell."

Charging the Nest with Air

Before the spider can occupy her transparent chamber comfortably it must be filled with air, and the manner in which this is accomplished is both wonderful and interesting. As the spider rises to the surface of the water, she turns the extremity of the abdomen upwards, and by a sharp snap of the hind legs obtains a bubble of air, which is automatically entangled in the hairy covering of the body. Holding the bubble by the two hind legs, which are crossed at an acute angle near the extremity, she descends quickly and releases the air at the entrance of the chamber.

By repeated efforts of this kind the spider fills the chamber, and by sundry internal smoothings and pressings of the silken dome, to get it into shape, all the water is at last displaced by the air and a chamber having the appearance of a transparent globe of burnished silver is the result. Some 14 journeys are necessary to complete the inflation.

In this subaqueous dwelling *Argyroneta* lives. It is here she devours her prey and lays her eggs, spinning a white silken cocoon at the top of the dome for them. Here her young, about 100 in number, appear in about a fortnight, and remain for a few days.

Almost directly they leave the nest in which they have been born the young begin to construct small homes of web and air for themselves.

It is interesting to note that the male as well as the female constructs such cells, and during the summer no less than the winter.

Feeding the Spiders

Dr. Bateman states:—"In one of these subaqueous homes the *Argyroneta* spends the greater part of the winter. I have had several spiders that have remained in their nests under water for three or four months, without either moving or taking food. When the female wishes to lay her eggs, she either enlarges her old nest or builds an entirely new one. . . . The male spider often makes a new nest for himself near to the one his lady-love has constructed or enlarged for her eggs."

These spiders do not like stagnant water and owing to their sadly depleted numbers they are now difficult to find in many ponds where once they were common. Any reliable dealer will supply them, however.

As regards feeding, the best method is to stock the tank with water-lice and other small creatures from the pond and leave the spiders to fend for themselves. Hunger should be avoided, as when hungry the spiders have decidedly cannibalistic habits!

Unfortunately we must pass over many points of interest concerning the *Argyroneta*. A note of the death of my favourite may interest the reader, however, as her picture appears in the accompanying illustrations. Before taking my annual holiday I saw that the tank

was in a healthy condition and that the plants were thriving and giving off oxygen freely. The larder was replenished with water-lice, which the spider dearly loves. I foolishly thought that she would take one or two daily to appease her appetite, searching for them among the plants and stones. I was mistaken!

On arriving home I found her resting on a plant in quite a natural way, but she was very thin. I also noticed that the silvery bubble had disappeared from the abdomen, but I still thought that she was merely hungry. I shook the vessel to make her move, when, to my surprise and dismay, her form collapsed and body and legs parted, all falling separately to

the bottom of the vessel! I emptied the tank, and search then showed that not a single insect was left. She had probably devoured the whole lot during the first few days, having more than was good for her, and later had starved for want of food.

Spiders are not Insects

I should like to take this opportunity of reminding readers of the "M.M." that spiders are not insects, although they are very often classed as such by those who do not know any better. They belong to the *Arachnida* and are a well defined group of a great branch of the animal kingdom. As a matter of fact, they were at one time classed as insects by Linnaeus, but were separated into a distinct class by Lamarck. This class is noteworthy as having an external skeleton, the different parts of which are jointed together in a wonderful manner. They have not a brain in the same sense that the vertebrate animals have, but their nervous system springs from enlargements, or knots, called *ganglia*. It is therefore not incorrect to say that these creatures have a number of brains scattered over their tiny bodies. In this respect they resemble bees and wasps. A wasp will not necessarily die even when cut in two, because its *ganglia*, or "local brains," continue to act for a short time, whereas in vertebrates and in man, death occurs immediately should the head be severed from the body.

Spiders form very interesting pets and may be kept for a long time in confinement if they are fed with flies, or other suitable food. The Water Spider, described above, is not the least interesting of this great family, and perhaps the next in order of popularity is the beautifully-marked Garden Spider, the spinner of those wonderful "cart-wheel" webs that present such a magnificent spectacle in the early morning when covered with dew.



The spider in her nest beneath the water. (Note egg of newt on leaf of water-weed on the left)



GOLD-WASHING
IN BRITISH COLUMBIA

The Story of Metals

VIII GOLD.

LAST month we described some of the treacheries and deeds of violence brought about in bygone days by the lure of gold. This month we shall see how the fatal fascination of this metal has produced almost incredible scenes from time to time in the madness of a "gold rush."

In whatever part of the world a gold rush has occurred, the main features have always been the same—first, the announcement that gold has been found in large quantities in a certain region; then the wild stampede of men of all ages and occupations and from all parts of the world. In every case a small proportion of the physically stronger or more fortunate men have reached the goldfield quickly and made fortunes in various degrees, while thousands have either broken down or died on the way and never reached the gold field at all, or after desperate struggles have reached their destination, only to find that they were too late.

A Typical Gold Rush

A typical gold rush occurred in Upper California in 1848. Early in that year the owner of a saw mill situated on a tributary on the Sacramento River was walking along the bank of the stream when he noticed something glittering at a point where the bank was crumbling away. At first he took no notice, but later, after he had come across other glittering objects, he stooped down and picked one up and found it to be gold. He at once informed a friend and the two decided to keep the discovery secret and in the meantime to investigate further. They examined the stream in both directions and soon collected an appreciable quantity of

gold. Their movements did not pass unobserved, however, and soon the secret was out.

It was not long before a labourer who had collected some twenty ounces of gold arrived with his treasure at San Francisco and immediately the town went mad. Labourers, shop-keepers, clerks and professional men of all kinds were seized with the gold fever, and rushed off either alone or in small parties to the diggings. The news of the gold find spread rapidly and large numbers of gold seekers began to arrive at San Francisco by sea. Comparatively few of the new arrivals could afford to pay the extortionate prices charged for even the most miserable lodging, and the remainder encamped on the beach, which rapidly became a slum of the worst type. No sanitary arrangements of any kind were made and sickness quickly broke out, while the only semblance of law and order was that enforced by individuals at the point of the revolver.

Terrible Conditions

The journey from San Francisco to the goldfield occupied many days and fatigue and thirst exacted a heavy toll among the travellers. Matters were made worse by the Indians, who constantly swept down at night to steal horses or anything else of value. On arrival at the mines the gold seekers found the conditions about as bad as they could be. The miserable tents in which they lived afforded little shelter from heat and heavy rain, and the crowding together of many nationalities resulted in continual race quarrels and a good deal of serious fighting, in which revolvers, knives and other weapons were freely used. Disease of all

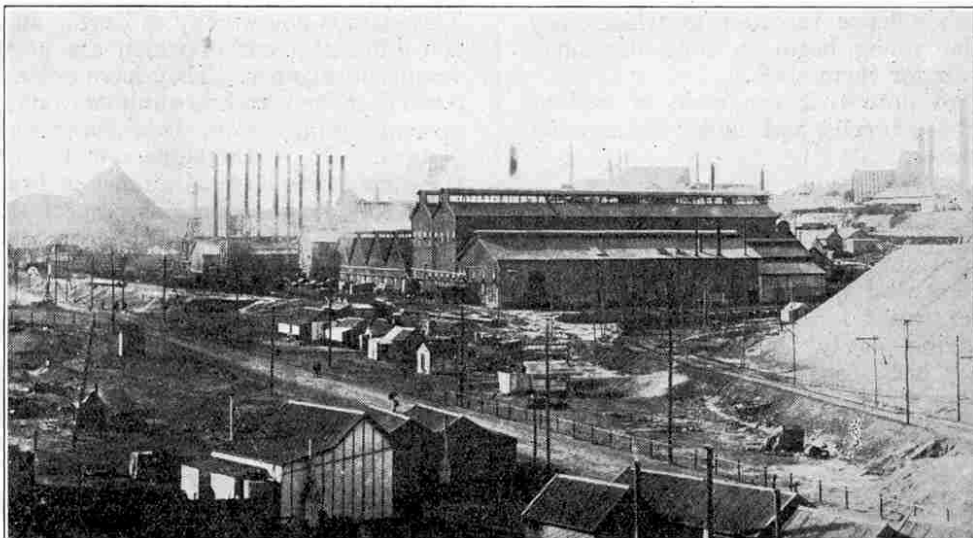

Photo courtesy]

[High Commissioner of Australia

Golden Mile, Kalgoorlie, West Australia

kinds broke out and the sick suffered terribly because they were utterly neglected, their healthy companions being too much imbued with the gold fever to attend to them. There is no doubt that scores died from starvation.

Many of those who reached the diggings in the early days of the rush made large fortunes, but thousands of others, after working desperately hard day after day, found that their small find of gold was little more than sufficient to pay for their daily requirements, the cost of living being so high. Provisions and stores and implements of all kinds were sold at twenty or thirty times their normal price and many of the store-keepers amassed quite large fortunes.

The rush lasted some five years and it is estimated that at its height the miners numbered close upon 100,000. Gradually the gold at or near the surface became exhausted and the gold seekers decreased rapidly in numbers, leaving behind a small proportion of more serious miners provided with the necessary equipment to continue operations at greater depths.

The Klondike Rush

A more recent and even more remarkable gold rush was that to the Klondike in 1897. In the previous year a miner, who had been prospecting without luck for many years, came across gold in remarkable quantities on the banks of the Bonanza Creek and promptly registered his claim

at the mining town of Forty-Mile. The news spread in the wild-fire manner that is characteristic of a gold find, and practically the whole of the inhabitants of Forty-Mile set out for the goldfield. These earliest arrivals made large fortunes in a very short time and the wisest of them got safely away with their gold by steamer to San Francisco.

Then the rush began, and from all parts of the world men of all ages left their occupations and set out for the Klondike. Most of these adventurers had little idea of the appalling difficulties of the journey and large numbers of them started off with pitifully inadequate equipment. The easiest route was by steamer up the Yukon River, but this was also the longest route and consequently those who had the gold fever most acutely took the overland route, which involved crossing either the Chilkoot Pass or the White Pass.

Of these passes the former was the worse. Mr. Harry de Windt, writing in the "*Strand Magazine*" towards the close of 1897, said: "I have roughed it for the past 15 years in Siberia, in Borneo, and in Chinese Tartary, but I can safely describe that climb over the Chilkoot as the severest physical experience of my life."

A Graphic Description

The White Pass was less difficult to negotiate, but nevertheless it proved disastrous to many of those who attempted it. Mr. A. Heilprin, who crossed this pass in 1898, gives the following description in his book "*Alaska and the Klondike*."

"The desert of Sahara, with its lines of skeletons, can boast of no such exhibition of carcasses. Long before Bennet was reached, I had taken count of more than a thousand unfortunates (horses) whose bodies now made part of the trail; frequently we were obliged to pass directly over these ghastly figures of hide, and sometimes, indeed, broke into them. Men whose veracity need not be questioned assured me that what I saw was in no way the full picture of the 'life' of the trail; the carcasses of that time were less than one-third of the full number which in April and May gave grim character to the route to the new Eldorado. Equally spread out, this number would mean one dead animal for every sixty feet of distance!

"The poor beasts succumbed not so

much to the hardships of the trail as to lack of care and the inhuman treatment they received at the hands of their owners. Once out of the line of the mad rush, perhaps unable to extricate themselves from the holding meshes of soft snow and of quagmires, they were allowed to remain where they were, a food offering to the army of carrion eaters which were hovering about, only too certain of the meal being prepared for them. Oftentimes, pack-saddles, and sometimes even the packs, were allowed to remain with the struggling or sunken animal—such was the mad race that the greed of gold inspires."

Control of the Goldfield

It was not long before the towns of Dawson and Klondike, which began as small groups of huts, became

(Continued on page 246)



Photo courtesy]

[High Commissioner of Australia

The Prospector

The Commercial Side of Engineering

And the Training Necessary to Succeed

By a Managing Director

[The following article, which is reprinted from "Engineering," by permission of the Editors, will without doubt interest many of our readers and probably help some of them in the choice of a career.—EDITOR.]

ONE frequently hears of the difficulty experienced by youths in finding remunerative employment as engineers. This difficulty undoubtedly exists in many branches of the trade (or profession), but I am of the opinion that there is one branch, and an attractive one too, which is commonly overlooked—I refer to the commercial side of engineering.

I speak as one who has been trained in works, a technical school, and a university, and, after gaining a wide practical experience, I am now the managing director of a large and important firm of engineers.

Good Prospects for Suitable Men

The branch to which I refer is that of commercial representative in home and foreign countries, and there appears to be a real difficulty in getting hold of suitable men to fill such posts even when good remuneration is offered. The lack of supply of such men is, I think, due to the fact that youths are not alive to the existence of such openings and consequently do not get the proper training to fit them for posts of this description. It may, therefore, be of help to some, if I outline the course of training which, in my opinion, will best fit them for such openings.

Practical Training Required

The type of youth required for this branch should be of good physique, smart in appearance, of good character, fond of outdoor sports, and sensible.

After a good general education he should go into some engineering works when about 16 years of age, where he will work exactly the same hours, and under the same conditions as the other regular employees. The firm will see to it that he gets shifted to various departments, and also to outside erection work, as they think desirable.

For two or three evenings a week from 16 to 21 years of age, he should attend evening classes bearing on his future work.

Must Not be Afraid of "Dirty Work!"

It may be well at this stage to state that I do not consider youths who have been through a course of training at a technical school or university as suitable for the positions I have in view, mainly because they are too old to start on practical work in the shops after their technical training, and, moreover, if they have done what their teachers at college term "well," they nearly always get swelled heads, which unfits them for what they regard as "dirty" menial work in the shops.

The commercial man, in my opinion, does not require an advanced technical training, but it is absolutely essential that he should be well up in the details of the plant and wares turned out by his firm. He must also be able to talk intelligently to clients about the plant for which he wishes to get orders.

Drawing and Commercial Office Training

At about 20 or 21 years of age, the youth should go into the Drawing Office for at least a year. This is not with a view to his becoming an expert draughtsman, but to enable him to follow drawings and to get out general arrangements, in view of the probability of his having in the future to send home such schemes to his firm for them to base their estimates and tenders upon. In general, the details of such schemes will be got out by a draughtsman sent from headquarters.

Another year or so should be spent in the commercial office of the firm, where he will get an insight into costing, ordering materials, office practice, book-keeping, &c. This will bring him to about 23 years of age, when he will be qualified to go as an assistant to one of the firm's representatives.

Story of Metals—(continued from page 245)

towns of considerable size, complete with newspapers, theatres and banks. In this respect the goldfield presented a great contrast to the state of affairs in the California rush of 1848. Another great contrast lay in the fact that there was comparatively little danger to life or property on account of the iron rule of the North-West Mounted Police. This splendidly organised force kept the goldfield free from men whose records were known to be bad, and maintained law and order with such efficiency that serious crime of any kind was comparatively rare.

As was the case with the diggings of Upper California, the surface gold of the Klondike was quickly exhausted, and presently the goldfield was left in possession of those who were prepared to develop it on scientific lines. The days of quickly-made fortunes are over in this region but an enormous amount of gold still remains below the surface—probably far exceeding the quantity already taken out.

Scenes in Australia

Remarkable gold rushes have occurred also in Australia. In 1850 a prospector named Hargraves who, along with many other Australians, had emigrated to California in search of gold, was struck with certain similarities between the gold-bearing regions there and certain districts in New South Wales. He returned to Australia and in the following year discovered gold near Bathurst. Immediately the discovery was announced the usual scenes took place and a large proportion of the population of Sydney rushed to the goldfield. Shortly afterwards gold was discovered at Ballarat in Victoria, and the gold fever promptly attacked Melbourne and Geelong.

As news of the goldfield spread, prospectors from all parts of Australia, and also from China and even Europe, began to arrive in large numbers, and the treasure hunt was carried on at fever heat. A feature of this Australian goldfield was the discovery from time to time of quite large

Remuneration on the Commercial Side

No premium will be asked from youths undergoing such a training, and the remuneration up to 21 years of age would be the standard weekly rates of pay for the district. After that he would receive increases until he went out as an assistant to one of the firm's representatives at a starting salary of about £150 per annum. His prospects would be anything up to £1,000 per annum, or more according to his success.

The firm I represent would be glad to meet with two or three youths who are willing to undergo such a course, and doubtless there are many other firms in the country in the same position as ourselves at the present time and there are likely to be more in the future.

nuggets and the finding of each of these produced a fresh wave of excitement.

Many of these nuggets were of quite extraordinary size and in a future issue we hope to give some particulars of the most famous of them.

Since that period many other enormously rich goldfields have been discovered in various parts of Australia, among which the Coolgardie fields, situated about 350 miles east of Perth, are specially famous. These goldfields presented a serious problem on account of the shortage of water, but the Government tackled the problem and solved it by conveying water by pipe lines from springs in the Darling Range—a distance of some 350 miles!

NEXT MONTH—

The World's Greatest Goldfield

Towers of Mystery—(contd. from page 221)

joining the engine room is a machine shop, completely furnished with lathes and tools. On the deck above is an electrically-equipped kitchen and laundry, ice-plant with refrigerator and cold storage, together with extensive living rooms for the "crew" and storage room for emergency ammunition and food. All the rooms are mechanically ventilated and lighted day and night by electricity.

The deck above the water-line carries recreation rooms and sleeping quarters while above this are two turrets, fore and aft, on the main deck which mount 14 in. naval guns. There are also four 6 in. guns in smaller turrets, two on each side. A battleship mast of the girder type serves as a look out, range finder and wireless aerial.

Altogether, therefore, this huge "stone-battleship" forms a very formidable defence for the harbour and one that could withstand a long siege, being entirely self-contained, with considerable storage room for provisions and ample accommodation for the crew.

Books to Read

Readers frequently write to me asking if I can recommend books that are both of interest and of use. On this page I review books that specially appeal to Meccano boys. I do not actually supply these books, which may be obtained either through any bookseller or direct from the publishers.—EDITOR.

"The Aquarium Book"

By E. G. Boulenger

(Published by Duckworth & Co. Price 10/6)

In this book Mr. Boulenger, who is the director of the Aquarium at the Zoo, tells many entertaining stories of his charges and also deals with the many problems that arise out of the management of an aquarium. He gives a very complete account of the life-history of the inhabitants of ponds, rivers, and oceans that are kept in captivity at the Zoo, and the book will be found of considerable interest to all and especially to those who keep an aquarium of any kind—large or small, sea-water or fresh-water.

It is interesting to find that the Romans kept fish on a grand scale and spent enormous sums on the construction of their fish ponds. Even earlier than this the Chinese kept fish and produced many fancy breeds, the descendants of which delight us to this day. Every monastery and castle had a fish-pond in mediæval times, but in these cases the fish were kept for the table, rather than to be looked at and admired.

Mr. Boulenger deals not only with fish—he has a good deal to say about other inhabitants of an aquarium and even the tiny fresh-water Sponges, Hydra, Waterfleas, Cyclops, and other similar creatures are not omitted. The book is illustrated with a number of drawings and some beautiful photographs, and we feel sure that all our readers who are interested in the subject will find it a mine of information.

The Empire Cruise

By V. C. Scott O'Connor

(Riddle, Smith & Duffus. 16/- net)

In this volume of 300 pages Mr. Scott O'Connor relates in a graphic manner the story of a voyage around the British Empire with the special service squadron of the Royal Navy. This squadron consisted of the two great modern battle cruisers "Hood" and "Repulse" and the light cruisers "Delhi," "Dauntless," "Danae" and "Dragon."

Early in the morning of the 29th November 1923 these ships left their moorings at Devonport and Spithead for a

cruise of the Empire's ports. Before they returned, 10 months later, they had covered over 41,000 miles and had crossed the equator six times. In the course of their voyage they showed the White Ensign to the British Dominions and Colonies in West, South and East Africa, in Ceylon, Malaya, Australia, New Zealand and Canada and to many other places, including the South American Republics, the wonderful Hawaiian Islands and the Pacific Coast of the United States, the

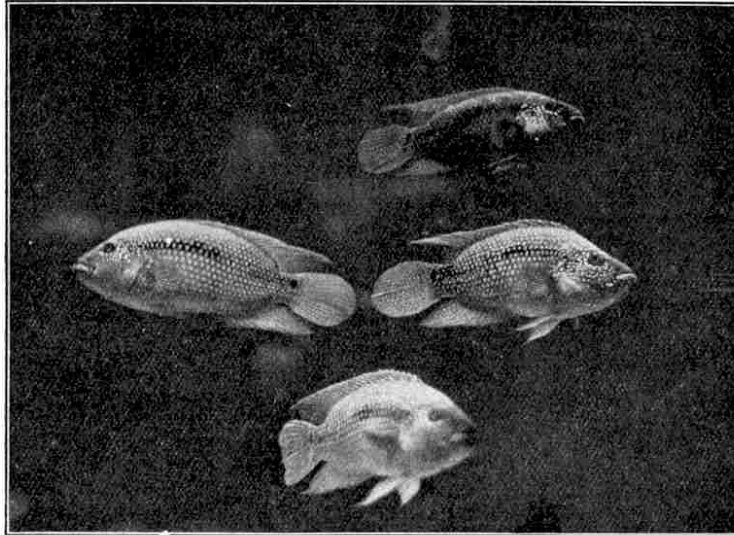

Cichlid Perch—one of the illustrations in "The Aquarium Book" reviewed on this page

scene of many romantic adventures and thrilling exploits in the past.

The life of a squadron at sea is vividly described and we find that pleasure is not, as on a passenger liner, the main occupation of the Fleet even when on an Empire Cruise. It is very evident, too, that the routine of ceaseless preparation for sterner things, picturesque and interesting as it may be to the onlooker, involves much hard work. The description of the author's personal impressions of 16,000 miles of travel by land is written in a spirit and in language worthy of its theme. The variety and immense possibilities of the British Dominions are clearly demonstrated but one realises that underlying everything is the ceaseless and unflagging vigil of our Navy, without which the whole Imperial scheme would collapse.

Those of our readers who like a story of travel and of the sea will find the book of great interest. The illustrations, of which there are 65, many in colour, are excellent, and greatly add to the value of the book.

"E. T. Busk: A Pioneer in Flight"

By His Mother

(Published by J. Murray. Price 7/6)

Edward Busk, an engineer of great promise, was for two years attached to the Royal Aircraft Factory at Farnborough. Both he and his brother H. A. Busk were killed during the War, and this book has been written by his mother to place on record the early work of the brothers in connection with the conquest of the air.

Edward was educated at Harrow and Cambridge and liked to spend his holidays in the Lake District, where he had many interesting adventures. His early experience in climbing gave him an appetite for further adventures in the Alps and in Norway. Later, he joined the staff of the National Physical Laboratory and then went to the Royal Aircraft Establishment at Farnborough, where he was instrumental in designing the inherently stable aeroplane, B.E.2 C. Here, in his 28th year, he met his death whilst carrying out tests in connection with the development of a stable aeroplane. During one of his flights to obtain first hand information he climbed to about 1,000 ft., when his aeroplane suddenly burst into flames and crashed.

Edward Busk was undoubtedly a genius in aeronautics and in the practical application of theory to flight. His brother, who joined the Royal Naval Air Service in January 1914, rose to the rank of Flight Commander and was killed on a bombing raid at Imbros. Readers interested in the early days of aviation will find the book of particular interest, and the brothers undoubtedly have claim to be included in the pioneers of flight, along with the many others who lost their lives in their attempt to contribute to the conquest of the air.

Railway Marvels

By C. J. Allen

(J. P. Shaw & Co. 2/6)

This book, profusely illustrated and dealing with every conceivable branch of railway engineering in a most interesting manner, will make a very strong appeal to our younger readers.

A very attractive coloured cover depicts one of the L.N.E.R. expresses leaving King's Cross. In the 96 pages there are no less than 111 illustrations and 7 coloured plates.

Ancient and modern engines, bridges and viaducts, the use of snow-ploughs in America and Switzerland, the actual work of the engine-driver and fireman, the story of the Canadian Pacific Railway, Miniature Railways, Railway Bridges that swing open, World-famous express trains each have a chapter devoted to them. It is certainly one of the finest Railway Books for younger boys that we have seen for a long time.

No. 2 Outfit Competition Results

Judging from the results of the "Outfit" model-building competitions our readers appear to possess an inexhaustible supply of new and ingenious ideas. I am taking a particularly keen interest in these competitions, for they are revealing several novel and fascinating aspects of Meccano construction, and I shall continue to illustrate each month in the Magazine as many of the prize-winning models as space will allow. The number of entries received in the competitions for Outfits Nos. 1 and 2 actually exceeds the fine record established by the "No. 0" contest, although the majority is not very great.

The results of Sections A and B in the No. 2 Outfit Competition are as follows:—

Section A (boys under 12):

1st Prize (Meccano Products to value of £2-2s.): W. S. Elliott, 182, St. Paul's Road, Peterborough (Clothes-Washing Machine). 2nd Prize (Meccano Products to value of £1-1s.): Anthony Messenger, 5, Priestfield Avenue, Rochester (Windmill Pump). 3rd Prize (Meccano Products to value of 10/6): Edward Cain, 63, Strand Street, Douglas, I.O.M. (Mill Engine).

Section B (Boys over 12 and under 16):

Prizes similar to those in Section A. First Prize: N. S. W. & J. Wheatley, "Bengarth," Hare Lane, Claygate (Derrick). Second Prize: J. J. McManus, Bridge End, Derry, Ireland (Drop Hammer). Third Prize: George E. Owen, 148, Henleaze Road, Bristol (Tram Car).

In accordance with the plan announced last month I am again presenting a number of complimentary copies of the "Standard Mechanisms Manual" to those competitors whose work shows outstanding qualities, whilst a limited number of Certificates of Merit will be awarded to the boys whose entries closely approach prize-winning standard. Amongst the competitors who gain the Certificates this month the following have been specially commended by the judges:—

Section A:

Hilda M. Clayton, Clondalkin, Co. Dublin; W. R. Withers, Chester; Raymond Emery, London, W.7; F. Hanson, Portsmouth; R. T. Stokes, Birmingham; Noel Gibson, Broadstairs.

Section B:

James Brown, Grangemouth, Scotland; J. Cattaway, Westcliff-on-Sea; C. N. Beattie, Lewes; Spencer Reed, Bridgewater; H. Taffs, London, S.E.18; E. Body, Liverpool; R. Penrose, Plymouth; Eric Copley, Brighouse; A. Macleod, Leith; R. Smith, London, S.E.14; Diana Meek, Bisley, Glos.

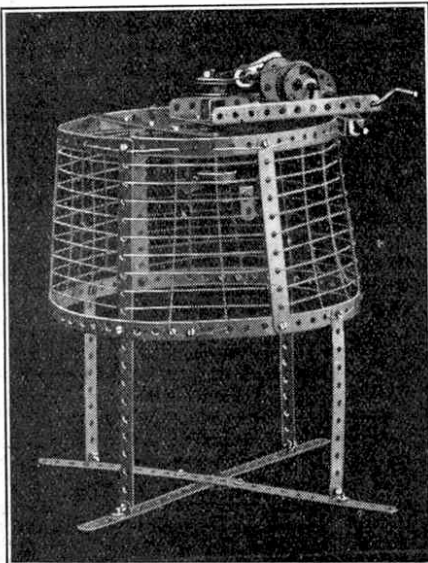

Clothes-Washing Machine, by W. S. Elliott (Awarded First Prize in Section A)

A New Meccano Derrick

The first prize in Section B has been awarded jointly to two brothers whose combined work has produced an interesting model of a builder's derrick. The upright column in this model is mounted pivotally

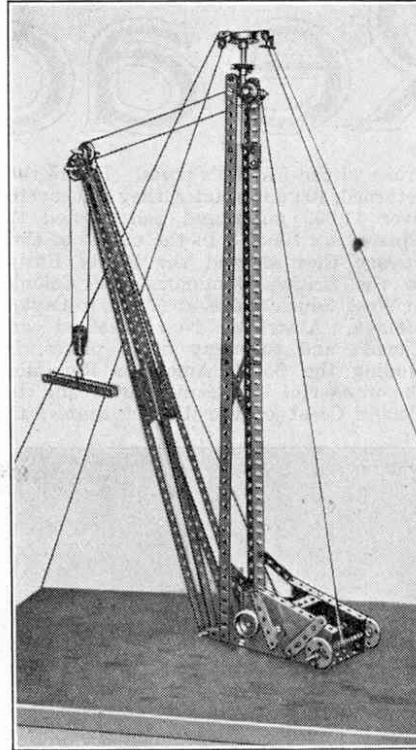

Derrick, by N. S. W. & J. Wheatley (Awarded First Prize in Section B)

upon a wooden base, and its top extremity swivels about an Axle Rod secured in a Flange Wheel. Two $2\frac{1}{2}'' \times \frac{1}{2}''$ Double Angle Strips are placed upon the axle and cords (representing the hawsers used in actual practice) tied to their ends are led down and secured one to each corner of the wooden base. The jib is built up from $12\frac{1}{2}''$ Strips, and is pivoted to the base of the crane. Its head is formed from two Flat Trunnions bolted by their centre holes to a Double Bracket secured in the end of the jib.

The luffing movement is controlled from a shaft carried in the ends of the Sector Plates forming the gear box, the operating cord being led over a 1" Pulley with set screw carried at the top of the upright column, and thence round a 1" Pulley in the jib-head, the cord finally being tied to the upright Angle Girders. The load is raised or lowered by means of a Crank Handle journaled in the gear box. The cord in this case passes over the Axle Rod which carries the 1" loose Pulley at the jib-head, and over a 1" Pulley with set screw as shown. It is then led round the Pulley attached to the load-hook and secured to the jib.

Friction brakes control the winding gear. These consist of two $2\frac{1}{2}''$ Strips bolted to Cranks carried on Rods journaled in the gear box. A piece of elastic is tied to the lower ends of the Strips, thus causing them to exert a continual pressure upon two Flange Wheels, secured one to each of the two operating shafts.

Clothes-Washing Machine

A very original model of a clothes-washing machine secures first prize in Section A. The revolving arms in the centre of the tub in this model are constructed from a series of Flat Brackets and Angle Brackets secured to a Flange Wheel mounted on a vertical shaft. This shaft is driven by means of cord passing round 1" Pulleys on its upper end and round Flange Wheels secured to a transverse Rod. The latter carries at one end a Crank connected by bolts and lock nuts to a $2\frac{1}{2}''$ Strip; this in turn is similarly attached to a $\frac{1}{2}''$ reversed Angle Bracket bolted to a Bush Wheel on the operating handle. On rotation of the latter, therefore, the vertical spindle in the centre of the tub is caused to rotate first in one direction and then the other, owing to the fact that, while the Bush Wheel describes complete revolutions, the Crank on the secondary shaft is merely pushed to and fro and not in a complete circle. The central vertical spindle, together with the secondary shaft, etc., are mounted in a Flanged Plate pivotally secured to the side of the tub. In this way the mechanism may be lifted clear of the tub when it is required to remove the contents of same.

Pump Operated by Wind Power

Another illustration reproduced on this page shows the second prize-winner in Section A. This is a neat model of a pump, designed for operation by wind power. A strip of thin cardboard is laced with string to the circumference of a wheel formed from $5\frac{1}{2}''$ Strips bent in circular form. Twenty-four vanes, fashioned from similar material, are then attached, each vane having a slit cut in it which fits over the circular piece of cardboard. The inner ends of the vanes are laced together by a piece of cord.

The power derived from the rotation of the wheel is converted to a reciprocating motion and transmitted to the pump, situated in the base of the model, by means of a crank, secured to the driving shaft, and connecting-rod.

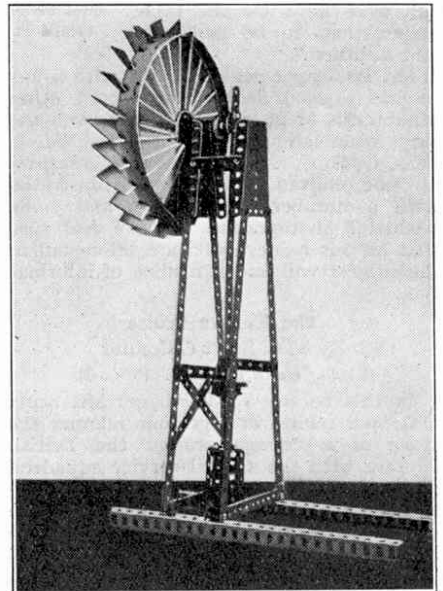

Wind-driven Pump, by A. Messenger (Awarded Second Prize in Section A)

Overseas Model-Building Competition Results

I am able now to announce the results of the first two Overseas Model-Building Competitions of the series. These monthly contests appear to be almost equally popular abroad as they are at home, and a very large number of entries, originating from all parts of the world, was received in the "O Outfit" and "Loco" Competitions, both of which closed on 27th February. A high standard of excellence was noticeable in the majority of the entries, and the final allotment of prizes proved to be a difficult task.

Overseas Loco Contest

First Prize (cheque for £5-5s.): H. G. van der Sluis, 16, Koekoeklaan, Den Haag, Holland. Second Prize (cheque for £3-3s.): Frank van Bulck, 31, Avenue Parmentier, Paris, XIe. Third Prize (cheque for £1-1s.): E. A. Rawlings, 5748, Bordeaux Street, Montreal. Prizes of 10/6 each: E. H. Forrest, 9, Laurentian Place, Ottawa, Canada; J. C. Keevy, Church Street, Douglas, Cape Province, S.A.; L. Fisher, 29, Gordon Road, Bertrams, Johannesburg; Marcel Pauwels, Rue de la Couche 9, Antwerp; J. Morris, Chalet Mourezin, Chateau d'Oex, Switzerland; W. L. Creasey, Elsinore, Simonstown, South Africa.

Special Commendation (Certificate of Merit): R. McLeod, Albert Park, Victoria, Australia; Nelson Eustis, Alberton, S. Australia; Charles Granthier, Bareilly, India; P. V. R. Babu, Basavangudi, Bangalore, India; Fritz Hunziker, Zurich.

Overseas "O Outfit" Contest

First Prize (Meccano Products to value £2-2s.): H. W. Turner, 405, St. Aubyn Street W., Hastings, New Zealand. Second Prize (Meccano Products to value £1-1s.): L. H. G. Bollen, Westerstraat 4, Utrecht, Holland. Third Prize (Meccano Products to value 10/6): Edward Holder, 20, Belmont Circular Road, Port-of-Spain, Trinidad, B.W.I.

Special Commendation (Certificate of Merit): N. A. Koot, Rotterdam; S. C. Choudhury, Dacca, India; Malcolm Doig, Strathalbyn, S. Australia; M. Tahir, Pegu, Lower Burma, India; G. D. L. Peris, Slave Island, Ceylon; Lim Tam Chong, Kuala Lumpur, F.M.S.

A Fine Electric Loco

An excellent model of a 4-6-4 Electric Locomotive secures first prize in the Overseas "Locomotive" Contest. This is most realistic in appearance, as will be seen from the illustration, and is built as nearly as possible to scale. It weighs 14 lbs. and is designed to run on gauge 1 rails.

The power is derived from two Meccano Electric Motors mounted in the superstructure, the drive being led down to the main wheels by means of three vertical rods rotated through bevel gearing from rods rotated through bevel gearing from secondary shafts driven by the motors. The drive is transmitted from the vertical shafts to the axles of the six driving wheels by means of $1\frac{1}{2}$ " Contrate Wheels and $\frac{3}{4}$ " Pinions.

The loco is fitted at each end with 4-wheeled bogies attached to

the frame by means of double jointed levers, which leave them free to swivel in all directions. A short Threaded Rod secured in a vertical position to the centre of each bogie carries a 1" fixed Pulley, and the centre hole of the latter forms a cup to receive a Meccano Steel Ball. This presses against a Flat Plate in the engine-frame, and thus

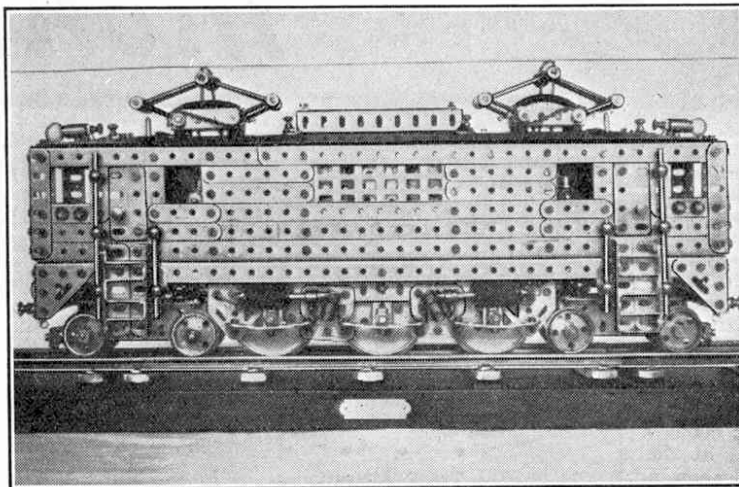

4-6-4 Electric Locomotive, by H. G. van der Sluis. (Awarded First Prize, Overseas Loco Contest)

supports part of the weight of the loco. The load may be distributed evenly over the bogies and driving wheels by adjusting the small Threaded Rods (which are mounted in Threaded Bosses) until the correct pressure against the Flat Plate is obtained.

An interesting feature of the model consists of an electric brake gear. This is operated from four Meccano Coils each wound with ten layers of No. 26 wire, and connected in series. When the circuit is completed they attract $1\frac{1}{2}$ " Rods which slide inside the coils and are connected by means of a portion of a Universal Coupling and an ordinary Coupling to two transverse Rods. A further Coupling is mounted by its centre hole on each of the latter in such a way that, as the magnets are brought into action, their ends press outwards against the circumference of the driving wheels. Small springs (extracted from Spring Buffers) mounted on the sliding $1\frac{1}{2}$ " Rods normally hold the brakes in the "off" position.

Combined Adhesion-Rack Loco

The second prize-winning model, sent in by Frank van Bulck, represents an electric locomotive of the type used in certain mountainous railways for combined rack and adhesion working. The rack system is brought into operation automatically as the loco enters a gradient; it consists of 1" Gear Wheels fitted to the chassis and driven by the Meccano Electric Motor mounted in the loco. The Gear Wheels engage with a series of Rack Strips bolted end to end in the centre of the track.

Some idea of the excellent manner in which the model is constructed is shown by the fact that the loco chassis, alone, will climb a gradient of 54 in 100! The loco complete with superstructure and pulling a heavy coach is capable of overcoming an incline equal to 32 in 100.

I hope to illustrate and describe this interesting model more fully in some future issue of the Magazine.

Other Prize-Winning Entries

The third prize has been awarded for a splendid model of a typical Canadian 2-6-2 locomotive. The design in this case is exceptionally good and points to the fact that the builder must possess a sound knowledge of his subject.

The lower illustration on this page shows an elaborate model of a typical South African loco, submitted by L. W. Creasey. This model was displayed in a local shop, where it aroused much interest. It also appeared in a recent issue of the *Cape Argus*, together with a photograph of its designer.

O Outfit Contest

Some interesting models were received in the Overseas O Outfit Competition, and as soon as the necessary space is available I propose to illustrate and describe in the "M.M." one or two of the principal prize-winning entries. Meanwhile, I may mention for our readers' interest that the first prize was awarded for a Revolving Crane, sent in by H. W. Turner, who also submitted three other models—a Self-emptying Wheel-barrow, Meccano Acrobat and a

Roundabout - Sawsaw combined with an "Ocean Wave." The second and third prizes were won by L. Bollen and E. Holder respectively. The former submitted a miniature automatic Paper-cutting Machine, in which an old safety-razor blade was employed for the knife, while the latter entered a neat model Pumping Engine.

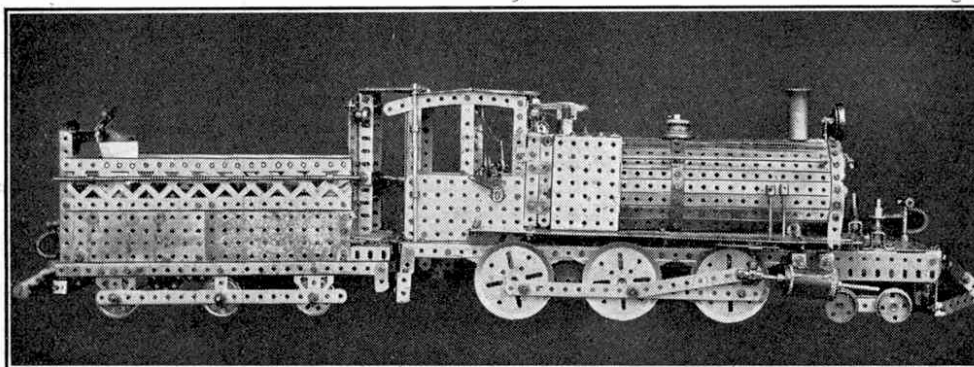

A Typical South African Loco, by L. W. Creasey. (Another prize-winner in the Overseas Loco Contest)

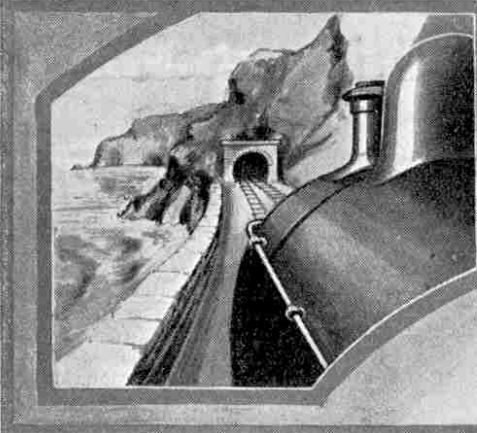

Railway News of the Month

Traffic Guides

With a view to easing the congestion at the three Charing Cross underground stations, the Underground Railways are experimenting with traffic guides to patrol the subways at these stations during traffic hours. The men have been specially selected for their knowledge of London, and they wear distinctive uniforms, including an armet comprising the Underground 'bull's eye' sign, with the word 'Guide' underneath.

Charing Cross is the busiest centre on the whole Underground system, 35,000,000 passengers a year being handled at the three stations, a figure that will show a big increase with the completion of the new extensions.

* * * *

Railway Radio Concert

A successful broadcasting experiment has been carried out by the Great Western Railway (Bristol) Radio Society, when four specially equipped coaches were attached to the 2.30 train from Bristol for Cardiff. Each compartment in the coaches was fitted with a loud-speaker, of which there were twenty in all, and the Cardiff broadcasting station transmitted a special programme throughout the time during which the train was travelling. The programme was picked up as the train left Bristol and instrumental and vocal items were heard with extreme clarity in all the compartments and corridors.

The experiment was so great a success that the G.W.R. made another attempt last month on the Cornish Riviera Express (Paddington to Penzance). An inside frame aerial was used with a seven valve set. Five loud speakers and 20 double headphones were placed in the dining saloon, but the strength was such that the set was capable of supplying on one train either ten loud speakers and 800 headphones, or 30 loud speakers only!

On the outward journey from London music was picked up from Daventry while the train was travelling at over 70 miles an hour, but there was considerable interference owing to the electric generator beneath the coach.

For the return journey arrangements were made to overcome this difficulty and the results were much more successful. At Plymouth, music from Daventry, 225 miles away, was clearly heard, and during the halts at Newton Abbott and Exeter Paris came in very strongly and the crowds on the station platforms were delighted with the surprise entertainment. As the train travelled onward, Daventry was again picked up and after sunset Aberdeen

and Bournemouth were heard with considerable clarity. At Tiverton Junction, "Big Ben" was heard to strike six o'clock, and an hour later, as the train approached Frome, "Big Ben" supplied the seven o'clock dinner gong, the sound being heard all along the train corridor. During the remainder of the journey various other stations were tuned in with remarkable results. The success of this experiment appears to indicate that the installation of wireless for the convenience and entertainment of railway passengers will be a feature of railway travel within the next few years.

* * * *

Track Alterations

In view of the track alterations that are to be placed in hand at Cannon Street Station on the Southern Railway, official notice has been given that the use of the station will be discontinued from Saturday, 5th June until Monday, 28th June.

* * * *

German Loco Works

In contrast with the German aircraft industry, some facts concerning which are given in our Air News this month, several German firms engaged in the manufacture of railway locomotives are proposing to restrict production and, in some cases, to close down altogether on account of the lack of orders. The State railways already possess nearly 5,000 surplus engines. A large percentage of these are out of date, but numbers of modern locos are available. Over 14,000 coaches also are lying idle and while this huge quantity remains unabsorbed the prospect of orders for new vehicles is very remote.

* * * *

L.N.E.R. Report

At the annual general meeting of the London and North Eastern Railway Company held last month, it was stated that during 1925 there was a decrease in traffic receipts of over £1,500,000 and that passenger traffic was responsible for £559,000 of this total. The company carried 5,000,000 fewer passengers, but had run 1,500,000 more passenger train miles than during the previous year, in an attempt to compete with road transport.

* * * *

Projected Tube Railway

The construction by private enterprise of a new passenger tube railway under the Tyne between North and South Shields is under consideration. The Corporations of the two boroughs have decided to oppose the scheme, however, since they regard it as being against their interests.

L.M.S. Orders

The London Midland and Scottish Railway have recently issued particulars of the distribution of contracts for 50 new express passenger locomotives, 5,800 goods wagons and 300 steel under-frames. The locomotives have been ordered from the Vulcan Foundry Limited, Newton-le-Willows. Various English and Scottish firms have secured the orders for the rolling stock, which includes 3,000 merchandise wagons, 500 cattle trucks, 2,000 12-to coal trucks and 300 long rail wagons.

* * * *

New Underground Stations

The Underground Railway have accepted tenders for construction of five stations on the new Morden Tube at South Wimbledon, Colliers Wood, Tooting Broadway, Balham and Trinity Road. The work is scheduled to be completed in six months and there seems to be little doubt that the line will be open to traffic before the end of the summer.

* * * *

New South Australian Bridge

In November last a new railway bridge over the Murray River, South Australia, was opened. The bridge is 1,880 ft. in length and is stated to be the second longest in Australia.

* * * *

Empire-Grown Timber

Following the L.N.E.R. decision to purchase only British-made steel rails, an order for 26,000,000 cubic ft. of Douglas fir has been passed to the Canadian lumber industry by one of the British railway groups. This marks a departure from a tradition dating back nearly 100 years, for hitherto British railway sleepers have almost invariably been of Baltic Pine.

The size of the order may be gauged by the fact that it represents more than the British Columbian export of timber to the United Kingdom for 1923.

* * * *

New L.N.E.R. Tank Locos

In the new tank locos recently put into service on the suburban trains of the Great Eastern section of the L.N.E.R. the driver's position is on the left-hand side in accordance with up-to-date practice. The dimensions of these locos are such that, like those on the Great Northern section, they may be used for the Metropolitan Railway.

Past and Present: Two Famous Locos

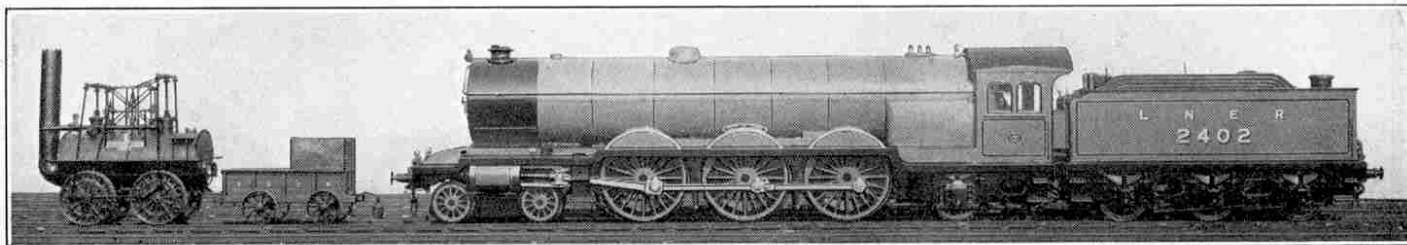

"Locomotion No. 1," the first loco to run on the Stockton and Darlington Railway (1825) and L.N.E.R. Pacific Loco—2402, "City of York" (1925), one of the latest express passenger engines

Garratt Locos for India

Messrs. Beyer, Peacock & Co., have recently given delivery of the two Garratt 2-8-8-2 locos for the Bengal-Nagpur Railway, 5 ft. 6 in. gauge. These locos are to work on the heavy section between Chakardarpur and Jharsuguda, the average gradient of which is 1 in 100, and will haul loads of from 1,500 to 1,600 tons.

* * * *

Railway Birthday

The Mersey Railway, running under the River Mersey between Liverpool and Birkenhead, recently celebrated its 40th birthday, and it is interesting to observe some of the details of its progress. The line was officially opened for traffic by the late King Edward VII., on 20th January, 1886, and regular running of the trains commenced in the following month. Originally steam trains were employed and the service was limited to a total of 30 journeys per day through the tunnel. To-day the electric trains make 450 to 500 journeys per day. It is estimated that nearly 500,000,000 passengers have used the route, but owing to through bookings on the adjoining G.W. and L.M.S. lines it is not possible to give the exact figures.

* * * *

Engineering Feat on S.R.

Towards the end of January an interesting engineering feat was successfully accomplished at Cannon Street Station, in connection with the electrification scheme. A huge iron girder had to be placed in position in the bridge over the Thames to permit the re-arrangement of the lines crossing the bridge. The work was commenced on the evening of 15th January and carried on in shifts by over 100 men, with the aid of acetylene flares, in the midst of falling snow.

The girder, 140 ft. long and weighing 72 tons, was moved into place, ready for pivoting and dropping to its final resting point, by two 36-ton cranes. On the night of the 16th the task was to lower the girder a distance of 11 ft. into its final position on the distributing girders that bear its weight. First one end, and then the other, was gradually lowered, extreme care being taken to prevent too rapid a descent. Packing had been placed underneath the girder and this was removed bit by bit until the distributing girders were reached.

The work was completed at midnight and the tracks were quickly restored to permit the ordinary steam traffic time-table to be worked at its full programme.

New Southern Locos

The ten new "River" class locos at present being built at the Southern Railway Company's Brighton Works are expected to be ready for service in June. They are numbered from 800 to 809 and bear the names of the following rivers:—

"Cray," "Darent," "Cuckmere," "Itchen," "Tamar," "Camel," "Torridge," "Axe," "Char" and "Dart."

* * * *

A Long Engine Run

Many railways in the United States are adopting the policy of making one loco do the work that a few years ago was considered to require two or three locos.

Loco No. 6157, of the Chicago, Milwaukee, and St. Paul Railway, made a splendid run recently in hauling a train consisting of 13 steel passenger cars over the entire distance of 805 miles from Chicago to Mobridge, South Dakota, without being detached from the train.

No. 6157 is an ordinary standard type "Pacific" loco with cylinders 25 in. by 28 in. and 79 in. driving wheels. The grate area is 59 sq. ft., the steam pressure 200 lb., and the tractive effort 37,658 lb. In regular service this loco and another of the same class haul 12 to 15 steel passenger cars between Chicago and Minneapolis, a distance of 421 miles.

* * * *

South African Developments

As most of our readers know, the railways in South Africa are owned by the Union Government, which appears to be tackling transportation problems in a progressive spirit. In 1910 the country was served by 7,500 miles of line, but to-day that figure has grown to 12,500 miles. Recently the Government has been authorised to proceed with the construction of another 1,000 miles of line to open up some of the practically virgin agricultural and industrial tracts in different parts of the Union.

The Natal main line, an exceedingly busy line carrying a big export traffic in coal and agricultural products, has been electrified over a stretch of 300 miles. In the Cape Peninsula steady progress is being made with the electrification of the suburban services.

The engine power and rolling stock is being improved in various parts of the country in preparation for the improvement of trade that must inevitably follow the internal developments now being pushed forward.

Another Railway Record

The year 1925 will be noteworthy in British railway history, for not a single passenger was killed in an accident. This record has only been equalled in two years, 1901 and 1908, since 1850.

* * * *

Water Columns

Our readers may have noticed that occasionally the L.M.S. depart from their usual custom of painting water columns and tanks black, and instead paint some yellow and a few red. The explanation is that the supply from the red tanks must not be used except in cases of extreme necessity. This restriction may be due to various causes, such as the supply being unsuitable or the column being placed in such a position that locos standing by it cause delay. The columns passed prior to reaching a red one are painted yellow as a warning to drivers to fill up and not postpone the operation until they reach a red column.

* * * *

Longer American Rails

Another step towards improvement in railway operations in the United States is indicated by the announcement of the American Railway Association that new specifications have been approved in accordance with which the length of rails will be increased to 40 ft. This is an increase of 6 ft. as compared with the rails now in use, but the weight per yard remains unaltered.

This increase in length will effect a marked saving, not only in the cost of installation of new rails, but also in track maintenance charges. For instance, there will be a reduction of 16 per cent. in the number of rail joints and a similar saving on bolts, nuts, joint-bars and screw-washers, used in connecting the rails. The reduction in the number of joints should have the effect of reducing the liability to accident, for it has been clearly shown that a large number of the rail breaks, due to wear and depreciation in rails, appear at the joints. In addition, the increase of length will make for smoother running, since the number of shocks due to passing over joints will be reduced.

It is interesting to note that the Americans have not yet reached the standard of rail construction attained in Great Britain, where 45 ft. rails are common on the main lines. Indeed, several years ago the old London and North Western Railway Company adopted 60 ft. as their standard, and it is only the higher price demanded by manufacturers that has deterred other companies from following this lead.

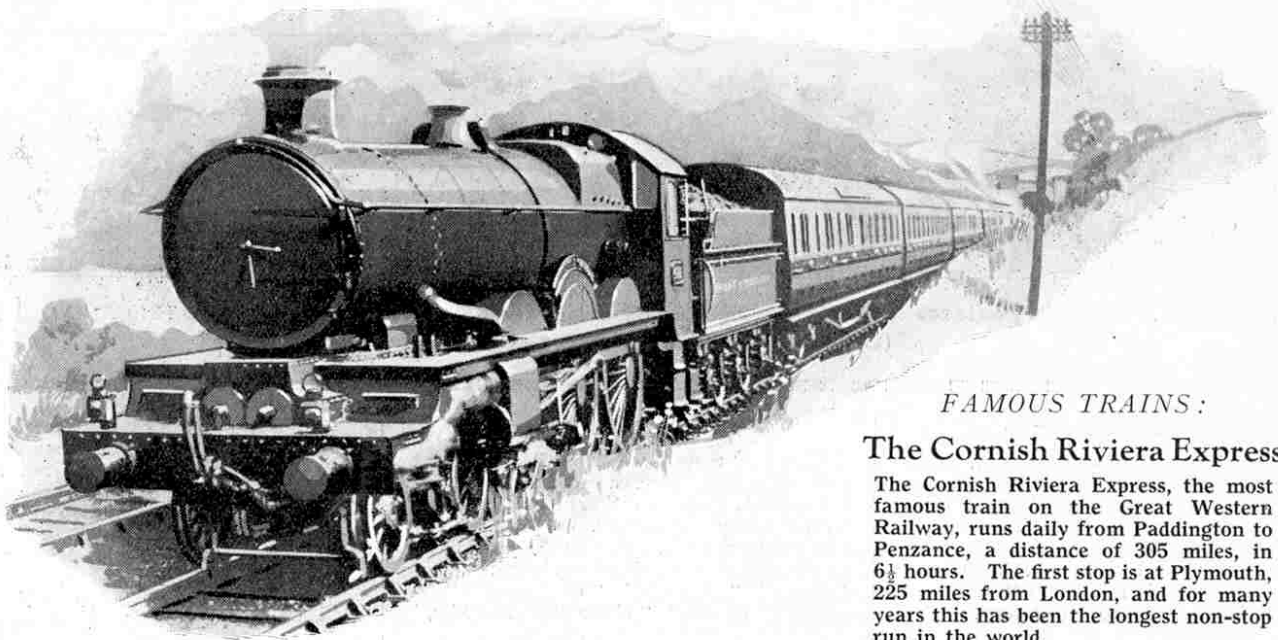

FAMOUS TRAINS:

The Cornish Riviera Express

The Cornish Riviera Express, the most famous train on the Great Western Railway, runs daily from Paddington to Penzance, a distance of 305 miles, in 6½ hours. The first stop is at Plymouth, 225 miles from London, and for many years this has been the longest non-stop run in the world.

HORNBY CLOCK WORK TRAINS

BRITISH AND GUARANTEED

Real trains are made of steel and then painted in their correct colours—so are Hornby Trains.

Real trains pull heavy loads over long distances—so do Hornby Trains.

Real trains are not scrapped when one part goes wrong or gets broken. They are sent to the repair shops and a new part is fitted. The same thing happens if you break any part of a Hornby Train.

Real railways don't consist of only a locomotive and a couple of carriages. There are stations, signals, goods wagons, points, level-crossings, loading gauges, breakdown vans, snow ploughs. All these and many other accessories are included in the Hornby series.

Real trains don't run round and round a circular track all day, neither do Hornby Trains. You can build up a REAL railway system in miniature—complete to the smallest detail—if you like. That's why Hornby Trains are such good fun—they're so real that you don't just play at trains—YOU OWN AND RUN A REAL RAILWAY.

PRICES

No. 0 Passenger Set	... 24/-
No. 0 Goods Set	... 17/6
No. 1 Passenger Set	... 27/6
No. 1 Goods Set	... 21/-
No. 2 Pullman Set	... 60/-
No. 2 Goods Set	... 37/6
No. 1 Tank Goods Set	... 25/-
No. 2 Tank Goods Set	... 45/-
No. 2 Tank Passenger Set	45/-

Ask your dealer to show you the Hornby Trains

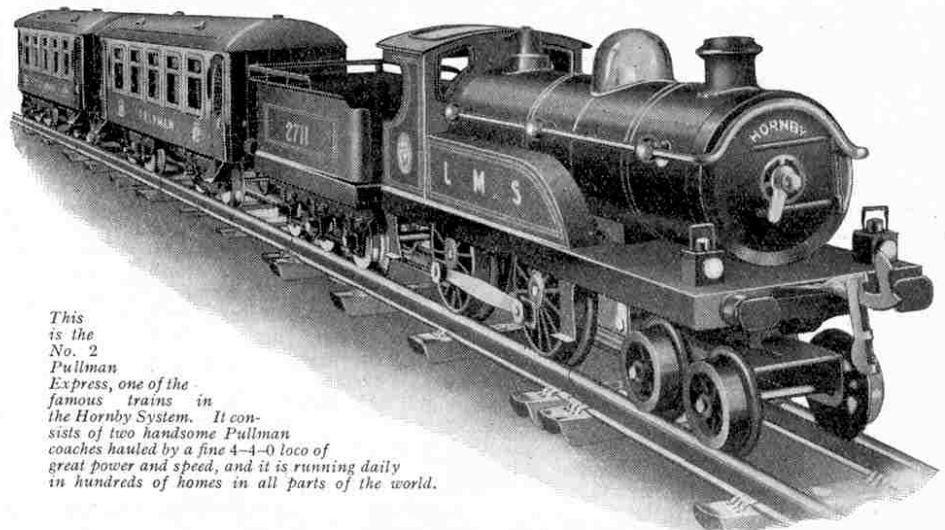

This is the No. 2 Pullman Express, one of the famous trains in the Hornby System. It consists of two handsome Pullman coaches hauled by a fine 4-4-0 loco of great power and speed, and it is running daily in hundreds of homes in all parts of the world.

MANUFACTURED BY

MECCANO LIMITED, Binns Rd., LIVERPOOL

A Three-cylinder Tank Loco

First of Ten New 2-6-4 Locos for the Southern Railway

Early in 1923, one of a batch of 2-6-0 tender engines for the Southern Railway was built with three cylinders instead of two. Similarly, one of ten 2-6-4 type superheater tank engines to the design of Mr. R. E. L. Maunsell, the Chief Mechanical Engineer, has now been built at Ashford Works, with three cylinders, 16 in. diameter

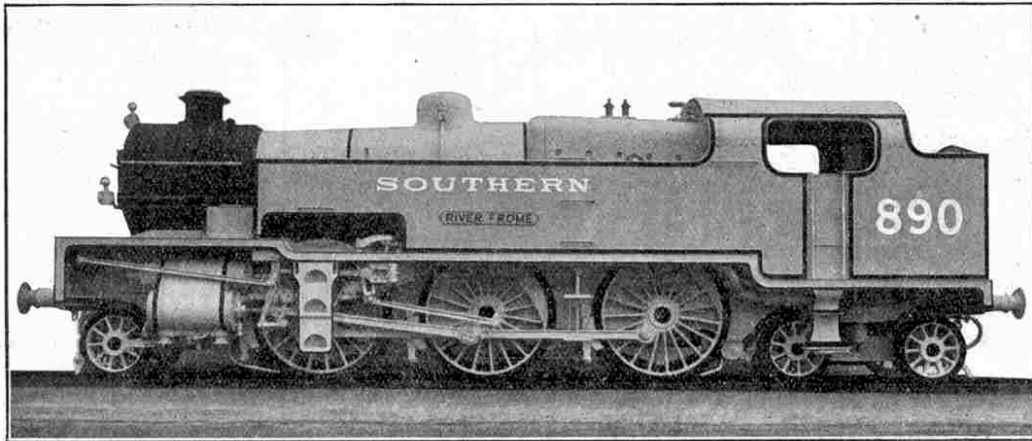

Courtesy]

The New 2-6-4 Tank Loco "River Frome"

[Southern Railway

by 28 in. stroke. The cylinders and motion are interchangeable with the 2-6-0 three - cylinder engine No. 822, whilst the boiler, wheels, and other details are identical with those of the two-cylinder tank engines.

The arrangement of valve gear, as before, consists of two Walschaerts gears for the valves of the outside cylinders. Rocking levers, connected to the outside gears through extension rods, operate the valve of the inside cylinder.

The single-throw crank axle is of the built-up type

balance weights, making for greater inter-changeability. The inside connecting rod is of the strap bolt pattern,

with extended webs to form counter-weights. These balance the crank pin and part of the connecting rod, so that the same wheel centre castings as used for the two-cylinder engines can be utilised by a little adjustment to the while the outside rods are of the plain bushed type.

The engine is numbered A890 and has been named "River Frome." It has, as far as possible, been made identical with the two-cylinder engines of the "River" class at present working on the Southern Railway, with the object of comparing three and two-cylinder simple engines both as regards performance and cost of

Details of Southern Railway Three-Cylinder and Two-Cylinder Tank Locos.

	Three Cylinder.	Two Cylinder.
BOILER.		
Working Pressure	200lb. per sq. in.	200lb. per sq. in.
Barrel diameter out., front.....	4 7/8 in. dia. x 9/16 in. thick	4 7/8 in. dia. x 9/16 in. thick
Barrel diameter out., at firebox.....	5 ft. 3 in. dia. x 5/8 in. thick	5 ft. 3 in. dia. x 5/8 in. thick
Barrel length.....	12 ft. 6 in.	12 ft. 6 in.
Firebox shell—width.....	4 ft. 0 1/2 in.	4 ft. 0 1/2 in.
Firebox shell—length.....	8 ft. 0 in.	8 ft. 0 in.
Tubes 1 1/2 in. out. diameter.....	175	175
Tubes 5/8 in. out. diameter.....	21	21
Heating Surface—Firebox.....	135 sq. ft.	135 sq. ft.
Tubes.....	1,390.6 sq. ft.	1,390.6 sq. ft.
TOTAL.....	1,525.6 sq. ft.	1,525.6 sq. ft.
SUPERHEATER (21 elements).....	285 sq. ft. (inside)	285 sq. ft. (inside)
GRATE AREA.....	25 sq. ft.	25 sq. ft.
CYLINDERS.		
Number.....	3	2
Size.....	16 in. dia. x 28 in. stroke	19 in. dia. x 28 in. stroke
Piston Valves.....	8 in. dia.	10 in. dia.
Travel (maximum).....	5 1/2 in.	6 7/16 in.
WHEELS.		
Front Bogie (Bissel).....	3 ft. 1 in. dia.	3 ft. 1 in. dia.
Coupled.....	6 ft. 0 in. dia.	6 ft. 0 in. dia.
Trailing Bogie.....	3 ft. 1 in. dia.	3 ft. 1 in. dia.
TRACTIVE EFFORT (at 85 per cent. boiler pressure).....	11.34 tons	10.65 tons
TOTAL WEIGHT OF ENGINE in working order.....	88 tons 15 cwt.	82 tons 12 cwt.
TOTAL WEIGHT ON COUPLED WHEELS.....	56 tons 15 cwt.	52 tons 15 cwt.
TANK CAPACITY.		
Water.....	2,000 gallons	2,000 gallons
Coal.....	2 1/2 tons	2 1/2 tons

maintenance in passenger service.

The accompanying table gives an interesting comparison of the dimensions and weights.

Fast G.W. Run

An exceptionally fast run was made recently by a Great Western "Castle" class loco with passengers disembarked from a liner at Plymouth. The journey from North Road Station, Plymouth, and Paddington, a distance of 226 miles, was covered in 3 hours 54 minutes, start to stop, at an average speed throughout of 58 m.p.h. Between Westbury and London the average speed was as high as 64.8 m.p.h. for 95 1/2 miles continuous travelling.

L.N.E.R. Statistics

Some idea of the extent to which the L.N.E.R. serves the population of Great Britain is afforded by some recently issued statistics. There are in Great Britain 92 towns (exclusive of London) of over 50,000 inhabitants, their aggregate population reaching 10,500,000. Of this population 80 per cent. is served by the L.N.E.R. The company has a route mileage of 7,000, owns 2,500 stations and goods depots, 38 docks with 38 miles of quays, and employs some 224,000 individuals.

New Rhodesian Railway

The construction of a railway from the Rhodesian main line south of Gwelo to Shabain, to serve the important asbestos industry in the latter district, is under consideration. At present practically all the transport from the Shabain district to the railway, sixty miles distant, is by ox wagon. The Government also intend to construct a bridge for rail and road traffic over the Limpopo at Messina. The completion of this project will link up main line traffic with Natal and the Rand,

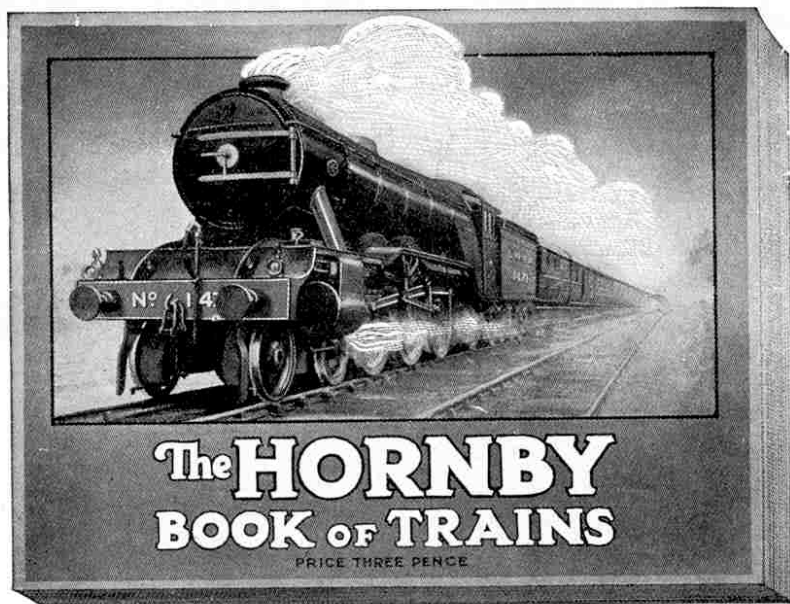

New Edition Now Ready

So great has been the demand for this splendid publication "*The Hornby Book of Trains*" that several editions have had to be printed and already over 130,000 copies have been sold.

In response to requests from many new readers of the "*M.M.*," who did not see the original announcements and who therefore were not able to order a copy of "*The Hornby Book of Trains*," we have printed a final edition, which is now ready. Any reader who has not already had a copy of this fine book should order without delay, as no further copies of this edition will be printed.

The "*Hornby Book of Trains*" is a splendid production in every way, and no effort has been spared to make the publication worthy of the name it bears. It consists of 44 pages (11" x 8½") of special art paper and on the cover, illustrated above, is a magnificent reproduction in colour of the L.N.E.R. "*Flying Scotsman*" at speed, which is well worth framing.

What the Book Contains

The first half of the book is devoted to the story of the locomotive from its earliest days, dating to before the time of the opening of the first passenger line.

The following are the chief sections:—

- The Development of Iron Rails
- The Stockton and Darlington Railway
- The First Railway Companies
- The Classification of Locomotives
- Early Steam Locomotives
- The Liverpool and Manchester Railway
- Development of the Passenger Carriage
- Famous Trains

The second half of the book includes a beautifully illustrated description of all the Hornby Trains and the latest Hornby Series Rolling Stock and Accessories. These illustrations are printed in four colours and the reproduction of the Hornby Trains is most realistic.

Address your orders to "*Hornby Book*," Meccano Limited, Binns Road, Liverpool, and please write your name and address clearly. The book will be posted to you by return of post.

The price of the book is 3d. (post free) which may be sent in stamps. There is no reduction if more than one copy is ordered.

Orders from Overseas

There is a special edition of "*The Hornby Book of Trains*" for Overseas readers. Readers overseas should address their orders to our Overseas agencies as below.

AUSTRALIA: Messrs. E. G. Page & Co., 52, Clarence Street, Sydney, N.S.W.
 NEW ZEALAND: Messrs. Browning, Ifwersen Ltd., P.O. Box 129, Auckland.
 SOUTH AFRICA: Mr. A. E. Harris (P.O. Box 1199), Textile House, Von Brandis Street, Johannesburg.

Readers living in countries other than those mentioned should order from Meccano Ltd., Binns Road, Liverpool, England, and send a postal order for 6d. with their order.

The price for all orders from outside the United Kingdom is 6d. per copy, post free.

"MECCANO MAGAZINE" SPRING BACK BINDER



There is no better way of keeping your Magazines clean and tidy than by binding them in the special binder we supply for this purpose.

This binder has a strong stiff back, and holds a large number of copies. Covered in black imitation leather, tastefully tooled, lettered gold, its price is 3/- post free, from Meccano Ltd., Binns Road, Liverpool.



In this column the Editor replies to letters from his readers, from whom he is always pleased to hear. He receives hundreds of letters each day, but only those that deal with matters of general interest can be dealt with here. Correspondents will help the Editor if they will write neatly in ink and on one side of the paper only.

F. F. Harrison (Sunderland).—There are numbers of Meccano boys in Sunderland, Frank, and you should have no difficulty in starting a Meccano Club. We have already sent you some helpful literature. Let us know how you progress.

A. E. Jackson (York).—The rule of the road in regard to passing vehicles on the right, or off-side, applies to all vehicles except tramcars, which should be passed on the inside. In passing a tram, however, care must be taken that no passengers are about to alight from it or about to cross the road to board it.

R. L. Wilkinson (Brisbane, Aus.).—We were interested in hearing all about the "*Century Fire*," the single engine boat that established the world's record of 72 m.p.h., and of her remarkable accident this year, when she hit a floating bottle which broke a blade of her propeller, compelling her to retire from the race. Thanks for photo of "*Miss America*."

M. E. Myers (New Lambton).—We are pleased to know all about the hobbies you like best, and we congratulate you on winning two prizes in a month. Thanks for snapshot of motor car racing-track accident. It was indeed a dreadful affair.

R. Garcia (San Juan, Trinidad).—San Juan must be a very beautiful place judging by your description. Lots of English people go out to your city for a holiday now to enjoy your climate and scenery. Thank you for your congratulations—we too wish we could shake hands with you.

G. S. Dobson (Barrow-in-Furness).—Your nearest broadcasting station is Manchester, from whence it would not be possible to receive telephony on a Crystal Set.

G. Seaborn (Moose Jaw, Sask.).—Thanks for your graphic description of the train wreck close to your home. We could follow it quite clearly from your diagram. We are always glad to hear from you.

C. Hastewell (Rhos-on-Sea).—Both station and coaches look much better of course when fitted with electric lights, and we congratulate you on so successfully electrifying your system. It sounds a good idea to have Christmas oftener, but before finally deciding, ask your father and mother and let us know their views!

D. Hartnell (Bundaberg, Aus.).—Thanks for your interesting letter and photo of yourself. You appear to be leading a healthy and happy life. An expert swimmer, able to drive your father's car, and Meccano and Hornby Trains as indoor hobbies, is not bad for a boy of thirteen.

C. M. Cockin (York).—We are really very sorry Charles, and we will try our hardest not to use split infinitives in the "*M.M.*" in future! We will also have more competitions for lynx-eyed readers. There is always an index of the main features on the last page of each number of the "*M.M.*"

D. Thorp (Port Stanley, Ont.).—Thank you for sending us a long newspaper account of the engineering successes of Mr. R. L. Dunsmore. It is gratifying to know that he commenced his career by building Meccano models.

K. Yoshida (Tokyo).—Your letters always give us pleasure. We hope "M. le Consul-General du Japon" has returned safely from Mukden and joined his boys again. We note your wish for another big model competition and we are considering the matter.

D. F. Waddington (Bristol).—We are very glad to know that you have constructed a Receiving Set from Meccano parts. Possibly with an outside aerial, you may be able to receive broadcast from Cardiff, but at that distance reception with an indoor aerial will be doubtful.

C. Webb (Hove).—"It is a great joy to me to see the boys working out their own ideas in connection with the Meccano Club, and I congratulate you on putting before them such an admirable and instructive pastime as Meccano." We are always very glad to see parents take such a keen interest in their boy's activities and we trust that with your help Roy will be able to place his club on a sound basis.

G. Howard (Dunedin, N.Z.).—We were very glad to hear from you again and to know about the Dunedin Exhibition, but you have only described the pleasure side of it. Tell us all about the exhibits and if possible send us some good photographs. We will try to find you a suitable French correspondent.