

Railway Comfort 100 Years Ago

The Development of the Passenger Carriage

IT is a far cry from the early railway carriages—more closely resembling bathing machines than passenger vehicles—to the luxurious Pullmans of to-day, but the story of the evolution is one of gradual progression and improvement, exactly as it was in the case of the locomotive itself.

The first railways were not built with the idea of carrying passengers—they were introduced for the transport of coal, passenger traffic being only a secondary consideration. Ultimately, of course, passenger traffic became of greater importance than the transport of coal, and as a result more attention had necessarily to be paid to the question of comfortable accommodation.

The First Passenger Coach

On that historic day, a hundred years ago, when the Stockton and Darlington Railway was opened, a passenger coach, to accommodate the directors and their friends, was included in the train. There were also twenty-one chaldron wagons for other passengers in addition to twelve loaded wagons. "The signal being given," said a witness of the scene, "the engine started off with this immense train of carriages."

Those of us who were fortunate enough to witness the Centenary procession at Darlington in July last, saw an exact copy of this early coach in the replica train that took part in the historic celebrations.

This first railway coach was designed by George Stephenson and was very properly named the "Experiment." It was little more than a box on four wheels, but it served the purpose of showing that passengers could be carried successfully by rail. By the time the Liverpool and Manchester line was opened the passenger vehicles had improved a good deal. They were then practically stage coaches on railway wheels, and from early illustrations it may be seen how close was the resemblance. At this time, many people travelled on the railway in their own private carriages that were run on to flat trucks, and so made certain of a comfortable and well-sprung seat!

In these early stage coach vehicles there were usually three compartments, one first-class in the centre and



Old Chaldron Wagon used on S. & D. Railway

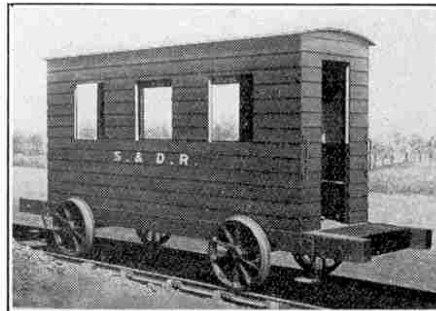

"The Experiment"—First Passenger Coach (1825)

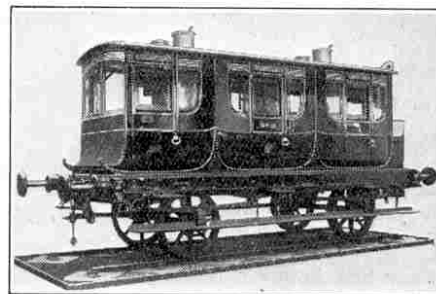

Coach used on London-Birmingham Railway (1842)

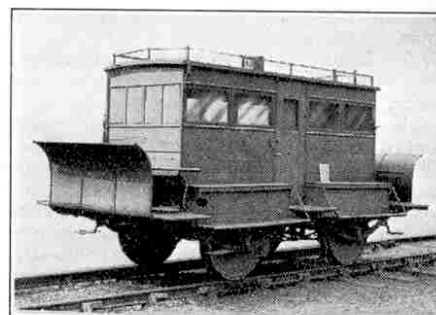

A horse-drawn carriage used on the N.B.R.

a second-class at each end. Luggage was placed on the roof and the guard also was given a seat at the end of one of the carriage-tops.

Carriages Without Windows

Third-class passengers received very little consideration. At first they travelled in open trucks, and even when these trucks gave place to so-called carriages no attempt was made to make the vehicles comfortable. Windows were only fitted in the doors, and the seats were of plain wood without any upholstery.

We can readily understand that in these circumstances cartoonists and humorous writers of those days found much material in the unfortunate third-class passenger and his rough and ready treatment!

Passenger traffic grew with surprising rapidity on all the important lines and gradually longer carriages with more comfortable fittings were introduced. After a while it was found that the length could not be increased further if the coaches were to negotiate curves with safety, and this resulted in the introduction from America of bogie trucks by means of which coaches of great length could ride easily round curves.

First Dining Cars

Dining cars were adopted by the Great Northern Railway in 1879 but the trains were not then fitted with corridors and vestibules. Incidentally the meals were cooked before the train began its journey and were kept as hot as was possible until the meal hour!

The credit for the first corridor express with dining cars attached must be given to the old L.N.W.R. which ran a well-fitted express daily from Euston to Scotland.

Pullman cars were introduced from America by the Midland Railway in 1875, and that company also took the drastic step of abolishing second-class carriages and making every train available for third-class passengers.

The first Pullmans were very successful. It was found that these smooth-riding cars were the safest portion of the train and this fact led

(Continued on page 257)

Initiating Mr. Smithers

This is a story, reprinted by permission from "The Electrical Review," of a young electrical engineer who "came and went," deciding that the life of an electrical engineer is not such an easy one as some people seem to believe.—*Editor.*

I WAS just considering the question of packing-up for the day when the bell summoned me to the Manager's office. As I wended my way there I cast about in my mind for any technical omissions I might have made recently, for, as a rule, a summons to the Chief meant but one thing—that there was "something up." I had hastily gone through a mental review of two recent jobs by the time I had reached the sanctum, and as I opened the door I began to marshal the facts relating to another job that was not quite so favourable.

My trend of thought was completely upset, however, by the unusual aspect of my Chief, whose customary highly-critical demeanour was conspicuous by its absence. His gaze, usually of an e.h.p. quality and directed point-blank at the arriving victim, was unexpectedly mild, and it was lingering upon someone else. The latter was a young fellow, who (remarkably enough) appeared perfectly at ease. Indeed, a chance on-looker would have identified him as the most impressive character in the room.

"Oh—er, Davis," said the Chief, turning to me. "This is Mr. Smithers, who is joining us for an insight into—our er—work. I'd like you to take him along with you to-morrow and initiate him. He might as well be getting on with these four jobs."

On the following morning I had some difficulty in locating the latest arrival, but eventually found him, in a state of abstraction, behind "The Wireless World." He appeared somewhat taken aback and, to my relief, not quite as impressive as on our first meeting.

After an exchange of "Good mornings!" and as he did not seem inclined to forsake his wireless paper, I remarked, "We'd better be getting along"—at which he made a move. "By the way," I went on, "I wouldn't advise you to wear such good togs on our work. The jobs to-day, for instance, are a bit rough-and-ready, so to speak."

"Oh, that's all right," Smithers hastened to assure me. "I know what electrical work is like."

During our run in the car to the first place I gathered that Smithers, after leaving college with a technical degree, had found some difficulty in adapting himself to the practical world. Yes, electrical work appealed to him. He seemed, though, to be under the illusion that the life of an electrical engineer was a perpetual round of glorified lab. work.

Our first halting-place was in the nature of a rude awakening, however, for it was a flock factory. Here a number of carts were unloading sackfuls of rags, which were first placed in ovens. Inside the factory proper were a number of machines looking very much like a.c. generators,

at my power-factor and other details I, too, hastened to leave. Smithers was conversing with the foreman. "Been long here?" said the latter, with a hearty and fluffy laugh. "Lor' bless yer, yes—a matter o' fourteen years!"

For some miles Smithers was silent but still restless. At last he enquired as to our destination. I told him we were now bound for a soap and candle works, and tried to comfort him by assuring him that there was no reason to expect an atmosphere like that at the flock factory. This was not altogether accurate, perhaps, because the atmosphere we presently entered more than made up in aroma for what it lacked in solid matter.

Our technical work here dealt with the metering. The works were on a day-and-night tariff, and as the day meter had gone on strike and the night meter was working a 24-hour shift, the works was receiving all energy at the cheaper rate.

When the fault was located and we reached the fresh air, Smithers expressed the view that it was a wonder *anything* worked in such a place as that! "Besides," he added, with some indignation, "what do people want with candles nowadays? Soap I suppose we need, but candles . . .!"

When he heard that the next job was down a pit he cheered up surprisingly. I hinted that we should have some work to do—as a matter of fact we had more than I bargained for!

At the pithead we met the electrician and had a long and cold wait while a "set" of tubs were hauled to the bank. I donned overalls and cap, while Smithers elected to retain his overcoat in lieu of dungarees.

The banksman signalled to us to get into the cage. . . . The cage dropped and Smithers gasped! The shaft was a wet one, and water splashed on to the cage in streams. Smithers's overcoat was not so out of place after all!

At the bottom we paused awhile to attune ourselves to the new surroundings, the onsetter meanwhile regarding Smithers's trilby and overcoat with frank amazement! Then, burdened with current transformers, instruments and lamps, we set off inbye—the electrician leading the way. For a while we clambered and splashed over tramlines in a main road. The roof lowered, and abruptly we turned to the right, down a steep incline. Bent nearly double, and half-slithering, half-walking, I managed to keep in sight of the electrician. Behind me I could hear Smithers stumbling along. I was per-

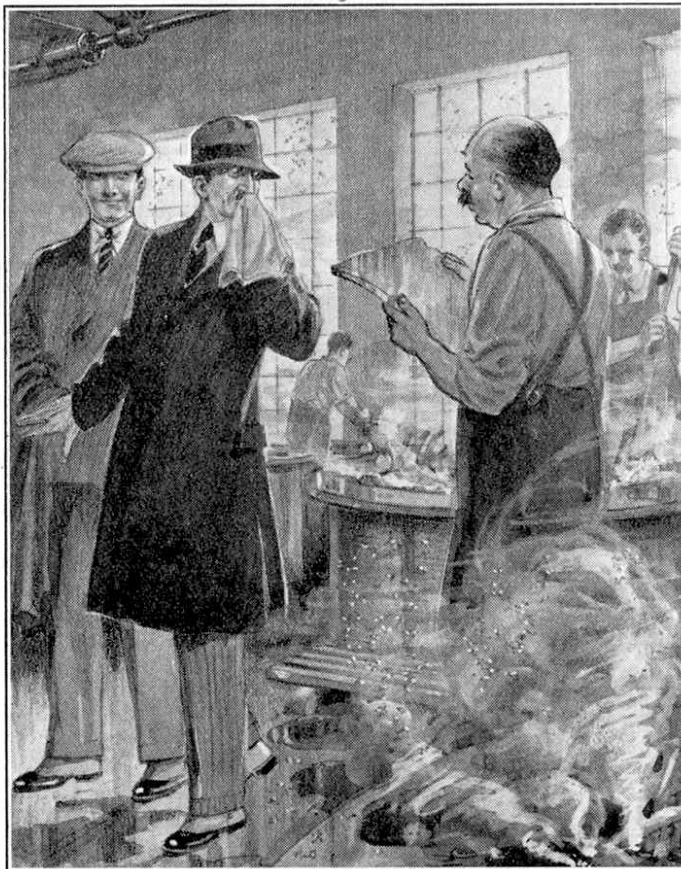

... If ever you want a good piece of glue, just you come along here!"

the rotors, however, bearing nasty-looking spikes. Into these machines the rags were fed, to emerge from the tearing process as flock. They were driven by electric motors, and, as I explained to Smithers, our job was to investigate the electrical conditions following on the installation of some static condensers.

Smithers seemed to be in no mood for technical matters, however, and as time went on his interest decreased to zero. This was understandable, and due to a detail which I have neglected to mention. The atmosphere of the factory was stiflingly hot, and full of tiny, irritating fragments of flock. These had filled all the crevices in the walls, and every article in the place bore deep layers of flock—the Supply Co.'s meters and cables being especially favoured. Smithers' discomfort impelled him to retire from the scene, coughing and itching. Having arrived

spiring freely and did not envy him in his overcoat!

The electrician halted. We had reached our objective—a wet and dimly-lighted pumphouse. Here was a pump driven by a 60 h.p. electric motor, the working conditions of which were to be investigated. Smithers was exhausted and sad, and, I am afraid, was not of much help. I do not think he was able to reconcile his ideas of electrical engineering to the crude actuality.

At length our investigations were duly completed, in spite of water and bad light and Smithers's wilting state. After a hard climb back to the shaft-bottom, and another wet journey to bank, we were once more on the surface, and on our way to the last job.

Smithers seemed to be thinking hard, and at last volunteered the statement that he would never again criticise miners! After another spell of thought he went on to admit (frankly, if ingenuously) that electrical engineering was not what he had expected. When I gently made the inevitable rejoinder he hesitated, and his answer, beginning with a floundering attack upon his technical education, ended by a confession of his keen interest in wireless. (No wonder he had, earlier in the day, been so contemptuous of our local frequency of a mere 50 cycles!) He was commencing a description of his latest "super-het" when the increasing flavour of the air informed me that our last destination (a glue factory) was near at hand.

Smithers was visibly reluctant to enter the place, but during a breather in the office he must have pulled himself together, for when I appeared with the engineer he followed us without apparent hesitation.

The technical trouble here lay in the fact that the normal maximum demand had suddenly risen. The engineer's ideas ament his hourly maximum demand were hazy—as often is the case. Having examined the demand indicator and found it in order, by some judicious inquiries we elicited the real cause—the gelatine section of their factory, long dis-used, had been opened again.

Our wanderings took us through an atmosphere hot and stinking. At one place we passed a mysterious tank around which a dense crowd of big flies were busy. Hides, skins, and bones were being melted in open boilers, and the glue-stock boiled in water. In wooden congealing boxes the gelatinous fluid formed into stiff jelly, after which it was cut up and dried. All these interesting operations were marred by the abominable stench. Smithers looked sick and I hastened to depart. The foreman, with an air of pride, showed us a sample sheet of glue, and explained how the beautiful polish was obtained by re-dipping in water and again drying. "A fine bit of stuff," he said, passing his hand lovingly across it. "If ever you want a good piece of glue, sir, just you come along here!" At this Smithers fairly shot out of the place.

On our homeward journey he contented himself with a large number of abnormally deep breaths, and his "good night" was uttered in rather dejected tones. I forebore to press him for an opinion of his day's experience but saw him next morning engaged in a confab. with the Chief, after which he disappeared and "our place" knew him no more. Later in the day the Chief announced briefly

120 Miles an Hour!

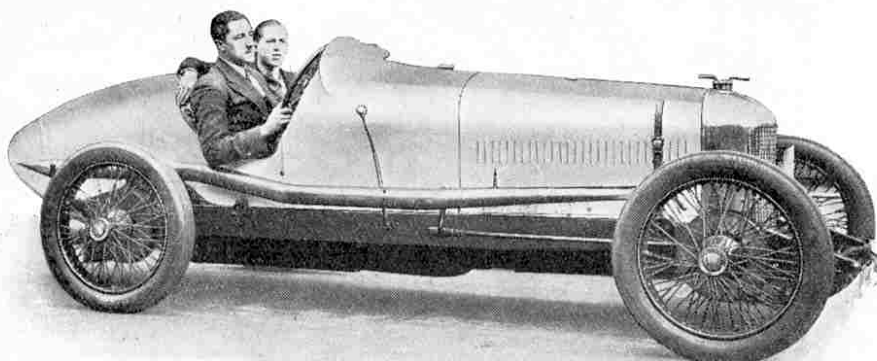

Those of our readers who are keen on motor racing will be interested in the above illustration of the well-known racing car, the "Miller 'eight.'"

This car, which is capable of well over 120 m.p.h., was built in America at a cost of £3,000. After being raced there it was purchased by that famous motorist Count Louis Zborowski, but the Count, unfortunately, never had an opportunity of really testing the car, being killed while racing last year.

The car now belongs to Mr. D. Higgin, of Liverpool, and in his hands has gained

many local successes. At a recent meeting of the Southport Motor Club, for instance, held on the Southport sands, the "Miller" swept the board, obtaining five firsts and one second out of six races, as well as leading all the way in the 10-mile race until the last lap, when it caught fire. Fortunately the fire was extinguished before any serious damage was done, but the car was unable to finish.

The "Miller" has a straight-eight engine of 1886 c.c. and is fitted with four carburettors and Remy ignition system.

that "Young Smithers is not continuing with us."

* * * *

Whom should I meet in town a week later but Smithers himself! He appeared supremely satisfied with existence and his greeting, whilst a trifle lordly, was tinged with a certain respect—perhaps he admired my courage in professionally penetrating into noxious regions. He was now, it appeared, with a radio engineer and "doing well." I congratulated him on dropping into a more congenial sphere and, as we parted, told him that there was one thing he need never want. He looked puzzled. Then I reminded him of the kind offer of the glue factory foreman: "If ever you want a good piece of glue, just you come along here." Smithers's face paled, a shudder passed over him, and he hurried away!

Railway Comfort 100 Years Ago—

(Continued from page 255)

directly to the adoption of much heavier coaches on most of our main lines.

Many of the long-distance expresses to-day have Pullman cars attached, and for a small additional charge both first-class and third-class passengers may travel in these luxuriously-fitted vehicles. Pullman carriages are the property of the Pullman Car Company, and run on the various railways by arrangement.

Sleeping cars were first used in America and consisted of large vehicles, the seating arrangements in which could be easily adapted for night use. In this country they were first used on the West Coast route in 1873.

In the old days very little consideration was given to the lighting of railway coaches. As the number of passengers increased,

however, it became necessary to have some regular system of lighting, and oil lamps were introduced. From the accounts of passengers in those days these lamps were evil-smelling affairs giving a miserably poor light. The next step was the introduction of oil gas with flat flame burners. This improved matters considerably, but a really efficient light was not obtained until the introduction of the incandescent burner which is still largely used.

Incandescent lighting has certain disadvantages, however, the chief of which is danger from fire, and on account of this danger the present-day tendency is to abolish gas entirely and to light trains throughout by electricity. On electrified railways the current for lighting purposes exists already, but on steam-driven trains a small dynamo is fitted beneath each coach and driven from one of the bogie axles. In order to maintain the light when the train is at a standstill, or running too slowly for the dynamo to generate sufficient current, an accumulator battery is provided and this is charged by the dynamo during the periods in which the train is travelling at 25 miles per hour or more.

The Prince as a Fretworker

It is interesting to note that during an informal visit to the British Industries Fair the Prince of Wales paid a visit to the stand of Messrs. Hobbies Ltd., in the Toy Section. H.R.H. was attracted by the Fretwork model of the Quebec Bridge, and also displayed much interest in the Model Launches that were running in a tank of water with realistic effect. In his usual thorough-going manner, the Prince noticed the latest O.K. Fret Machine produced by Hobbies, and was not satisfied until he had treadled it. The manner in which he accomplished this proved that he had had previous experience, due we learn, to being the possessor in his early days of one of Hobbies Fretwork Machines. The high quality and excellent appearance and finish of the tools and various appliances on the Stand came in for remark by His Royal Highness, who also chatted with the assistants in charge of the Stand before he departed.



MECCANO

is always new. It brings a new interest into your life from the start. You become at once an engineer, a builder, an electrician, an architect, a motor mechanic, an airman, a weaver, and a shipwright. Through the long winter evenings it teaches you to solve intricate problems, and to think *constructively*. Whilst giving you endless hours of pleasure, it is the while training eye and hand and brain—all the time keeping them tuned up and fitting them for whatever career you may adopt later in life.

MECCANO IS ENGINEERING FOR BOYS

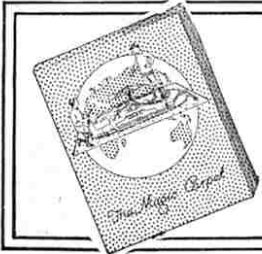

SEND FOR THIS FREE BOOK

"The Magic Carpet" is the name of this book that tells all about Meccano. It shows illustrations of all the Meccano Outfits, from No. 00 at 3/6 upwards to No. 7 at 3/70/-, and tells how the addition of each new part makes it possible to build several more models. It shows, too, some of the wonderful working models that can be built by the beginner. Write for this free book without delay. A postcard to Room No. 70, Meccano Ltd., Binns Road, Liverpool, will bring it by return post.

MECCANO LIMITED, BINNS ROAD, LIVERPOOL

FAMOUS BRIDGES—No. 9

RE-MODELLING A BRIDGE

Clearing the Channel of the Harlem River for Navigation

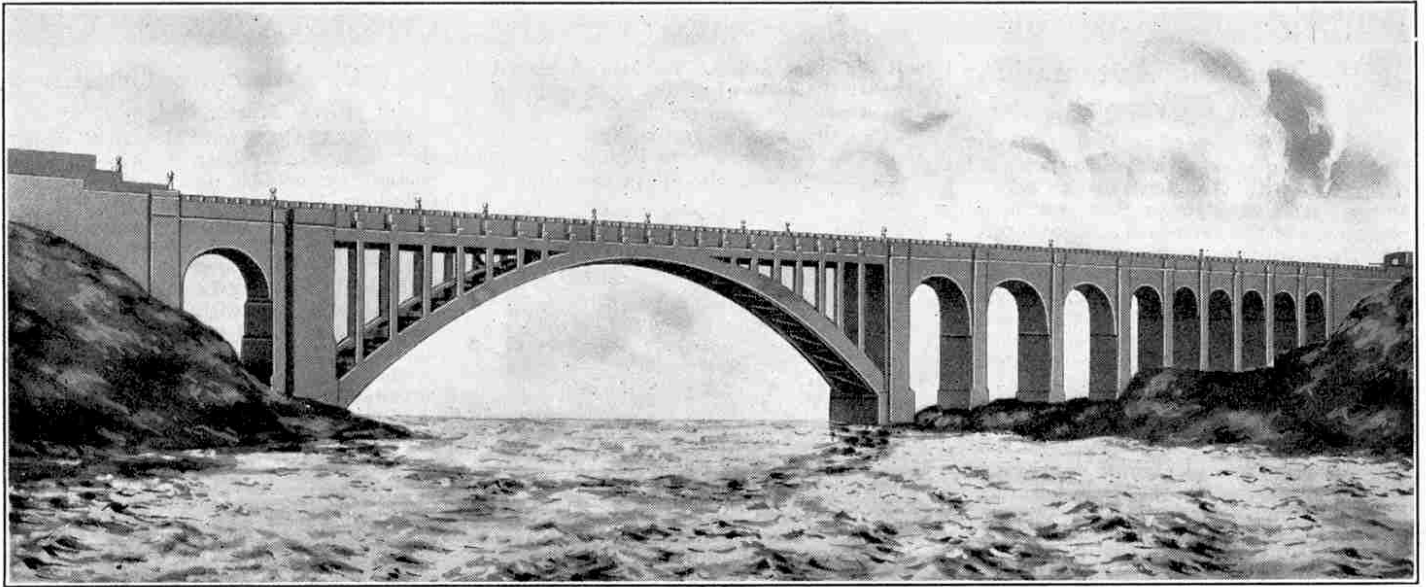

High Bridge, New York, as it will appear when the masonry pillars are removed and the cantilever is substituted

IT will be remembered that in our August issue reference was made to the fact that High Bridge, New York, had been pronounced a menace to navigation and that plans were being considered for its reconstruction, as it was not desired to lose the bridge entirely.

For many years a hot controversy has raged round this bridge. One party advocated the demolition of the bridge on the grounds that it served no practical purpose and took up space of which better use could be made, that it was unsafe and that the masonry was crumbling away. The opposition fought for the retention of the bridge on account of its historical associations and its architectural beauty.

A happy compromise has been effected at last, however, by the decision to re-model the existing bridge in such a manner as to conform to the order issued by the War Department and yet at the same time retain part of the original structure.

The Municipal Art Commission has approved a plan for this work by which nine of the original arches on the Bronx side will be retained, while a steel cantilever arch spanning the entire stream will replace the arches and four stone pillars resting on the bed of Harlem River. This new arch will have a span of 420 ft. and a rise of 103 ft., leaving an unobstructed waterway.

In its new form the bridge will be a combination of a Roman aqueduct and a modern cantilever bridge. It might be thought that such a combination would be unsatisfactory from an artistic point of view, but this will not be the case. The combination will harmonise well with the architecture of the city as a whole, and

in addition the design will blend well with that of the adjoining Washington Bridge.

It may be mentioned that such combinations of old and new styles of architecture are by no means a novelty in New York where old structures have had to be modified in order to render them capable of fulfilling modern requirements. Foreign architects visiting New York frequently express surprise at this blending of old and new, but in most cases they admit that the result is effective and frequently impressive.

High Bridge, as mentioned in our August issue, was built in 1848 as part of the old Croton Aqueduct, and carries three mains with a water-carrying capacity of 90,000,000 gallons of water per day. This volume of water forms quite an important percentage of the city's supply, and as this could not be dispensed with, even for a few days, the reconstruction of the bridge will be carried out in such a manner that the flow of water through the aqueduct will not be interrupted at any time.

The final plans have given great satisfaction to the citizens of New York. In addition to retaining a good portion of the old bridge, of which they are very proud, a great saving has been effected. If the bridge had had to be entirely demolished—in itself an expensive operation—it would have been necessary, in order to secure the city's water supply, to drive a tunnel under the river to carry the water that now flows in the aqueduct on the top of the bridge. The actual saving is estimated at about £200,000, a very considerable sum even to a great city like New York.

(Continued on page 266)

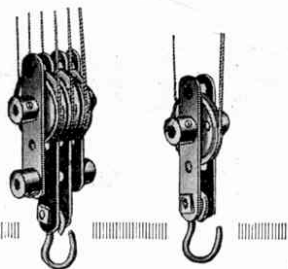

Meccano Pulley Blocks

Suggestions Section

Edited by "Spanner"

(29)—Meccano Automatic Speed Governor

Fig. 29 shows a speed regulating device that may be used with advantage in connection with the Meccano Clockwork Motor. It is based upon the centrifugal principle, and the apparatus is so arranged that the revolving weights, tending to fly outward, are brought to bear upon the inner surface of a Wheel Flange, the friction so produced checking the speed of the Motor. Incidentally, this type of governor is similar to that already fitted to Meccano Clockwork Motors and Hornby Trains, although built on a much larger scale.

Actual tests carried out with the governor fitted to a Clockwork Motor yield varying results, since the period during which a Motor will continue to operate at a single winding largely depends upon the amount of service that it has given, for a Meccano Clockwork Motor will run longer and more freely after it has been in use for some time. However, it is safe to say that the governor will increase the running time of the Motor by 25% or 33½% with very little waste of power. The advantages obtainable from such an arrangement applied to any model where it is desired to overcome a tendency to "race" are obvious.

Details of Construction

Its construction is quite simple, as will be seen. A Bush Wheel 1 (Figs. 29 and 29a) is secured to a shaft 2, which is driven from the main Motor spindle by means of the 57-teeth Gear Wheel and ¼" Pinion shown. Two 1½" Strips 3 are mounted on Pivot Bolts secured in opposite holes of the Bush Wheel, and are spaced at the correct distance from the wheel by means of a Collar (without set screw) and Washer placed on each bolt.

The weights consist of two ½" Pulleys 5 secured by their set-screws to the shanks of ⅛" Bolts passed through the outer ends of the Strips 3, sufficient play being allowed to permit of their free rotation.

When stationary, the 1½" Strips are drawn together by a small piece of Spring Cord 4 (Fig. 29a) secured to the centre of each by a nut and bolt. A Wheel Flange 6, bolted to a Bush Wheel mounted on a shaft 7, is placed in position so that its flange encompasses the weights 5. The shaft 7 is held rigidly in position by the set-screw of a Crank 8, which may be bolted to any

suitable framework 9. Washers are placed beneath the heads of the two bolts securing the Wheel Flange to the Bush Wheel, to prevent their shanks protruding too far in the interior of the Wheel Flange.

On the speed of the Motor exceeding a

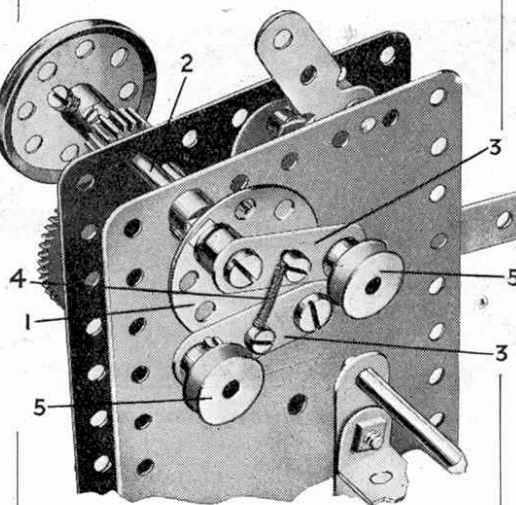

Fig. 29a

certain limit, the centrifugal force exerted by the weights 5 overcomes the Spring Cord 4 and the Pulleys move outward until they make contact with the inner surface of the Wheel Flange 6. This results in the retarding effect already mentioned.

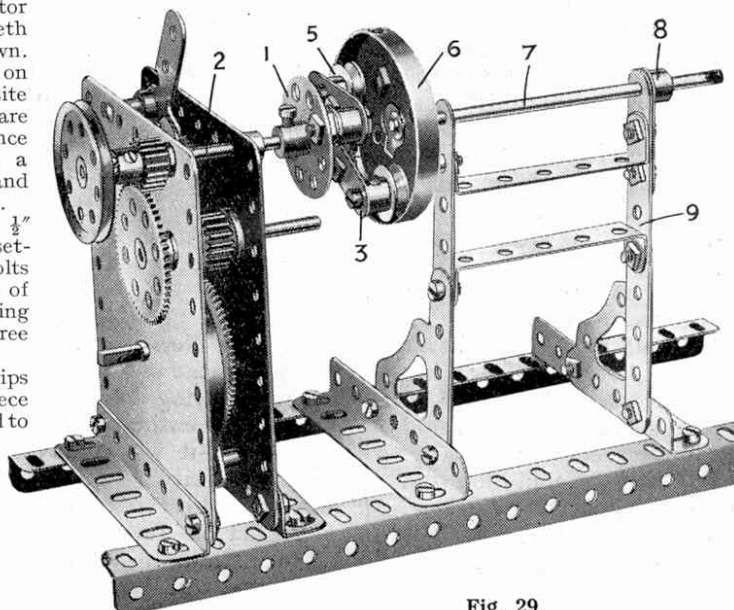

Fig. 29

(30)—Meccano Cramp

(G. S. Marsh, Blackpool)

Further to the several Meccano "tools" that have already been described in this Section, we are able now to reproduce an ingenious Meccano Cramp (Fig. 30).

Our contributor used this device in connection with Meccano model-building as well as for fretwork purposes. For example, in building the Stiff-Leg Derrick, he was able to dispense with the necessity of screwing the model to a wooden base by anchoring it to the edge of a table with two of these cramps. Again, often it is found advantageous to secure portions of a large model during construction to the table or bench at which one is working, and this is another purpose for which the cramp will be found extremely useful.

The model consists of a Threaded Rod (1) engaging the bore of a Threaded Crank (2) bolted to a 2½" x 1½" Double Angle Strip 3. A Threaded Boss 4 is mounted on the end of the Rod 1 and locked in position by a nut 5. A 1½" Contrate Wheel, with set-screw removed, is inserted on the small portion of the Threaded Rod protruding through the Boss 4; the teeth of the wheel grip the bench when the Threaded Rod is rotated. A second Threaded Crank 6, bolted to a 2½" Strip to form a handle, is mounted on the other end of the Threaded Rod 1, and is locked in position by a nut on either side.

For heavier work, it may be found advisable to substitute a frame built up from short Angle Girders in place of the Double Angle Strip, for a more secure grip could then be obtained.

(31)—Brake Attachment for Hornby Rails

(H. R. Hadden, West Moors, Dorset, and J. Hardy, Burnley)

Two competitors have submitted suggestions for a simple brake-rail for use with Hornby Trains. It consists of an Angle Bracket loosely bolted to the hole in the centre of one of the rail sleepers (Fig. 31).

The Angle Bracket should be bolted with its longest arm in a vertical position, ready to engage the small projecting lever on the Hornby loco which brings the brake into operation. The train may be allowed to pass unaffected by turning the bracket sideways—that is, with its edge towards the locomotive.

Our contributors claim that the chief advantage to be obtained from this idea is the fact that it may be fixed easily and quickly in any desired position in the layout, such as before points, signals, platforms, etc. A few trials should be carried out to test the efficiency of the attachment and it will probably be found that improved working is obtained by bending the bracket so that it presents an obtuse angle to the locomotive.

(32)—Automatic Train Indicator

(L. Driscoll and D. Currie, Manchester)

We have received from the above contributors two similar suggestions for an arrangement by which a station-bell, fog-signal, or like device, may be set in motion, or lamps lit, when a Hornby Train passes some predetermined spot in the track layout. The device is operated by an electric battery or accumulator and the simple connections required are as follows.

A wire connects one battery terminal to one terminal of the bell, buzzer or whatever apparatus is used. The second terminal on the latter is connected to a wire making contact with the metal rails, whilst a wire from the other battery terminal passes under one of the sleepers in the track, and its end, stripped bare, projects upward between the rails. It is important to see that this wire does not make electrical contact with the rail. The train brushes against the bare wire in passing and the circuit is completed, since the current passes through the train to the rails.

Many other suggestions are to hand concerning electrical signalling systems and these will be carefully examined and published, if suitable, in this section.

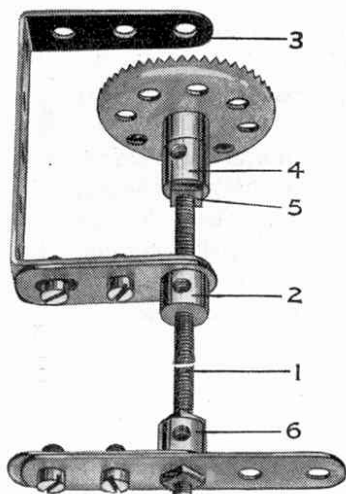

Fig. 30

(33)—Small Rubber Tyres

(H. Witherall, Weston-super-Mare)

In several models of motor-cars, etc., built with Outfits Nos. 2 and 3, Flanged Wheels are employed for the road wheels, and our contributor points out that the small rubber rings found on sewing machines form very satisfactory "tyres" for use in connection with these models.

The rings are placed on the wheel flanges and held in position by 1½" Strips mounted on the axle and pressed tightly against the wheels by means of Collars and set-screws. The rings may be obtained for a few pence each at all sewing machine depots.

(34)—Anchorage for Telpher Span

(H. Harris, Birtley, Co. Durham)

Many of our readers whilst constructing the Telpher Span (see Models Nos. 36 and 108 in the complete Manual), probably have experienced some difficulty in finding a suitable point at which to secure the pulley bracket and end of the guiding

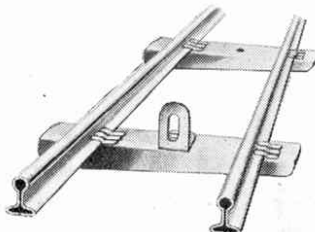

Fig. 31

cord in this model, for it is not always an easy matter to obtain permission to screw them in the middle of a nicely decorated wall! Master Harris has solved this little problem in a most interesting manner, however, and at the same time has evolved a method that enables one to assemble or dismantle the model in the space of a few moments.

The device consists of an Axle Rod 1 passed through the keyhole in the lock of door, as shown in the diagram, Fig. 34, and clamped tightly in position by a Bush Wheel 2 on one side of the door and a 1" Pulley with set-screw 3 on the other. The guiding cord, on which the trolley or travelling bucket runs, is tied to an Angle Bracket 4 bolted in the lower hole of the Bush Wheel, while the operating cord is led round a 1" Pulley 5 mounted on a short Rod journalled in the Cranked Bent Strip 6. The latter is secured very rigidly to the Bush Wheel.

The main portion of the model should be screwed, if possible, to the floor or table, or heavily weighted in order to withstand the strain on the cords.

(35)—Right-Angle Drive

(G. Wilcox, Broadstone)

George Wilcox suggests that shafts rotating at right-angles to one another may be coupled together by means of two Bush Wheels and a few nuts and bolts. The latter are bolted to the Bush Wheels, one in every hole, and the wheels are mounted on the shafts so that the shanks of the bolts intermesh. In several cases this contrivance may be used in place of Bevel Gears.

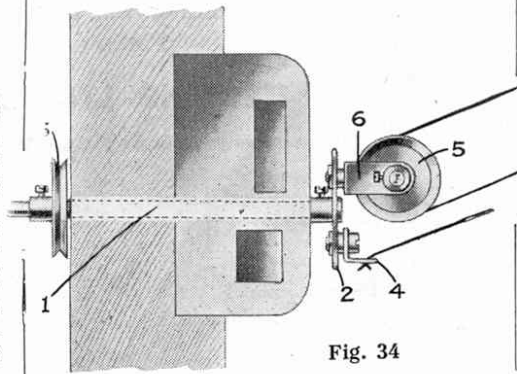

Fig. 34

(36)—Accumulator Carrier made with Meccano

(J. Heap, Heywood, Lancs., and C. F. Chell, Wolverhampton)

An accumulator has always proved a troublesome article to carry, on account of its weight and the danger of spilling acid upon one's clothes. Two contributors submit ideas for an easily made device, however, that will overcome these difficulties to a large extent.

The apparatus consists of a base built up from short Angle Girders, or other parts, to the necessary size. Strips 2 are pivotly mounted at each corner on Axle Rods passed through the base, and are connected to the upper Strips 3, the joints consisting of Rods 4. The length of the Strips 2 and 3 depends upon the size of the accumulator to be accommodated.

The handles are formed by Axle Rods 5 passed through the ends of the Strips. A more comfortable grip will be obtained by placing lengths of rubber tubing 6 on the Rods, or better still, by using round wooden pegs in their place.

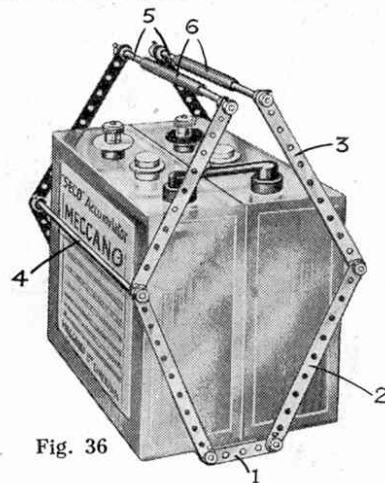

Fig. 36

It is interesting to note that Mr. Heap was awarded first prize for his idea in a "Wireless Accessories" Competition in the "Manchester Evening Chronicle."

(37)—Miniature Concrete Blocks

(R. H. Tresise, Burton-on-Trent)

Miniature concrete blocks will add considerably to the fun that may be obtained from such models as "Titan" cranes, and will serve admirably as ballast in loading Hornby goods wagons. They may be made by mixing together a little sand, cement, and water, and moulding in tins or match-boxes.

This Month's Awards

Five shillings will be awarded to each of the contributors concerned for Suggestions Nos. 30, 34, and 36 (two awards); whilst the senders of Nos. 31, 32, 33, 35, and 37 will each be presented with a Certificate of Merit, together with a complimentary copy of "Meccano Standard Mechanisms."

Replies to suggestions concerning Meccano and Hornby Train improvements appear on page 263.

MECCANO ACCESSORY PARTS

Plates

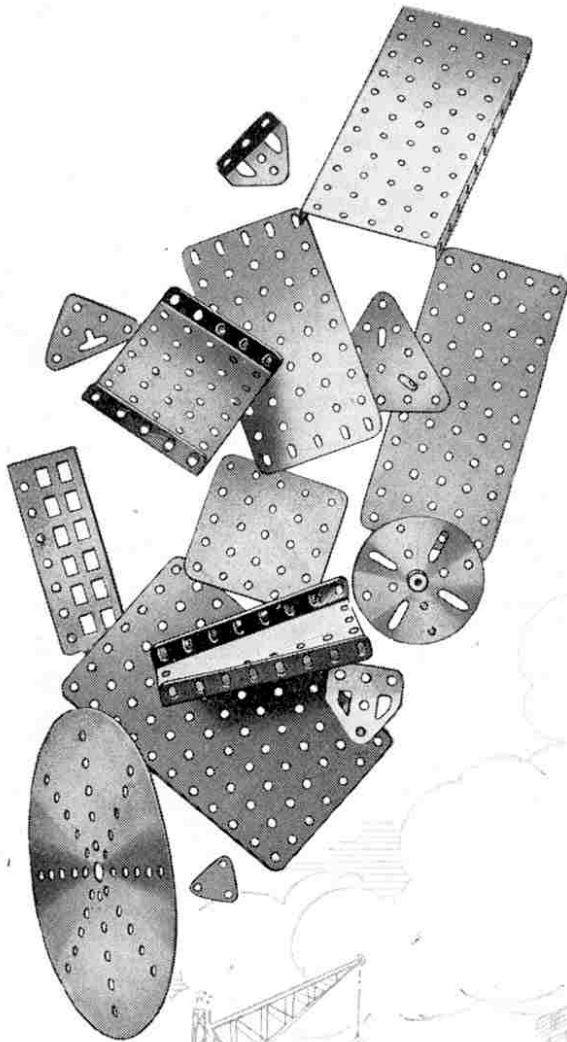

THE manufacture of steel plates in actual practice has been brought to a wonderful pitch of perfection.

This is due chiefly to the fact that the amazing evolution of armaments—which reached its climax during the Great War—necessitated the constant production of plates of sufficient toughness to afford some measure of protection for warships, forts, tanks, etc., against the terrible and ever increasing power of enemy armour-piercing projectiles and high-explosive shells. New inventions and improved methods of preparing and rolling the metal followed each other in quick succession, until to-day it is possible to produce steel plates of huge dimensions and strength.

Now that more peaceful times prevail, the improvements in steel plate manufacture are showing their merits in the construction of engines, boilers, ships, bridges, and similar structures.

Meccano plates, like their prototypes in real engineering, are made of the finest steel only, and are highly polished, with smooth rounded edges and corners. The holes are punched cleanly and accurately and arranged according to the Meccano equidistant system, which enables the plates to be incorporated in any kind of model and used for a thousand and one different purposes.

		s.	d.
52.	Perforated Flanged Plates, $5\frac{1}{2}'' \times 2\frac{1}{2}''$, $\frac{1}{2}''$ Flanges	each	0 5
52a.	Flat Plates, $5\frac{1}{2}'' \times 3\frac{1}{2}''$...	0 5
53.	Perforated Flanged Plates, $3\frac{1}{2}'' \times 2\frac{1}{2}''$, $\frac{1}{2}''$ Flanges	...	0 3
53a.	Flat Plates, $4\frac{1}{2}'' \times 2\frac{1}{2}''$...	0 3
54.	Perforated Flanged Sector Plates...	...	0 3
61.	Windmill Sails	...	0 2
70.	Flat Plates, $5\frac{1}{2}'' \times 2\frac{1}{2}''$...	0 3
72.	" " $2\frac{3}{4}'' \times 2\frac{1}{2}''$...	0 2
76.	Triangular Plates, $2\frac{1}{2}''$...	0 2
77.	" " $1''$...	0 1
109.	Face Plates, $2\frac{1}{2}''$ diam., with centre boss and set screw	...	0 4
118.	Hub Discs, $5\frac{1}{2}''$ diam.	...	1 3
126.	Trunnions, $1''$ deep, $\frac{3}{4}''$ flange	...	0 3
126a.	Flat Trunnions, $1\frac{1}{2}'' \times 1\frac{1}{2}''$...	0 2
133.	Corner Brackets	...	0 3
145.	Circular Strips, $7''$ diam. over all	...	1 0
146.	" " Plates, $6''$...	1 3

Your dealer will be pleased to show you all the Meccano Parts. Ask him for a complete list.

MECCANO LTD., BINNS ROAD, LIVERPOOL

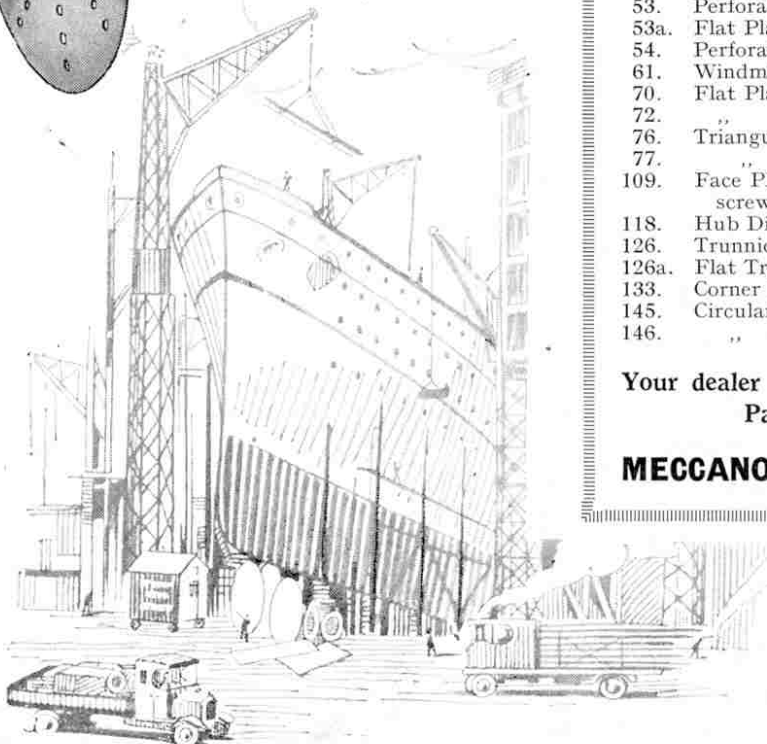

In Reply

In these columns we reply to suggestions regarding improvements or additions to the Meccano and Hornby Train systems. We receive many hundreds of such suggestions every week, and consequently we are able to publish only ideas that show particular interest or ingenuity. Every idea, however, whether acknowledged in these columns or not, is carefully examined and considered. It would be of great assistance if readers, when submitting suggestions for consideration, would write them on separate sheets of paper and include their name and address on the back of each sheet used.

Suggested Meccano Improvements

MECCANO MAGAZINE ANNUAL.—Your suggestion that we should publish a Magazine "Annual" at Xmas each year is interesting, but its compilation would occupy too much time, we fear! As it is, the publication of our big Christmas numbers keeps us very busy indeed! (Reply to W. Ahon, Melbourne).

Suggested New Meccano Parts

IMPROVED WHEEL BOSSES.—It has frequently been suggested that the bosses of wheels and similar parts should be tapped on opposite sides to receive two set-screws, and the matter has received our constant notice. We have always found that a sufficiently powerful grip can be obtained with the single set-screw; the advisability of effecting the alteration in some of the larger wheels, however, will be tested further. (Reply to C. W. Beese, Hamilton, Ont.)

SLEEVE COUPLING AND 1" PIVOT BOLT.—Your suggestion for a "sleeve" coupling, designed to enable two wheels to revolve as a single unit about a common axle, is interesting and is being examined. The possible introduction of an improved Pivot Bolt, 1" in length, is receiving our attention also. (Reply to C. W. Beese, Hamilton, Ont.)

WINDING DRUM.—A winding drum of the dimensions specified may be constructed from Double Angle Strips bolted between two 3" Pulley Wheels. The grooves of the latter may be used to receive the brake bands. (Reply to W. Wilby, High Hold, Co. Durham).

STEAM ENGINE PARTS.—See our remarks under this heading in the January "M.M." (Reply to J. Little, Bristol, and others).

IMPROVED STRIP COUPLING.—It was certainly a good idea on the part of your friend to drill a hole in the split end of a Strip Coupling to connect with its existing longitudinal bore, so that either a Rod or a Strip might be secured in that end. We have made a note of this. (Reply to H. J. Gunner, Wallington).

RAIL CONNECTIONS.—Your suggested peg attachment, with corresponding socket, to connect rails built with Meccano to the existing Hornby track is interesting and will be considered further. (Reply to W. V. Awdry, Box, Wilts.).

1" DOUBLE BRACKET.—The proposed Double Bracket, to measure 1" x 1" will be borne in mind. Hitherto we have found little demand for such a part, however. (Reply to C. W. Beese, Hamilton, Ont.)

LETTERING MECCANO MODELS.—The idea of attaching letters to models, such as "L.N.E.R.," "G.W.R.," etc., is interesting, but we doubt whether they are required often enough to warrant their inclusion as special Meccano parts. (Reply to David Floyd, Swindon).

BOILER.—We note your suggestions for a Meccano boiler, curved girders, etc. The addition of such parts has occupied our attention for some time past; it is difficult however, to standardise them with the present system so that they may be used in the greatest possible number of models or movements. (Reply to C. Hood, Taunton, and H. Henshaw, Bolton).

COMPRESSION SPRINGS.—The introduction of compression springs is under consideration. Small springs of this type are included in the Spring Buffer (Part No. 120A) already. We regret your suggested addition to the Crankshaft is not practicable. (Reply to H. Fox, Christchurch, N.Z.)

NEW FORK PIECE.—We are testing the practicability of a Fork Piece with 1" sides (two holes). (Reply to F. Franklin, London, N.15).

GROOVED RODS.—We fear the diameter of Meccano Axle Rods is too small to permit the cutting of a groove and the successful operation of sliding gear changes, etc., by this method. We have other devices in hand, however, with which to obtain a similar movement. (Reply to H. Teall, London, S.W.9, and H. C. van Doorn, Utrecht).

Suggested Hornby Improvements

COUPLED WHEELS IN No. 1 LOCOS.—The suggestion that the driving wheels of No. 1 locos should be coupled will come up for review later. (Reply to V. G. Eckersall, Prestwich, and many others.)

TERMINAL STATION.—Further to our statement under this heading in the January "M.M.," we hope to announce shortly a new device with which it is possible to convert the present "Windsor" Station into a terminus. (Reply to K. B. Mathews, Eastbourne, C. and W. Booth, Burnley, and many others.)

DOUBLE RAILS.—We have devoted considerable attention to the design of parallel track. Your

roofs, tunnels, etc., and perforated to receive Meccano nuts and bolts, with which various accessories for the Hornby system may be constructed. This is novel, but we fear scarcely practicable, although the idea will be borne in mind. (Reply to C. & W. Booth, Burnley).

DISTANT CONTROL OF SIGNALS.—We are carrying out a number of experiments in regard to the operation of Hornby signals from the signal-boxes and various points in the track, and hope to announce further details shortly. (Reply to L. T. Smith, Norwood).

SHUNTING SIGNALS.—We shall consider the introduction of shunting signals of various types. (Reply to C. Hare, Southport).

LOW VOLTAGE ELECTRIC TRAINS.—We are experimenting with Hornby Trains operated from a current of 4-6 volts. Watch these pages for future developments. (Reply to Eric Pardoe, Croydon).

TRAIN INDICATOR.—See our reply under this heading in the "M.M." for December 1925. (Reply to John Begg, Glasgow).

ARTICULATED ROLLING-STOCK.—See our reply to this suggestion in last month's "M.M." (Reply to Michael Denton, Guildford).

ENGINE SHEDS.—The question of introducing these accessories has been under consideration for some time past and we hope to announce the results of our experiments shortly. (Reply to Miss M. Quennell, London, N.W.5; F. C. Smith, London, N.15; D. F. E. Nash, Sutton; D. T. Felstead, Burton-on-Trent; M. Watkins, Liverpool; R. Coverdale, Hornsea; A. W. Cockman, London, N.12; A. Hodgkinson, Fleetwood; M. Chalmers, J. Paton and L. Anderson, Glasgow, and others).

4-6-0 LOCOS.—Further to our replies concerning suggested new locos, we have received a number of letters pointing out that 4-6-0 locos, 0-6-0 tank engines, and other types may be adapted to run over our existing 0 gauge curves by deleting the flange of the centre pair of driving wheels. Although such a procedure would overcome the difficulty to a certain extent, we do not altogether favour it. The introduction of such locos, together with new curved rails of larger radius, would necessarily prove more expensive to Hornby enthusiasts, and we are inclined to adhere to the present to our existing popular types. The whole question, however, will be further examined from every aspect. (Reply to G. Lawson; and M. Wilcocks, Seascale; J. Treadgold, Hunt End; V. Overall, London, E.11; S. Towler, Mitcham; J. Broadhurst, Swansea; E. Berry, Cardiff; and many others).

CUTTINGS AND EMBANKMENTS.—We do not think there is sufficient demand as yet to justify the introduction

of Hornby cuttings and embankments. (Reply to C. Herbert Lea, Moseley, Birmingham, and J. Marshall, London, S.E.18).

METROPOLITAN AND SOUTHERN COLOURS.—We note your suggestions that the No. 2 Tank Locomotives should be supplied in Metropolitan colours and that all rolling-stock should be obtainable in the Southern Railway livery. These suggestions have been marked down for review later. (Reply to J. Taylor, Hounslow; G. W. Clarke, Sudbury; J. Smyth Wood, London, S.W.4; L. Peavot, London, N.W.2; R. A. O. Brazier, London, S.E. 24; and others).

OVERHEAD WIRE FOR ELECTRIC TRAINS.—See our remarks on this subject in the February "M.M." (Reply to G. W. Clarke, Sudbury).

GUIDE TO THE HORNBY SYSTEM.—The series of articles printed in the "M.M." some time ago under the title of "How to Run a Miniature Railway System" will be incorporated in a booklet now in course of preparation. This publication will contain, in addition, a quantity of valuable information concerning the latest Hornby additions and improvements, and should prove of considerable assistance to readers who wish to derive the greatest possible amount of fun and instruction from their model railways. (Reply to T. A. Roby, Wigan).

EIGHT-WHEELED TANK WAGON.—This type of vehicle is not very common on British railways, but we will give your idea due consideration. (Reply to J. Gilchrist, Hemel Hempstead).

ELECTRIC LEVEL CROSSING.—The question of introducing a special level crossing for use with electric trains is under consideration. (Reply to T. G. Pearce, Bath; A. S. Maulby, Lincoln; and A. Hodgkinson, Fleetwood).

Meccano and Agriculture

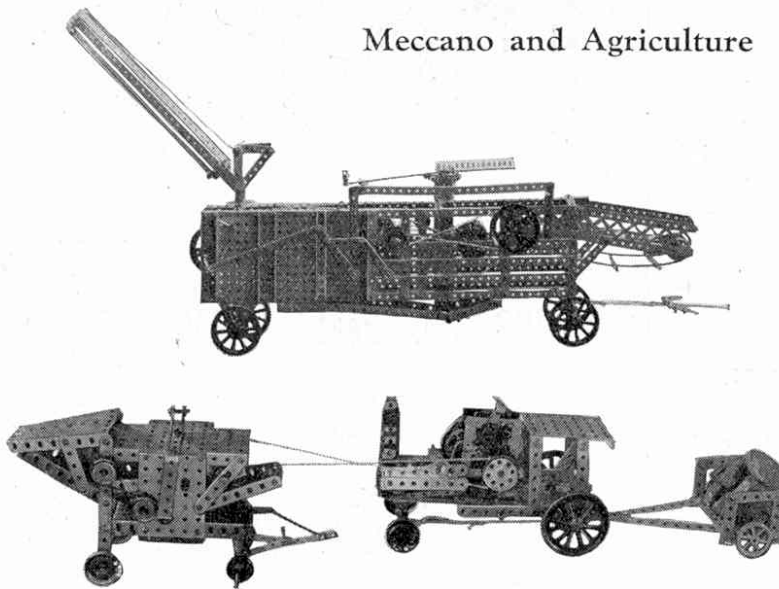

We illustrate two prize-winning entries in a recent Model-Building Competition, held in the United States, which form excellent examples of the capabilities of Meccano in reproducing modern agricultural machinery in model form. The threshing machine (top) was submitted by D. H. Riek, of Rhinelander, Wis., and is complete with feeder, straw carrier, shakers, grain conveyor, etc. A fan is fitted which in actual practice blows the straw through the blower shaft, or straw chute, for stacking purposes. All the operations are driven from a Meccano Clockwork Motor. The lower illustration shows a smaller threshing machine complete with tractor and tender, built by Robert Jensen of Nebraska. The necessary power for the operation of this model and for the propulsion of the tractor is obtained from the mechanism of an old alarm clock!

suggestion for double straight and curved rails is noted and will be examined carefully. (Reply to W. Close, Diss).

VIADUCT IMPROVEMENTS.—Your criticisms concerning the Hornby Viaduct are appreciated and will receive very careful attention. (Reply to A. D. Hill, Sheffield).

8-WHEELED WAGON.—There appears to be little demand for an eight-wheeled open mineral wagon, but we note your suggestion. Mail Van; see our reply under this heading in the January "M.M." Hornby trains may now be obtained lettered G.W.R. (Reply to J. Morris, Chateau d'Oex, Switzerland).

0-6-0 LOCOS AND COACHES.—We do not think locomotives and coaches with six wheels would possess any special advantages over our existing types, but we will bear your ideas in mind. (Reply to W. Close, Diss, and J. Morris, Chateau d'Oex, Switzerland).

CHECK RAILS.—We do not consider that the addition of check rails to Hornby curves as a guard against derailments would be justified. Such accidents should be very rare, providing the track is carefully and securely laid. (Reply to L. Ison, Melbourne).

PLATELAYER'S HUTS, TROLLEYS, AND GRADIENT INDICATORS.—The introduction of these and similar accessories will come up for careful consideration later. (Reply to D. Jagger, Lightcliffe, A. V. Strong, Cardiff, G. Lawson and M. Wilcox, Seascale).

RACK RAILWAY.—The introduction of the rack system for use with steep gradients is scarcely suitable, and, we think, would meet with little demand. (Reply to O. Goodman, Croydon).

CONSTRUCTIONAL ACCESSORIES.—We note your suggestion for the introduction of enamelled plates, coloured to represent engine shed sides, station

STAMPS ON APPROVAL

THE Gibbons' approval sheets do not contain damaged or heavily cancelled stamps. Each specimen is in perfect condition, and the arrangement helps you in selecting those you require. This is the only satisfactory way to buy stamps, and remember, Stanley Gibbons' prices are always remarkably low. Write to-day for approval sheets, sent post free anywhere.

FREE.—Illustrated Lists, giving full particulars of Stamps and Albums.

STANLEY GIBBONS Ltd.
Dept. S.15, 391, Strand, London, W.C.2.

SPECIAL "GEM" STAMP CASE & SET OF 10 FRENCH OFFER. COLONIES.

For 30 days (Colonies, 60 days) we present this gift gratis to every Stamp Collector sending 1½d. for cost of postage. (Abroad, 2½d.)

Only one Gift allowed to each applicant, and cost of postage must be sent.

ASK FOR OUR PRICE LIST of Sets, Packets, Albums, etc. Gratis and Post Free anywhere.

ILLUSTRATED CATALOGUE AND GUIDE TO STAMP COLLECTING

42nd EDITION. 116 pages. Full of information and Bargains. Over 18,000 varieties listed in Single Stamps and Sets. Post free 6d.

Established 1880.

Errington & Martin Ltd., LONDON, E.9.

THE "WORLD" PARCELS OF UNSORTED STAMPS

Marvellous Value.

Every parcel is Guaranteed Unsorted and Unpicked, and contains stamps from every part of the World. Very few English. Many Good Stamps are to be found, and there is always the chance of a Real "Find" being made. For sheer value these cannot be beaten.

¼ lb. (about 2,500 stamps) 1/6; post free 1/10
1 lb. { " 5,000 " } 2/8; " 3/-
2 lb. { " 10,000 " } 4/6; " 5/-

PHILIP J. DYKE,
122, GLADSTONE ROAD, WIMBLEDON.

COMPLETE STAMP COLLECTOR'S OUTFIT FREE!

1. Metal Watermark Detector with printed instructions.
2. A superior Perforation Gauge.
3. A Duplicate Album.
4. Packet of best quality Stamp Mounts.
5. Packet of Transparent Envelopes with gummed flaps.
6. Packet of different Superior Stamps, catalogued over 4/-.

In order to circulate our Half Price Approvals and latest Bargain List, the above outfit will be sent Free to all genuine applicants for approvals enclosing 1½d. stamp for postage; mention Outfit.

HORACE MILLER & CO., WHITSTABLE, KENT.

SPECIAL CLEARANCE OFFER

of packets of British Colonials. Every packet guaranteed to contain 1,000 (all different) genuine, clean, and free from paper stamps.

As there are a limited number only, all orders will be taken in strict rotation.

Price 5/6 each (post free).

Cash with order, which will be refunded if packets not approved of.

JOHN JAMES COATES,
7, Dundonald Drive, Leigh-on-Sea. (Est. 1879).

FREE Diff. Stamps mostly unused.
Enclose addressed Envelope for Approvals.
AIR POST 50 ALL DIFFERENT 4/-
M. REGIND, 30, SWANAGE ROAD, SOUTHEND

A CORRECTION

Owing to an unfortunate error an advertisement of Mr. H. C. Watkins, Granville Road, Barnet, announcing a competition for stamp collectors, appeared in our February issue. This was wrongly inserted as the competition, which was announced in our December and January issues, had already closed. We understand that Mr. Watkins has advised applicants direct to this effect.

100 DIFFERENT STAMPS 2 TRIANGULAR STAMPS 24-page DUPLICATE ALBUM

An extraordinary offer: 100 different stamps from:—Japan, old Belgium (1893), long set Ukraine, U.S.A. (Washington), Austria (newspaper), Russian Army, old G.B. Set 10 rare stamps overprinted, old 40 all different unused. Fine set Hungary (reapers, birds, etc.) Also a very beautiful pair of "three-cornered" stamps and a useful 24 ruled page duplicate Album. **SEND NO MONEY. JUST A POSTCARD** and request this big parcel and approvals.

LISBURN & TOWNSEND, LONDON ROAD, LIVERPOOL

FREE THE ELM PACKET. 100 DIFFERENT FREE AND PERFORATION GAUGE FREE

The Elm Packet includes a fine set of **FRENCH COLONIALS** from Algeria, Guyane (ant eater), Soudan (Arab), Oubangui-Chari (leopard), Guadeloupe (view), Wallis and Futuna (bird), Reunion (map), Equatorial Africa (native). Set of 50 unused **GERMAN**, including Munich Exhibition, scarce high value large numerals, set of workers, Air Mails, Officials, high value Provisionals. Also Chili (Columbus), Poland (eagles), set of old G.B., British Colonials, etc., **ABSOLUTELY FREE TO GENUINE COLLECTORS REQUESTING APPROVALS.** Those sending 2d. for postage will receive set of Portuguese Colonials. Special offers. 50 diff. French Colonials, 6d.; 100 diff., 1/6; 25 diff. Turkey, 7d.
J. BURTON, 3, ELM BANK, WALTON BRECK ROAD, LIVERPOOL.

"1000 PACKET" 4¹/₂

A WONDERFUL OFFER FOR

The "1000" Packet contains 500 excellently assorted stamps, a COMPLETE SHEET OF 100 UNUSED (very useful for exchanging), a neat booklet (12 pages) for holding duplicates, 25 British Colonials, usually sold at 1½d.—1d. each, including new and obsolete issues, 375 Magic "Strip" Mounts which are three times as quick as the old-fashioned single ones, and my price list of stamp bargains.

In addition FREE Sets will be sent to those who send names and addresses of stamp collecting friends.

Postage 2½d. extra.
Abroad 6d. extra.

WATKINS (M. Dept.), GRANVILLE ROAD, BARNET, HERTS.

AEROPLANE FREE!!

Mint Set Airmails FREE to Genuine Approval Applicants. Send a POSTCARD NOW.

COLLINS,
12, CLEVEDON STREET, MOSTON, MANCHESTER.

107 Radio Packet Free

Containing Jamaica (pictorial), U.S.A., GERMAN SURCHARGE, Roumania, Nigeria, Belgium, Ceylon, Canada, Oceania, S. Africa, Jugo-Slavia, scarce MALTA King Edward 1d., India, Gold Coast, Mexico, and others, making 107 all different, to those sending a postcard requesting approvals.
R. ALCOCK, 13a, Clarence St., Cheltenham Spa.

SPECIAL OFFERS.

Postage Extra.

Union of South Africa, pictorial new issue, ½d. and 1d. Two Kinds. Set of 4 Price 3d.
Gt. Britain, K.G., 2/6 & 5/- " 2 " 6d.
India, K.G., high values, " 4 " 1/3
1, 2, 5 and 10 Rs. " " " " " " 1/3
Approval Selections of any country.
Latest Price List of Packets, Sets and Albums.
Post Free.

The Midland Stamp Co. Ltd., Leamington Spa.

3/6 COMPLETE SET FREE OF PICTORIALS

This beautiful complete set of very large Roumania Pictorials depicting the Queen weaving and bearing the motto "God guide our hand" (translated). Priced at 3/6, presented free to applicants for approvals. Send a Postcard Now.

F. J. HUTTON, Llancloudy, Llangarron, Herefordshire.

FREE! SCENIC PACKET FREE!

It contains only Twenty Different stamps, but there is no Neurope Trash. They are all good ones and include:—
6 Different Mozambique Company, depicting Native Village, African Native with trophy of Elephant Tusks, Field of Maize, Railway Train in E. Africa, Coat of Arms, etc.; Six Guatemala (Signing of Independence, Temple of Learning, Parrot, The National Palace, Statue of Columbus, the scarce 1 Peso stamp, etc.), Algeria (surcharge), Dahomey (gathering coconuts), Guinea (natives fording river), Madagascar (palanquin), Argentine (Pan-American Congress stamp), Costa Rica (statue of Juan Santamaria), Greece (Postage Due) and Hyderabad (Indian Native State). Twenty Fine Stamps in all. Free to you. Send 2d. for postage of my 60 p. Price List and 12 page list of Accessories (abroad 3d). Also Three Scarce Cochinchina Free To Responsible Approval Applicants. Write to-day to EDWARD SANDELL, 10-11, FETTER LANE, LONDON, E.C.4.

WHICH set will you have FREE!

R. WILKINSON, Provincial Buildings, COLWYN BAY

All genuine applicants for approvals can have any one of the following sets absolutely free:

- A. 14 Ukraine Pictorials, complete set.
- B. 20 Liechtenstein Pictorials, obsolete.
- C. 9 Dominicana Republic, all maps.
- D. 6 Large Crete, beautiful pictorials.
- E. 7 Fine Unused Roumania, portraits.
- F. 100 War, Revolution and Armistice.
- G. 18 Switzerland, a nice collection.

SEND A POSTCARD AND STATE LETTER AT SIDE OF SET REQUIRED.



108 GIANT PACKET FREE

All genuine applicants for approvals will receive this giant packet of Colonial and Foreign Stamps, all different, catalogued nearly 10/-, including War, Revolution and Peace issues, Surcharges, Pictorials, Maps, Portraits, Animals, Ships, Birds, etc., etc. Send a postcard only.

H. WATTERSON, 2, ELM BANK, WALTON BRECK ROAD, LIVERPOOL



Stamp Collecting

Minute Differences for Sharp Eyes

by R. Kay Gresswell

THERE is often considerable difference of opinion on the part of stamp collectors as to whether minute variations in stamps, such as are caused by retouching dies, etc., should or should not be included in a stamp collection. The matter is, of course, one for each collector to decide for himself, and while it may be advisable to ignore such varieties in general collections of the whole world or of large groups of countries, yet much of the joy in the hobby lies in searching for these slight variations.

tion Day the two stamps received many adverse criticisms from the public, chiefly owing to the blurred appearance of the whole design and the poor likeness of His Majesty, who was pictured three-quarter face. The white lines of the hair, beard and eye had been engraved so finely that under heavy inking they soon filled up and printed as a solid block of colour on the stamp.

Varieties of Georgian Stamps of Great Britain			
Die A.	Wmk. Imperial Crown	1d.,	1d.
Die B.	"	1d.,	1d.
Die B.	" simple Royal Cypher	1d.,	1d.
Improved types.	" Imperial Crown	1d.,	1d.
"	" simple Royal Cypher	1d.,	1d.
"	" multiple Royal "	1d.,	1d.
Present types.	" simple Royal "	1d.,	1d.
"	" multiple Royal "	1d.,	1d.
"	" " block Royal Cypher	1d.,	1d.

These original stamps were engraved by the Royal Mint and printed by Messrs. Harrison and Sons on paper watermarked

Our advice to any readers who may be hesitating about this matter is that they should collect at least one country in detail, taking into account all die varieties, variations in watermark, perforation and so on. The remainder of the collection may be dealt with on broader lines and small differences ignored if thought to be desirable.

with an Imperial Crown and perforated 15 x 14, although varieties are known to exist perforated 14 all round. The head was copied from a photograph chosen by His Majesty and the frames were designed by Sir Bertram Mackennal, A.R.A.



Fig. 1. Die A

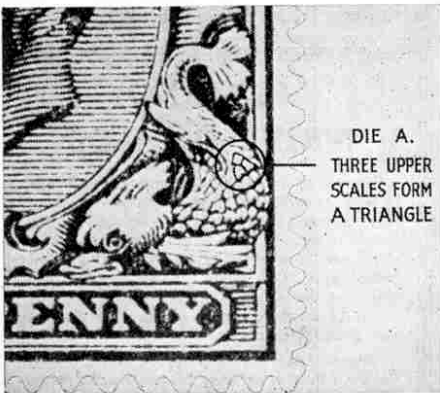

Fig. 2 New Type

Early Georgian Stamps of Great Britain

The 1/2d. and 1d. stamps (Figs. 1 and 6) issued throughout Great Britain at the beginning of the present reign from the Coronation Day, 22nd June 1911, to the end of 1912, form a very interesting series in regard to detailed differences.

Much of the blame naturally fell upon the printers, but it must be remembered when criticising them that they had had only about twelve months' experience of stamp printing and that they had no control over the choice of design, or the paper, or the engraving of the plates.



DIE A.
THREE UPPER
SCALES FORM
A TRIANGLE

Fig. 3. Enlargement of Halfpenny, Die A

Between these two dates these two values suffered a history of endless change in an endeavour on the part of the authorities to obtain a stamp that was satisfactory in design.

To reproduce a photograph by a line drawing satisfactorily requires a large number of fine lines and for this reason it is an unsuitable subject for a stamp design. The stamps were to be printed by surface printing, in which the design is printed by the raised lines of the plate. When the design consists of very fine lines, the spaces between them soon become clogged with ink thus

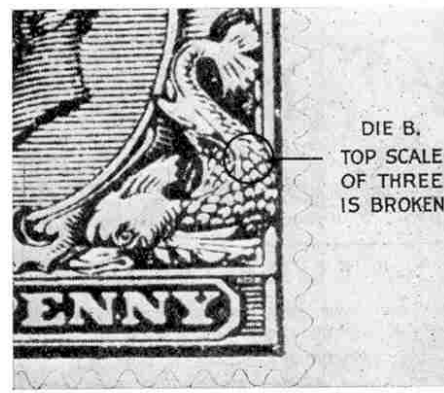

DIE B.
TOP SCALE
OF THREE
IS BROKEN

Fig. 4. Enlargement of Halfpenny, Die B

Public Disapprove New Stamps

When they were first issued on the Corona-

100 DIFFERENT Stamps free; send for 3d. approvals.—Cox, 135, Cambridge Road, Seven Kings.

STAMPS. 30 different for 6d., or will exchange. Apply—Green, Summerbell, Shanklin.

STAMP APPROVALS, 3d. each, 4d. in 1/- discount.—Charles King, 49, Motcombe, Dorset.

FREE. Albania, etc., request approvals. Postage 1 1/2d.—Mickleburgh, "Belmont," Rockleaze, Bristol.

FREE. 100 Stamps. Write for really cheap approvals.—H. J. Huggins, 22, Bramfield Rd., Battersea, S.W.11.

25 SOUTH AMERICAN FREE to approval applicants. Lowest prices.—S. Huckle, 53, Birkenhead Avenue, Kingston-on-Thames.

1,000 STAMPS 4d. Postage 1 1/2d. 1lb. mixture, approx. 6,000 stamps, 2/-; 1,000 unused 2/9. 100 different mint, 4 1/2d.—30, Rye Lane, Peckham, London.

FREE.—Fine set pictorial Mozambique and 100 varieties.—Postles, William Street, Cheetham Hill, Manchester.

25 UNUSED PORTUGUESE COLONIALS FREE to applicants for our famous "Oak" approvals.—Ensor, Cranleigh Road, Bournemouth.

FREE. Interesting Packet, grand set Rhodesia, 1 1/2d., with approvals. British Colonials from 3d., Gibbons. Foreign from 3d.—M., "Furze-Villa," Sydney Road, Haywards Heath.

FREE GIFT to applicants for Approvals. Breaking Collection.—Bignell, Heathfield, Hedgend, Hants.

QUANTITY OLD STAMPS, including Triangular Cape. In lots of 50, 1/-.—L. M. Bleasdale, West Gate, Warwick.

FREE GIFT to all asking approvals. 500 Foreign 1/-.—Purcell, Wykeham Park, Thame, Oxon.

STAMPS.—Collection going at 100 for 2/-, 250 for 4/6. No duplicates.—Box 404.

FREE
100 DIFFERENT unused, or 40 different Pictorials, or 15 Air Post to genuine approval applicants. Lowest Prices in Britain.
A. CLARKE, 2, CANNON STREET, DOVER.

FREE To Applicants for Approvals
9 PICT. MOZAMBIQUE or
6 NEW PICT. TOGO.
ALBAN SIMMONS, Hillside, NEW BARNET

FREE for One Month Only!
To every approval applicant sending 2d. stamp, 20 different, Unused (no German or Austrian). 100 different War and Armistice, 6d. post free.
A. Baxandall, St. Denis, Hauteville, Guernsey, C.I.

1,111 Try the Cheapest and Best 1,111
Method of adding to your collection.
When you buy PACKETS you buy DUPLICATES. I will send you a book of 1,111 different stamps from which you may select any 100 for 3/-. BUY ONLY THOSE YOU REQUIRE.
H. HARDY,
1,111 285, Archway Road, London, N.6. 1,111

THE AUTOMATIC PEA REPEATER
The most reliable pistol on the market. Takes 25 shots at one loading, best black finish, each in box with instructions and supply of ammunition, post free 2/3.
New model 17-shot Pea Repeater, black finish, post free 1/3.
R. DILNOT, 125, Chiswick High Rd., London, W.4.



MAKE GRAMOPHONES.
Our 64-page Catalogue tells you for 3d. how to do it and what accessories to choose. Motors in 25 sizes, from 9/-; Tone arms, 4/6; Speakers, 2/6; Headphones, 27/6 pair; Cabinets from 9/-; Gramophones from 30/-; Carr. paid.
The Regent Filings Co., D.78
120, Old St., London, E.C.1.
Established 21 years. Telephone: Clerkenwell 2923.

NATURE STUDY
Obtain your supplies of Books, Collecting Apparatus and Specimens from
WATKINS & DONCASTER, Dept. M.,
36, Strand, London, W.C.2. (P.O. Box 126).
Phone: Gerrard 9451. Full Catalogue Post Free.



Round the World

The pages of the "M.M." offer you a world-wide market. For a small charge of 10/- per column inch (2 1/4 inches wide), an advertisement is brought to the notice of thousands of potential customers each month. An advertisement in the "Meccano Magazine" will be read by over 100,000 readers in all parts of the world.

Rates for larger spaces on request.

Advertisement Manager,
"Meccano Magazine"
BINNS ROAD LIVERPOOL

An Indoor Aerial

Those of our readers who have electric light in the house and who are not able to fix an outside aerial for wireless reception can use the electric light wires as an aerial with great success. This is made possible by the Ducon adapter (manufactured by the Dubilier Condenser Co. Ltd., Victoria Road, N. Acton, London, W.3), which is plugged in to an ordinary lamp holder and is then connected to the aerial terminal of the set by a wire. There is no danger whatever from the house current reaching the set as each Ducon is tested at 2,500 volts before leaving the works.

The adapter consumes no current and does not effect the house light system in any way except that it is impossible to have an electric lamp in the same socket as the Ducon. This question only arises when it is dark and is, of course, immaterial where there is more than one lamp socket in the room.

There are a number of alternative methods by which the Ducon may be connected to the set, and these are fully explained in a booklet issued by the manufacturers. It is recommended that experiments be carried out, connecting the Ducon systematically in the manner described until the best result is obtained. Those who already have efficient outside aerials will find the Ducon useful for giving them a better earth connection. In this case the lead from the Ducon is taken to the earth terminal of the set and the makers claim that the efficiency of any set is increased by at least 25%.

We have tested out the Ducon and find that it gives all the results the makers claim. Whilst the efficiency of Ducon reception no doubt varies with the situation of each individual and the amount of wire in the house lighting circuit, we recommend any of our readers who have difficulty in fixing an aerial to experiment with the Ducon before finally deciding that it is impossible for them to have a wireless set. For instance, those who live in flats often find it is impossible to put up an aerial; others are unable to erect an aerial owing to some objection on the part of their landlord or neighbours. To such as these the Ducon has a special appeal, whilst those who already have efficient aerials are recommended to increase the efficiency of their sets by using the house wire system as an additional or separate earth. It should be mentioned, however, that the Ducon is not suitable for use with crystal sets.

Do It Now

If you've got a job to tackle,
Do it now.
Don't stand by and idly cackle
Do it now.
Do not leave it till to-morrow,
Or you'll rue it, to your sorrow.
Sound advice you now may borrow.
Do it now.

If entrusted with a mission,
Do it now.
If you've got an imposition,
Do it now.
Father Time is fleetly flying,
That's a fact there's no denying,
Never fail for want of trying.
Do it now.

If you want to fight your neighbour,
Do it now.
Things put off do lose their flavour,
Do it now.
Be as lively as a linnnet,
Do not say "just wait a minute."
When a job you see, begin it
Do it now.

A. REAY, in the *Whitehaven County School Magazine.*

A Rare "PENNY RED"

Most of the penny reds are catalogued at from about 2d. to 6d. each, used. After Plate 77 (a very scarce stamp) the next rarest is the last in the series, Plate 225, which is catalogued at 25/- used and 50/- unused. All the remainder are priced below 1/- with three exceptions. These are Plate 133, which is catalogued 1/- used and 20/- unused, Plate 219, catalogued 1/6 used and 3/6 unused, and Plate 223, catalogued 1/- used and 5/- unused. The 1d. rose red, Plate 116, imperforate, was issued at Cardiff and is catalogued £30, but you are not likely to come across any of these.

Stamp Collecting—(contd. from page 267)

Success at Last!

These two stamps, while a great improvement on any that had been issued before bearing the head of King George V. for use in this country, were by no means as striking or as pleasing as the stamps of an important country should be, and so in October 1912, the present one penny stamps were issued with an entirely new frame and with a side-view portrait.

This was a great improvement and in the following January (1913) there appeared the present halfpenny which was in the same frame as the previous halfpenny but with the new side-view head. Thus ended the long search for suitable low-value stamps for this country and stamp collectors have been provided by it with a very interesting album page. We advise all our readers to collect all the varieties of these stamps for they are very interesting and illustrate in a very full manner the difficulties that can be encountered when making a stamp.

Re-modelling a Bridge—

(Continued from page 259)

The new bridge will make the Harlem River more readily navigable. Owing to its many turns and obstructions this has never been a favourite route for ships or barges, but the clearing of the channel by removing the obstructing piers will make it possible to carry out such improvements as will provide a useful short cut from the Sound to the Hudson.

We are able to reproduce on page 259 a drawing showing how the bridge will appear when completed, and our readers will agree that the effect is very fine. It is interesting to compare this drawing with the illustration of the Washington Bridge on page 407 of the August "M.M." and to note how closely the general lines of this bridge have been followed in the new High Bridge design.

MECCANO WRITING PADS

These Writing Pads are becoming increasingly popular and most of the letters we receive from Meccano boys are written on the familiar tinted paper. The pads are supplied in two sizes, each consisting of 50 sheets of printed bank paper, with cover. They are just the thing to use when writing to your friends, for the special notepaper shows at once that you are a Meccano boy.

Prices—Large, 1/- each (post free); Small, 6d. each (post free), from Meccano Ltd., Binns Road, Liverpool.

giving a smudgy and blotchy appearance to the resulting work. This is what occurred in this case.

Attempted Improvements

The public opinion against these two stamps was so great that soon after they had been issued the printing plates were treated in a special manner so as to make the lines of the engraving deeper, in the hope that they would not then become filled with ink.

The stamps printed from the deepened plates may be distinguished from those from the originals owing to one or two small differences, and in order that our readers may be able to identify these varieties, we have specially prepared large illustrations of parts of these stamps so as to make quite plain the variations in detail. In both values the original die is referred to as Die A and the deepened die as Die B.

Difference in the Halfpenny Stamps

In the halfpenny value, part of the frame consists of two dolphins one on either side of the lower part of the design just above the word "halfpenny." The scales on the upper part of the body of the right-hand dolphin are in Die A in the form of a triangle, each scale being complete as shown in Fig. 3. In Die B the top scale of the three is broken, as is clearly shown in the second illustration (Fig. 4).

This is the most popular test for these two dies but there are many other variations that are often of assistance when the top scales are covered by a postmark. In the portion of the stamp shown in Fig. 3 and 4 it will be seen there are two "┌" shaped white lines one below the other forming part of the outer frame of the stamp. On comparing the two illustrations it will be seen that the end of the up-stroke is in every case pointed but that the shape of the points on those in Die A is quite different from the shape of those in Die B.

Other variations are: the fine lines of the lower part of the beard are blurred in Die A and clearer in Die B, and the eye is much more blotchy in the first die.

Dies A and B in the Penny

The one penny value has a very simple difference in the two dies. In Die A, the ribbon on the right-hand side of the crown has long shading lines, the second line from the crown extending unbroken from the top solid colour to the lower solid colour (see Fig. 5). In Die B this line is broken in the middle and the whole of the shading on the ribbon is in short lines (see Fig. 7). There are also other minor differences such as the pearls on the crown, which appear like a strand of rope in Die A and which are much more distinct and better formed in Die B.



Fig. 5. Enlargement of Die A, Penny



Fig. 6. Die A, Penny, showing "lean" lion



Fig. 7. Enlargement of Die B, Penny



Fig. 8. New Type Penny, showing touched-up lion

approval of the general public and it was probably on account of this that on the 1st January 1912, the authorities unexpectedly issued entirely new stamps of designs, which, although based upon the old, yet differed considerably with the intention of avoiding the previous defects. These new types are shown in Figs. 2 and 8 which should be compared with Figs. 1 and 6 respectively.

The new halfpenny type was not greatly different from the previous type. The same portrait was used for the King's head although the fine lines were now largely replaced by others wider spaced and therefore not so liable to become clogged with ink. In particular the parting of the hair, the eyes, the shading of the beard, the moustache, and the shading below the chin, are much clearer and lighter. The upturned points on the end of the moustache are now visible for the first time.

Concerning the frame, the design remained unaltered. The shading behind the "1/2" in each upper corner is now a series of parallel lines instead of a blur of solid or semi-solid colour as formerly. There is however one distinct alteration in the frame and it is by this that the two types may most easily be distinguished. In the first type (both Die A and B) there are two vertical curved lines of shading on the left side of the ornament between the dolphins' heads. In the new type these two lines have been united so that there is only one thick line as shown in Fig. 2 (the double line of the first type is shown in Fig. 1).

The new one penny type is noticeable in that the lion at the base is now shaded all over. Hitherto it had only been partially shaded and the few lines that were inserted had the unfortunate result of making the animal look very thin and hungry, so much so, in fact, that several newspapers published rude paragraphs inquiring who had been "starving the British Lion!" The shaded lion was a great improvement and put an end to this criticism.

Both these stamps were at first issued on paper watermarked Crown, but in August 1912 they appeared on the new simple Royal Cypher paper, and finally in December on the multiple Royal Cypher.

(Continued on page 268)

The
BRADFORD AGENCY
for Meccano Parts and
Hornby Trains
is
BROWN, MUFF
AND COMPANY LIMITED

We stock every part and send all orders carriage paid or post free in the United Kingdom.

BROWN, MUFF & CO. LTD., of BRADFORD

'Phone 2890 (6 lines)



BABY BETTY WON'T STOP

Apart from an electric fan we doubt if there is anything that moves quicker all over than does Baby Betty. Those tiny hands have the speed of a deer; there is more than the quickness of a flash in the leap to and fro of her eyes.

When we bought that camera we really thought we should be able to obtain a few records of baby's happy moods and poses. But she proved much too speedy for the film.

Then one day we bought a spool of Ilford Roll Film. Six perfect pictures! It was as though Baby had "held" the movement specially for the occasion. Surely a firm can claim to make the fastest film when they can take our baby?

INSIST ON

ILFORD ROLL FILM

THE BRITISH MADE FILM IN THE RED CARTON, IN SIZES TO FIT ALL ROLL-FILM CAMERAS AT POPULAR PRICES.
Obtainable from all Photographic Dealers.

ILFORD, Limited, ILFORD, London, England.



"Here and here did England help me: how can I help England?"—*Robert Browning.*

The best ROLL-FILM is English!

No. 1.

The Imperial Company is an excellent example of what old-time craftsmanship can achieve with a modern product under modern conditions. Imperial Roll-films and Film Packs possess exceptional capacity for giving bright, sparkling snapshots under almost all weather conditions—they are the simplest, fastest and most perfect on the market.

They are sold by all good photographic dealers at usual prices—V.P., 1/2; 2 1/2 x 3 1/4, 1/2; 2 1/2 x 4 1/4, 1/5—and fit all makes of cameras. Get a supply to-day of Imperial Roll-films—British and Best—and discover how easy and good your photography becomes.

British Product—British Workpeople—British Company.

IMPERIAL Roll Film and Film Packs

THE IMPERIAL
Cricklewood,

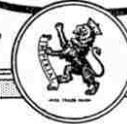

DRY PLATE CO. LTD.
London. N.W. 2.

**EVERY
Exposure
a
Perfect
Negative!**



CALL IT 'GAY-VERT'

YOU will get 6 perfect prints from every spool of the Gevaert Ultra-rapid film. No more "ghost" negatives or "flat" prints. Try it. Obtainable from all Photographic Dealers or sample spool sent post free for cash.

GEVAERT LTD.
Walmer Road
LONDON, W. 10

Gevaert

ROLL **ULTRA RAPID** FILMS

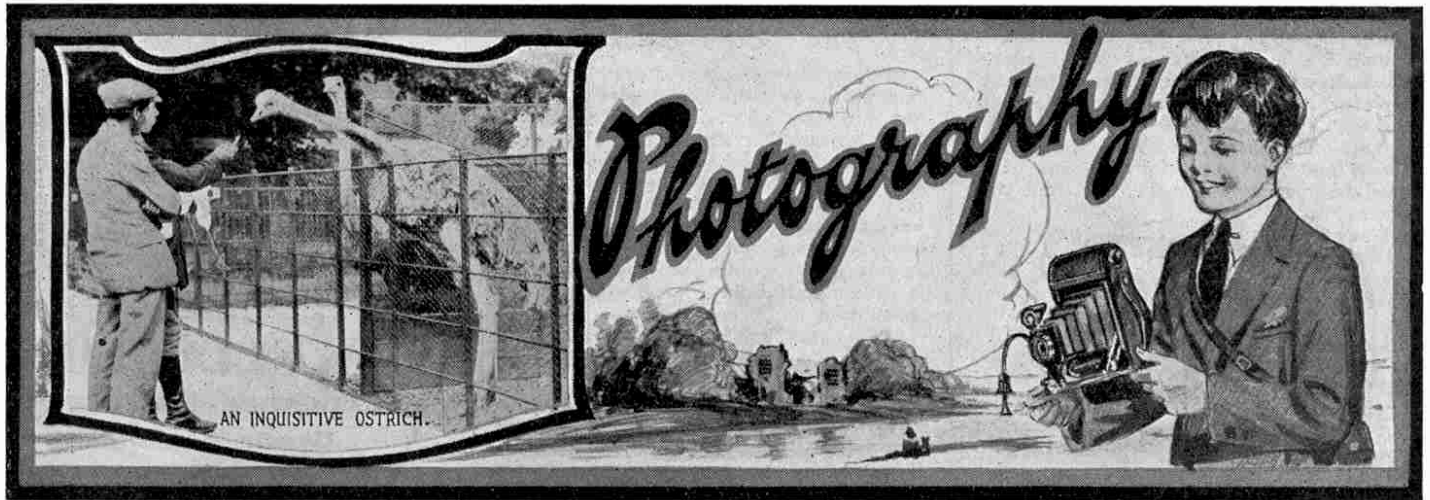

XIII. FLASHLIGHT PHOTOGRAPHY

FLASHLIGHT PHOTOGRAPHY differs in few respects from other forms of artificial light photography and the general rules regarding lighting and arrangement of the subject, which were described in last month's article, remain unchanged.

The intense brilliance of the light from flashpowder enables us to secure striking effects by instantaneous exposures in circumstances where any other source of light would involve a very long exposure, perhaps so long as to make success impossible. Among the most interesting branches of flashlight work are silhouettes and fireside effects.

How to Make Silhouettes

The operations involved in producing silhouette effects, of which a typical example was given last month, are quite simple. First of all, a white sheet is hung across the open door of a room so as to cover completely the opening. The sitter is then posed inside the room for a profile view and the camera, which is also inside the room, is carefully focussed in order to obtain a perfectly sharp outline. When all is ready the light in the room is turned down, the shutter is opened, and an assistant outside the room ignites, say, 50 grains of flash powder. The flash illuminates the sheet and the result is a photograph showing a background of white with a black silhouette of the sitter whose figure comes between the lighted sheet and the camera.

Picturesque Fireside Effects

Fireside pictures are among the most popular forms of flashlight work and they present little difficulty in the making. The most effective results are produced by grouping two or three friends in a natural manner around the fireside, one person sitting directly in the line of view from the camera to the fire in order to shield the lens from the direct glare of the flash. The flashpowder, 50 grains at F11, should be placed on thin paper and rolled into a ball ready to be thrown

into the fire at the proper moment. Focussing is done with the room lights full on and then, when everything is ready, the shutter is opened and the powder ball is thrown into a red hollow in the fire. Provided that the grouping is natural the results obtained in this manner are artistic and interesting.

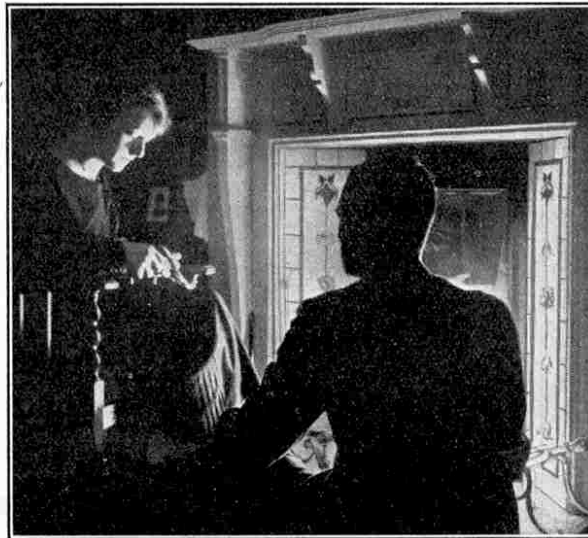

A Typical Fireside Effect

Many readers who attempt fireside studies will probably feel the necessity of obtaining a more realistic effect than is afforded by the blue-black tones of gaslight or bromide papers. A great improvement in this respect may be brought about by the use of a suitable red stain which gives more or less the ruddy effect of fire-light. There is no difficulty whatever in the staining process. Supposing, for instance, we select for the purpose the "Soloid" red stain manufactured by Messrs. Burroughs, Wellcome & Co., all that we have to do is to take the prints from the washing water, remove the excess moisture, and place them in a solution

of the stain for a few minutes, afterwards rinsing them in running water for a few seconds and drying in the ordinary way. The strength of the colour may be varied by using stronger or weaker solutions. Many photographers denounce strongly the use of colours in photography but there is no possible objection in this instance, and probably everyone will admit that a black-and-white fireside scene is as unreal as a snow-scene printed in the warm brown colour of self-toning paper.

Practical Operations

Coming now to practical details, let us emphasize first of all that flashlight photography is not dangerous. The flash may possibly startle nervous people who do not understand how it is produced, but it is a fact that flashpowder is perfectly safe if ordinary common-sense precautions are observed in using it. Obviously it is unwise to stand too close to the flash or to have this take place close to curtains or inflammable material.

The only apparatus required other than a camera is a tin or old tray on which to place the flashpowder and a step ladder upon the top of which the tin is placed in order that the flash shall take place at the necessary height. We have mentioned that good effects may be obtained by the use of a muslin screen between the light and the sitter to act as a diffuser. Such a screen may be used effectively in flash-light portraiture but the precaution should be taken to damp the muslin beforehand, thus obviating all risk of fire.

The exposure is the next point to be considered. Knowing the size of the lens

stop and the speed of the plate or film, the only point to be decided is the quantity of powder to be used. Full instructions are given with all high-class brands of flashpowder and these instructions should be followed carefully. As a rough guide for experiment the exposure on a subject between 5 ft. to 8 ft. from the camera, using F/11 and a plate of 300 H. & D.—the average speed of films—might be taken as 50 grains. If the distance of the subject is increased from 8 ft. to 12 ft. 80 grains of powder will be required.

The flashpowder should be laid in a little heap on the tin or tray, and when all is ready the camera shutter should be opened and the powder ignited by means of a long taper or match fixed to the end of a stick.

A Meccano Flashlight Stand

We illustrate a very useful stand for flashlight work that can be easily made in Meccano. It has the advantage of enabling the photographer to operate it by means of a length of string and thus include himself in the photograph. The accompanying illustration gives a good idea of the construction of the stand and the parts required are as follows:—

4 of No. 2	2 of No. 20
1 " " 8	19 " " 39
2 " " 9	1 " " 52
4 " " 12	1 " " 54
1 " " 18A	1 " " 42
1 of No. 133	

The stand should be placed at a suitable height and it is best weighted down to prevent the possibility of its overbalancing when the string is pulled. The powder should be placed in a small tin on the powder stand. The action of pulling the string draws the weighted arm forward and brings the small piece of lighted taper or a lighted wax vesta in contact with the powder.

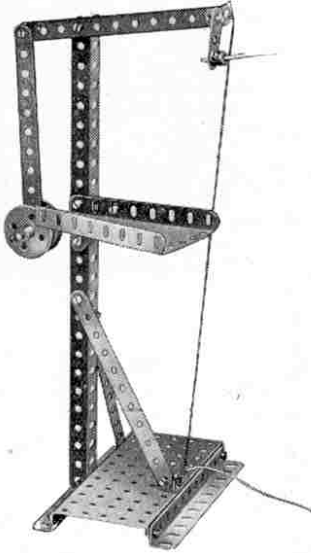

A Meccano Flashlight Stand, as described recently in "The Amateur Photographer"

The Coming Season

Serious photographers do not put their cameras away during the winter months but carry on photographic work of one kind or another throughout the year. This is not the case with the average amateur, however, and the popular season may be said to begin at Easter. This week-end thousands of cameras that have been lying idle perhaps for months will be brought into operation, and will remain in use off and on until late Autumn brings short days and waning light.

We should like all our photographic readers, as they charge their cameras for the first time this year with plates or films, to ask themselves the question: "How many successful photographs did I obtain last year out of all the exposures I made?" In many cases the reply must be—"Very few indeed!" The main cause of this large proportion of failures is to be found in one fault—under exposure. Over and over again we have watched beginners snapping away light-heartedly under conditions that made successful photography, with the apparatus they possessed, an impossibility.

In our photographic article next month we shall deal in detail with snapshot photography and show how easily success may be obtained if certain points are kept in mind. In the meantime we would point out that at this time of the year snapshots with the average camera demand bright sunlight or something closely approaching it.

Answers to Photographic Queries

CLEANING A LENS.—The safest method of cleaning a lens is to wipe it gently with a soft linen handkerchief that has been moistened with methylated spirit or water, but if the former is used care must be taken to prevent the spirit from reaching the cement between the lens glasses. (Reply to R. H. Newman, Swansea).

PERMITS TO PHOTOGRAPH.—We do not think that you will have difficulty in obtaining a permit to take photographs in and about the church you mention. Write to the Rector and explain your object. Our experience is that the authorities of any building or property are always willing to grant facilities to photographers when proper application is made beforehand. (Reply to R. S. Dixon, Chester).

POOR PRINTS.—It is impossible for us to give an opinion as to the cause of a poor print without having a specimen and when possible, the negative to examine. There are many causes of failure and their natures are widely varied. (Reply to S. H. Jackson, Edmonton).

STORAGE OF SENSITISED MATERIALS.—Sensitive materials, such as plates, films and printing paper, should be stored in a room that is free from damp, great heat or gas fumes. The last named is the greatest danger and when it is impossible to avoid a room lighted by gas, we recommend that the material be stored as far from the gas as possible and placed on a shelf near the floor. (Reply to E. S. Roberts, Belfast).

SILVER STAINS.—The negative is suffering from silver stain caused by coming into contact with a piece of printing paper when one or the other was in a damp condition. To remove the stain rub the negative with a pad of cotton wool bearing an abrasive preparation (a metal polish such as Globe is highly effective) for a few moments and then place the negative in a strong solution of hypo. The stain will disappear but, if very old, may take an hour or two in doing so. (Reply to R. S. Fletcher, Malta).

LENS VALUES.—Do not pay too much attention to the friend who says it is impossible to get good results with a cheap lens. It is not the lens but the man behind the camera who counts, and the careful photographer with a cheap lens will obtain better and more consistent results than the slipshod owner of an expensive lens. The sole difference between the large and the small, the expensive and the cheap lens, is that the former permits the taking of snapshots on days when the latter would be unusable, and under conditions when the cheap lens would be suitable for a "snap," the more expensive, by being stopped down, could secure a negative rather sharper in detail and therefore more suitable for enlarging. (Reply to J. R. Simpson, Dundee).

Photographers!

Start the season well

Price 1/6



Obtain a copy of this book
'WELLCOME'
Exposure Calculator
Handbook and Diary

Cuts out failures. Saves Money

All Photo Dealers

BURROUGHS WELLCOME & CO.
3, SNOW HILL BUILDINGS, E.C. 1
XX 4433

Write for free literature

COPYRIGHT

£50 a Month for Happy Snaps

23 Cash Prizes are offered each month in the ENSIGN Happy Snaps Competition. You need not be an expert to win one of the prizes. Full details in every carton of ENSIGN Speedy FILM. Buy a spool To-day.

FREE BOOKS about PHOTOGRAPHY

By sending a postcard now you can get interesting illustrated booklets that tell the story of snapshot taking. They show clearly and simply just how to take better snaps and how to judge between good prints and bad. They teach you more in a few minutes than you could learn by experience in months.

Write now—simply send your name and address on a postcard to ENSIGN HOUSE, Dept. E, 88-89, High Holborn, LONDON, W.C.1.

ENSIGN Cameras and FILM

are made in Great Britain. For picture-making qualities they have no equal. Ask your Dealer.

"MECCANO MAGAZINE" SPRING BACK BINDER



There is no better way of keeping your Magazines clean and tidy than by binding them in the special binder we supply for this purpose.

This binder has a strong stiff back, and holds a large number of copies. Covered in black imitation leather, tastefully tooled, lettered gold, its price is 3/- post free, from Meccano Ltd., Binns Road, Liverpool.

OUR BUSY INVENTORS

RECENT INTERESTING PATENTS

A Portable Electric Saw

One of the latest developments in electric tools is a six inch circular saw, embodying a right angle drive. The saw is driven by a universal motor run off either A.C. or D.C. circuits and its total weight is only 15 lb. complete. The outfit can thus very easily be carried for use to any part of a workshop or yard. A convenient form of hand grip, in which the make and break trigger is located, forms part of the set.

This portable saw will accomplish any of the work usually performed by a hand saw, but at a much greater speed. In addition to timber work, the saw will cut through light sheet metal, hard rubber, asbestos board and ebonite.

The motor rests on a flat plate which is placed on the face of the material to be cut and a shield is provided to prevent particles of dust flying about.

Unloaded, the saw attains a speed of 3,600 r.p.m.

* * * *

An Improved Condenser Dial

The Indigraph, recently placed on the market by the Igranic Electric Co., is a novel but highly efficient variant of the orthodox condenser dial. It consists of a dial cover fixed to the panel by two small projections that fit into holes drilled in the panel for this purpose.

The ordinary condenser knob is replaced by a knob carrying a graduated scale rotating beneath the fixed cover. In the cover two windows are provided to enable the scale to be read. Each window is provided with a standard point to facilitate registration of scale readings on the upper portion of the cover, whilst the lower point enables markings on the dial to be located for later reference. The use of this latter point is readily appreciated, for once a setting is made it can be repeated at any later time provided, of course, that the set itself remains unaltered. This useful fixed cover is manufactured in several sizes, the smaller being for potentiometer and rheostat and the larger for variometer and condenser.

* * * *

The Maco Template

One of the most ingenious labour saving engineering devices that it has been our pleasure to observe recently, is the Maco Patent Adjustable Template recently placed on the market. This Template or adjustable gauge (shown in Fig. 1 in its normal ready-for-use position) is composed of a number of very fine strips of hard drawn solid brass, each .007 in. in thickness. These fine strips, called laminations, are held in position by two specially constructed clamps, secured by two locking thumb screws and springs, the tension of which holds the laminations firmly as they adapt themselves to the exact contour of whatever object the gauge is pressed against. In Fig. 2 the Template is seen in use, taking a profile of a rail.

The uses of the Maco Template are almost boundless, and range from the

taking of rail and wheel tire profiles to making profiles of moulds for pottery. One of its great features is its extreme simplicity, it being possible for an unskilled user to handle it successfully and to obtain perfect results without fear of failure or damage to the instrument. The standard sizes are from two inches to twelve inches, and these should cover any normal need of the amateur mechanic,

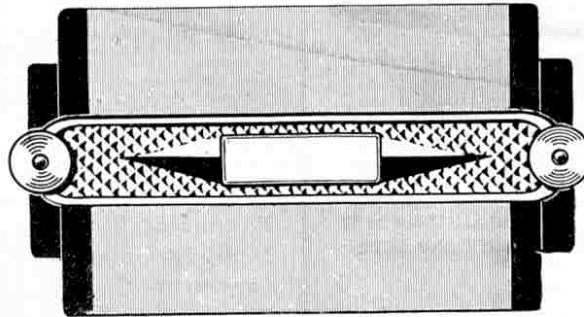

Fig. 1

but special sizes can be made on request. Those of our readers who in the past have struggled to make their own templates with clay, lead or Plasticine will appreciate our suggestion that, ere long, this type of template will find its way into every engineering workshop.

* * * *

Traffic Safety at Night

The ever increasing number of motor-cars upon the road has caused considerable

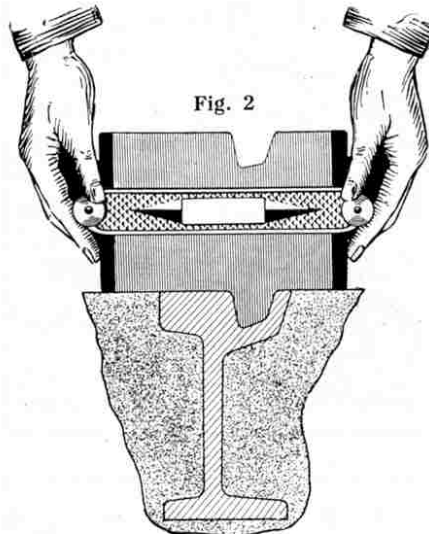

Fig. 2

brain racking in the attempt to overcome traffic dangers, more especially those arising after dusk.

The latest safety device consists of a phosphorescent arrow attached to the traffic controller's wrist at night and, as an approaching headlight flashes on to the arrow, a vivid green reflection is produced. The position of the arrow will indicate the direction in which the car may travel.

Another ingenious idea enables motor cars literally to peer round corners. This consists of two mirrors mounted at right angles to one another on the radiator cap and each set at an angle of 45° from the direction in which the car is travelling. Thus a clear view of side roads is given as soon as the car's bonnet reaches the turning. While this device obviously saves only a bare fraction of a second it will prove of considerable value, for it is only too often that an instant marks the margin between danger and security.

* * * *

Post Bag "Bombs"

Those of our readers who live on the direct line of an air route need not alarm themselves if they spot a "bomb" dropping from a passing aeroplane. In a few moments it will resolve itself into a "mail carrying" parachute. This is the anticipated outcome of the work of several inventors who are at present engaged in perfecting devices that will permit air mails to be landed safely from express machines without a reduction in speed. For example, a machine travelling from Belfast to London could drop its mail bags into enclosed spaces, along the line of route, specially reserved for the purpose by the Post Office authorities.

While full technical details are not yet available, it may be stated that each of the inventions likely to mature into the practicable stage is employing a clockwork timing delay system. The rough working plan is as follows. The bag is placed in the ejecting apparatus by a travelling Postal Official at the height of 6,000 ft. As the machine nears the enclosed space into which the bag has to be shot, he will take aim through a sighting apparatus, similar to that used by bombing planes, and at the correct moment the mail bag will be released. For the first few seconds it will drop like a stone but, when within say 30 ft. of the ground, a parachute will open and arrest the fall of the bag, enabling it to alight gently and without damage.

It remains only for some brainy reader of the "M.M." to invent an apparatus enabling the plane to pick up a bag under similar conditions of speed and height, and we can foresee the Royal Mail contracts passing definitely into the hands, or should we say wings, of Royal Mail-planes!

* * * *

For Poultry-Keepers

Those of our readers who include poultry keeping among their hobbies will find the following device an assistance in providing chickens with fresh water. A stake driven into the ground, two iron bands, a large bottle and the drinking pan are all that is required. Fill the bottle and pan with water, invert the bottle with its mouth submerged and fresh water will flow into the pan automatically as required. The iron bands of course are used to attach the bottle to the stake.

"Wireless Made Easy"

HAVE YOU SEEN THE NEW RADIO BUILDING SYSTEM IN WHICH ALL COMPONENTS FIT A STANDARDISED TABLE

BUILDS JUST LIKE MECCANO

CIRCUITS CAN BE ERECTED AND WORKING IN A FEW MINUTES.

COMPLETE INSTRUCTIONS GIVEN.

NO TOOLS REQUIRED.

BUILDING TABLE

PRICE
3/6

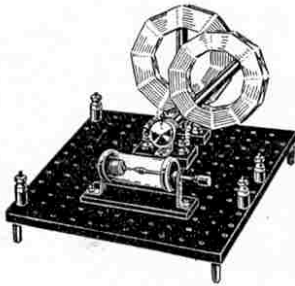

Patent No. 185,180
(A Typical Crystal Set).

WRITE FOR BOOKLET WHICH DESCRIBES THE BLACKADDA WAY AND ILLUSTRATES FULL RANGE OF COMPONENTS AND SETS.

MANUFACTURERS & PATENTEES :

THE BLACKADDA RADIO COY. LTD.

SADLER GATE
DERBY

Telephone :
Derby 1820

Telegrams :
"Blackadda," Derby



"XLLOS" Coils—the latest IGRANIC achievement—possess electrical and mechanical features which are sought after by all discriminating radio experimenters. They are highly selective and give increased signal strength and greater range of reception. "XLLOS" coils are extremely adaptable as regards mounting—a feature which is of special value, since it enables them to be used under the most efficient conditions and in many different types of coil-holders. Two pins are supplied with each "XLLOS" Coil, permitting two pin, two socket, or pin and socket mounting.

Write for the Igranitic leaflet J3, or see the coils at your dealer's.

Exclusive
Manufacturing
Licenses of



PACENT
Radio
Essentials

149, Queen Victoria St.,
London.

Works : Elstow Road,
Bedford.

TRIDE A CAPTAIN **LOWEST EASY TERMS**

You can have the finest cycle built—a "CAPTAIN" sent **PACKED FREE** and **CARRIAGE PAID** on 14 DAYS' **FREE APPROVAL**, for small deposit only. Money refunded if dissatisfied. Lifelong Guarantee. Write for **FREE BARGAIN LISTS** **WRITE NOW**
H. FITZPATRICK
102, Captain Works, Burnley

19 WEEKLY

-Don't Do This!
Don't carry the milestones on your mind. Fit a
VEEDER CYCLOMETER
on your Bicycle and let it register the miles for you.
You can rely on its accuracy.

REGULAR 6/6
TRIP 15/-

Insist upon the name **VEEDER**
OF ALL CYCLE AGENTS.

THE WORLD'S GREATEST CYCLE OFFER

Read the specification of the Graves "Speed King" cycle.
B.S.A. 3-SPEED GEAR
DUNLOP Roadster Cord Tyres
RENOLD CHAIN
MIDDLEMORE'S Three Coil Spring Saddle
The frame is rust proofed, enamelled Black & Coach lined for All Black if desired. Lady's or Gent's Model. Carriage Paid **£6:0:0**
Tens: 8/- with order 8/- monthly.
CATALOGUE POST FREE.
J. G. GRAVES Ltd. Sheffield

8/- NOW

Ten Years Guarantee

No More Punctures

Stop tinkering with tyre levers, messy solutions and patches. Send a P.C. for this booklet which tells how to end puncture mending for ever. It's

Where there's a wheel - here's the way

Free

to Meccano Readers.
Address:
JACKSON'S IMPERVO
(Dept. 31a)
5, Point Hill, Greenwich, S.E.10

BUILD IT YOURSELF

You can Build a **£40 Sideboard Gramophone**, or a **£20 Four-Valve Set** with our Drawings & Fittings for 40/-

Catalogues 2d.

Wireless Components.
Jazz Sets, Gramophones and Records.
R. C. BURT & CO.,
366, York Rd., Wandsworth, S.W.18.

IT WILL PAY YOU

to send for our Illustrated Catalogue which we send free upon receipt of a Card. Every day we are receiving repeat Orders from satisfied customers.
WHY NOT BE ONE!

FRANBERS,
163a, High Street, DERTEND, BIRMINGHAM.

SIXTH SERIES:

Meccano Model-Building Contests

FURTHER SPLENDID PRIZES TO BE WON

The competitions announced below are the sixth pair of a series appearing in these pages each month. Many keen Meccano boys derive great pleasure from thinking things out for themselves, rather than copying from ready-made designs, and these boys should not miss the opportunity to compete for the splendid prizes offered. Every contest is complete in itself and separate prizes will be awarded for the best entries received in each. The models submitted in the competitions must be the competitors' own unaided work, both in design and construction.

In the March issue of the "M.M." we announced the fifth pair of competitions of the series, in which some valuable prizes are offered. These two competitions do not close until the end of the present month.

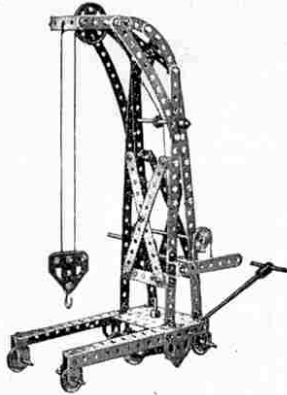

"CRANE" COMPETITION 18 Cash Prizes

Entries in this competition will be divided into the following sections:
SECTION A, for competitors residing in the British Isles;
SECTION B, for competitors residing outside the British Isles.
Competitors' ages will be taken into consideration when judging the entries.
Prizes will be awarded for the best entries FROM EACH SECTION as follows:—
FIRST PRIZE, £3-3s.; SECOND PRIZE, £2-2s.; THIRD PRIZE, £1-1s.; Six prizes of 10/6 each. Other competitors whose entries show outstanding merit will be presented with complimentary copies of "Meccano Standard Mechanisms," while in addition, a few special Certificates of Merit will be awarded, at the judges' discretion, for entries closely approaching prize-winning standard.

Closing date for Section A, 30th June, 1926. Overseas Section, 30th September, 1926.

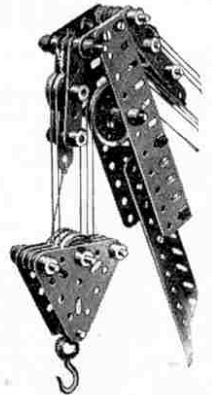

HOW TO ENTER. For this month's competition we have chosen Cranes—a subject that should prove very popular. Cranes have always played an important part in Meccano model-building, owing to the fact, perhaps, that they lend themselves to a wide diversity in design, and may be reproduced with remarkable accuracy even with the smallest outfits.

You may fashion your model from any type of crane that you prefer, or with which you are most familiar. Derricks of all types, gantries and all other kinds of cranes will be accepted under this heading, and they may range in size from the small portable crane to the giant block-setting structures.

When completed, send in a photograph or good drawing of your model, together with any explanations that you think necessary, although the latter should be made as brief as possible.

You may use any Outfit or number of parts. The first prize in each section will be awarded to the competitor who builds the crane

that the judges decide to be the best model entered in that section, and the second and third prizes will be awarded to the second and third best models, and so on. It is wise to remember that very often the simplest and most straight-forward models are better than the most complicated structures.

IMPORTANT. The following instructions should be followed closely. Write your name and address on the back of each photograph or sheet of paper used, and state your age, name of the competition, and section in which your model is entered. Address the envelope: "Crane Competition," Meccano Ltd., Binns Road, Liverpool.

Do not send models. A clear photograph or good drawing is all that is necessary. Photographs or drawings will be returned if desired, providing a stamped-addressed envelope of the necessary size is enclosed with the entry.

"NO. 5 OUTFIT" COMPETITION

In this competition, which is the last of the "Outfit" series, we are offering prizes for the best models made entirely from a No. 5 Meccano Outfit. Models comprising parts that do not appear in this outfit will be disqualified. It is not necessary to use all the parts contained in the outfit.

Those boys who possess larger sets need not abstain from competing, for their entries are eligible providing only those parts which may be found in the No. 5 Outfit are used.

An interesting feature of the contest is the fact that all competitors will be using a similar number and variety of parts.

Entries will be divided into the following sections:—

- SECTION A, for boys under 12 years of age.
- SECTION B, for boys over 12 years of age.
- SECTION C, for boys residing overseas.

Prizes will be awarded for the best entries FROM EACH SECTION as follows:

- FIRST PRIZE: Meccano or Hornby Goods to the value of £2-2s.
- SECOND PRIZE: Meccano or Hornby Goods to the value of £1-1s.
- THIRD PRIZE: Meccano or Hornby Goods to the value of 10/6.

Other competitors whose entries show outstanding merit will be presented with complimentary copies of "Meccano Standard Mechanisms," while, in addition, a few special Certificates of Merit will be awarded at the judges' discretion for models that closely approach prize-winning standard.

Closing dates for Sections A and B: 31st May, 1926. Overseas Section, 31st August, 1926.

IMPORTANT. These instructions should be followed closely. Write your name and address on the back of each photograph or sheet of paper used, and state your age, name of the competition, and section in which your model is entered.

Address envelopes: "No. 5 Outfit Competition," Meccano Ltd., Binns Road, Liverpool. Models should not be sent. A clear photograph or good drawing is all that is necessary. Photographs or drawings will be returned if desired, providing a stamped addressed envelope of the necessary size is enclosed with the entry.



Contents of No. 5 Outfit

16 of No. 1	2 of No. 19	3 of No. 45	6 of No. 90
26 " " 2	4 " " 19A	4 " " 46	3 " " 94
4 " " 2A	2 " " 19B	1 " " 47	2 " " 95
12 " " 3	8 " " 20	2 " " 47A	2 " " 96
8 " " 4	2 " " 21	2 " " 48	1 " " 98
36 " " 5	4 " " 22	10 " " 48A	4 " " 99
4 " " 6	3 " " 22A	6 " " 48B	7 " " 100
6 " " 6A	3 " " 23	4 " " 48D	2 " " 102
14 " " 8	2 " " 24	1 " " 50	2 " " 103F
4 " " 8A	3 " " 26	4 " " 52	2 " " 108
4 " " 9	2 " " 27A	2 " " 52A	1 " " 109
1 " " 9D	1 " " 28	5 " " 53	3 " " 111
12 " " 10	2 " " 29	3 " " 54	2 " " 115
8 " " 11	1 " " 32	1 " " 56	1 " " 116
36 " " 12	2 " " 34	2 " " 57	4 " " 125
4 " " 12A	18 " " 35	13 " " 59	5 " " 126A
2 " " 13	1 " " 36	4 " " 61	1 " " 128
1 " " 13A	1 " " 36A	2 " " 62	2 " " 130
3 " " 14	175 " " 37	6 " " 63	1 " " 134
4 " " 15	24 " " 38	1 " " 65	1 " " 147
5 " " 15A	6 " " 40	1 " " 70	1 " " 148
5 " " 16	2 " " 41	2 " " 77	
5 " " 17	1 " " 43	1 " " 80A	
4 " " 18A	1 " " 44	4 " " 89	



The Secretary's Notes

From reports I have received it is evident that many clubs have already done a great deal towards arranging a programme of outdoor activities for the Spring and Summer months. Some clubs appear to have made no move in this direction

The Outdoor Season

however, and apparently they are waiting until the longer and warmer days actually arrive. Such a policy is extremely unwise and I strongly advise the newer clubs that are approaching their first Spring and Summer sessions to tackle the matter immediately and in earnest. Year after year I have received sorrowful communications from club secretaries bewailing the fact that, owing to delay in arranging their outdoor programme, they have found it impossible to accomplish half as much as they intended. The importance of early preparation is perhaps greatest in the case of clubs that intend to run a cricket team. The old saying, "First come first served," applies with particular force in this connection, and a team that gets to work early is almost certain to get more and better fixtures than one that waits until the cricket season is actually at hand.

It is a comparatively easy matter for a large club to plan out a comprehensive outdoor programme because it has sufficient members to carry out a great variety of schemes. The position is much more difficult, however, for small clubs. There are many clubs whose membership does not permit of the formation of a cricket team or even of a cycling section, and there is a danger that the Leaders of these clubs may come to the conclusion that it is not worth while to try to struggle on through the Summer and that the best plan is to close down until the first Winter session arrives. I admit that in a few cases local circumstances make it practically impossible to carry on throughout the Summer, but as a general rule it is not only possible but profitable to have regular meetings throughout the long days, although perhaps at less frequent intervals than during the Winter. One of the simplest and yet most effective methods of keeping a small club in being is the arrangement of a series of rambles in the neighbourhood. It is important, however, that these

A Hint for Small Clubs

rambles should be carefully planned beforehand, because nothing wearies the average boy so much as an aimless walk from one place to another and back again. A year ago I suggested in these notes that rambles of this kind could be made extremely popular if the Leader gave a little time to the study of the history of the neighbourhood and, after planning a ramble to pass certain points of interest, told the story of this place or

Davenport (Stockport) M.C.

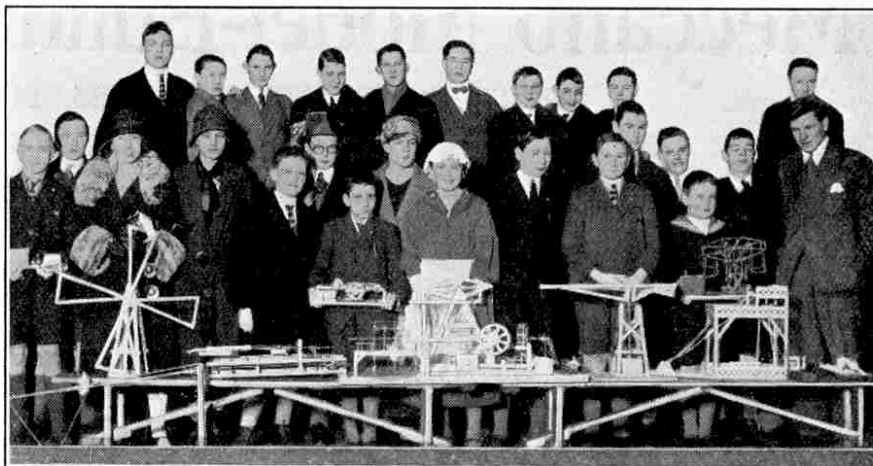

Photo] [H. Clarke, Stockport

Our photograph shows the interesting collection of models brought together by the Davenport (Stockport) Meccano Club at its recent exhibition. This effort met with very gratifying success and afforded ample evidence of the enthusiasm of the members and the enterprise of the Leader, Mr. A. Johnston, and the secretary, A. D. Stoker. The club celebrates its third anniversary on the 18th of this month.

rambles should be carefully planned beforehand, because nothing wearies the average boy so much as an aimless walk from one place to another and back again.

A year ago I suggested in these notes that rambles of this kind could be made extremely popular if the Leader gave a little time to the study of the history of the neighbourhood and, after planning a ramble to pass certain points of interest, told the story of this place or

Walks and Talks

"The Guild Secretary as I Imagine Him to Be!"



Prize-winning sketch by N. Edgar, Blaydon-on-Tyne (It isn't a bit like me, really!—Sec).

that to his members in a chatty manner as they strolled along. An old house, for instance, is simply an old house to the average boy and he will pass it by with scarcely a glance. If that house happens to have been the scene of some interesting or even thrilling event fifty, a hundred or more years ago, the informal telling of the story will rouse keen interest in almost every boy. He looks upon the old building from a fresh standpoint altogether and once his interest is thoroughly aroused it does not readily decline. As an alternative to this kind of talk, many Leaders are able to keep their little company of members thoroughly interested in chats on botany, geology, birds, etc.

A book that will be of interest and value to club Leaders and secretaries has been compiled by Mr. J. W. Haynes of "Fontmell," Covers Road, Claygate, Surrey, Leader of the Claygate Juvenile Club. The book gives a detailed account of the formation of the club in 1919 and its progress up to the present time. From a very modest beginning with meetings of a few boys in Mr. Haynes' home, the club has grown and developed steadily and rapidly. In 1921 a girls' section was incorporated under the guidance of Mrs. Haynes. The Claygate Club is now one of the most successful in the country, its membership numbering well over 70. Copies of this book may be obtained from Mr. Haynes for 7d. post free.

A Club History

Since my announcement of the new Brooch Badge I have received many letters from girl members enquiring whether they could exchange their old badges for the new type. I am quite willing to arrange this, and any girl member who sends me her old badge will receive a brooch badge in exchange, free of charge.

The New Badge

Since my announcement of the new Brooch Badge I have received many letters from girl members enquiring whether they could exchange their old badges for the new type. I am quite willing to arrange this, and any girl member who sends me her old badge will receive a brooch badge in exchange, free of charge.