

MAY 1925.

# MECCANO

## MAGAZINE

PRICE  
**3<sup>D</sup>**  
VOL. X  
Nº 5



SHIPPING LOCOS OVERSEAS (see page 213)





# Happiness for the next five months.

## Be Up-to-Date and Have this British Steam Model Launch

### MISS AMERICA

The hull is 30 ins. long with 3½ ins. beam, finished off in three colours of beautiful enamel which is both heatproof and waterproof. The engine is of oscillating cylinder type, and is well made of brass throughout. It works splendidly and drives the boat at a good speed for over 20 minutes. A patent safety lamp is supplied and a safety valve is fitted to the boiler. The twin bladed propeller is of brass and a tiller allows the boat to be guided in any direction. Altogether a wonderful piece of British value.

PRICE, with lamp, filler and instructions **12'6**  
Postage 9d. extra

OTHER MODELS 22/6 and 30/-

You can call and see the boat in any good class stores or at the Hobbies Branches in London, Glasgow, Manchester, Birmingham, Leeds, Southampton, Brighton and Sheffield. Or you can safely order through the post direct from

**HOBBIES LTD. (Miss America Department), DEREHAM, NORFOLK**

Sailing yachts are out of date—the modern boy must have a power driven model launch. Here's one to suit you—to delight you—to give you lasting pleasure right through the summer. Any boy can run it—and any lake or calm river is just the place for it. Can't you imagine it steaming away to the delight and envy of all your friends.

Never before has such a model been produced at such a price. Only mass production and the sale of thousands make it possible. Already British Boys and Meccano Boys all over the world are having some glorious times with it. Read the full details of it here and get your father to buy you one at once.

FREE LIST OF FULL PARTICULARS TO ANY MECCANO BOY WHO WILL WRITE NOW FOR ONE . . . . .

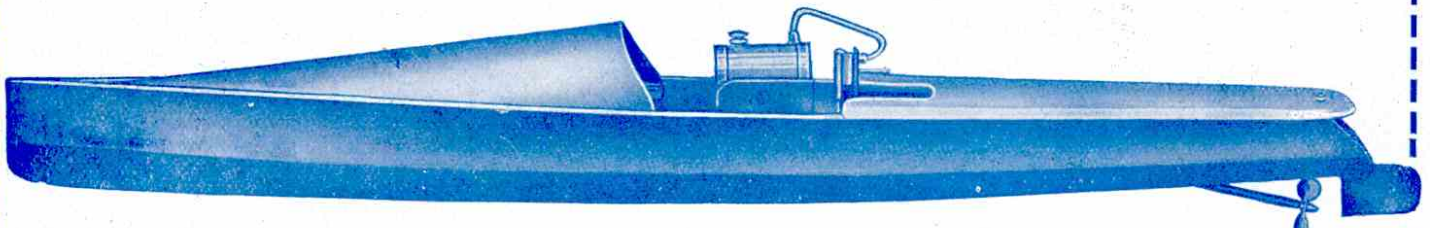

MISS AMERICA—30 inches Long, 3½ inches Beam—THE BRITISH WONDER



EDITORIAL OFFICE

Binns Road,

LIVERPOOL

Vol. X, No. 5.



# MECCANO MAGAZINE

PUBLISHED

IN THE INTERESTS  
OF BOYS

May 1925

## With the Editor

### Our Million Ancestors

During the past few months I have been greatly struck by the number of wonderful discoveries that have recently been made in connection with our ancestors. I am afraid that we do not often think of our ancestors in these busy times. I do not mean our fathers, our grandfathers or even our great-grandfathers, but our ancestors of thousands of years ago, of whom we have a vast number. For instance, we each have a father and mother—that is two. They each also had fathers and mothers, and they—our grandfathers and grandmothers—had fathers and mothers, making altogether fourteen ancestors for us. Taking it only one step further, we find that each of us had sixteen great-grandfathers and grandmothers, so that altogether, to this point only, we have accounted for thirty ancestors in all.

It thus becomes quite easy to understand that our ancestors are very numerous. Indeed, only the other day I read that every person has at least a million ancestors—in other words, it has required a million ancestors to make us what we are to-day! Try to imagine this long line of ancestors behind each of us—a line stretching back through the Middle Ages, far beyond the days when the Romans ruled Britain—back to the time of primitive man, even before the time when the mammoth or hairy elephant, the great woolly rhinoceros and the sabre-toothed tiger roamed at large in the forests that covered Britain.

### Recent Wonderful Discoveries

We know little of the people who lived in those far-off days, but every year new discoveries add to our knowledge. Every year we learn more and more of the hidden secrets of the remote ancestors of mankind and of ancient civilisations that have long since passed away. During the past few months discoveries seem to have been more than usually numerous and interesting.

Recently, for instance, a fossil skull, unearthed at Taungs in South Africa, has created quite a sensation among scientists, for, on account of its very great age, it must have belonged to one of the earliest men. We have heard also of wonderful prehistoric wall-paintings discovered by three boys in Western Europe. More recently the tomb of an ancient ruler in Egypt has been found which dates back to a time as far removed from the days of Tu-tank-amen as the days of "Tut" are from King George V. In the Far East the forgotten capital of a lost empire has been unearthed and a library of 2,500 books in seven languages, including a dictionary of an unknown and mysterious tongue. In another part, ancient silk-lined tombs have been discovered 50 ft. below the earth, containing the bodies of Chinese princes buried thousands of years ago.

### Rock Pictures of Ancient Red-Men

The recent discoveries are not confined to what is generally called the "Old World." In the west more than one expedition is now exploring Central America, where last year wonderful discoveries were made of relics of ancient nations that flourished thousands of years ago. Pyramids and rock carvings resembling those of ancient Egypt were found, along with the ruins of great cities, with huge palaces, temples, and other buildings. The explorers had to hack their way through a dense jungle and all the ruins are buried in an undergrowth so dense that it completely covers them and renders them invisible.

In Nevada, strange rock pictures have been revealed. These are believed to be the work of Red Indians who lived thousands of years ago, and it is claimed that the carvings are of an age more ancient than those of Egypt. Many of these ancient rock pictures are found on the rocks of the "Hill of a Thousand Tombs," which forms part of the burial ground of an extinct race. It is believed that the rock pictures are the work of these people or their ancestors.

### East and West

Probably you will wonder what possible connections there could be between Red Indian rock carvings of thousands of years ago and you and me to-day. Yet there is a connection—although it certainly is very remote—and the several ways by which we know this is one of the most wonderful stories of science. To deal with these at length would be out of place here, but perhaps one instance may be mentioned, more especially as it is directly connected with the rock carvings already described.

With the exception of one, none of the signs can be interpreted, and so their message remains hidden. The single exception has been explained to scientists by the Chief of the Piute Indians, who said that this particular sign was used by his tribe as a charm to keep away the devil. One day recently the carvings were seen by an educated Chinese, who is a student at the University of Nevada. A sign at the entrance of the valley in which the rock pictures occur first attracted his attention, and after carefully examining it he declared it to be identical with the sign used in China to-day to charm away the devil!

He examined more of the rock pictures and found many other signs that corresponded with Chinese characters in an ancient dictionary that he was able to obtain. With this dictionary, which contains characters in use before the time of the Chin dynasty, more than 3,000 years ago, he was able to identify seven of the "world pictures" and translate them with certainty. The characters he translated mean:—a thousand, sky, earth, wooded vale or valley, mountain, centre, and wolf.

### A Common Ancestry

The Chinese student believes that the secret of the rock pictures can be discovered in time, but it will be a slow and laborious undertaking, for his dictionary contains over 50,000 Chinese characters! This is very interesting and we shall all look forward to the time when the meaning of the rock pictures is revealed to us.

In the meantime, however, the story has a great and wider interest. The fact that an illiterate Red Indian and a highly educated Chinese student, neither of whom had ever heard of the other, within a few weeks each interpreted a thousands-of-year-old sign to have an identical meaning, shows a direct connection between the Chinese and the Red Indians.

Similarly it is believed that connections exist between all the races of the earth. In many cases the connections are comparatively easily traceable, in others they are more difficult and remote. Gradually we are coming to believe that if we could look far back, to long before the time of the mammoth and sabre-toothed tiger, we should find that all nations came from one common ancestry who had their home in Asia—perhaps India—and who spread from there to all parts of the Earth.



# Lives of Famous Engineers

XVI  
Isambard K. Brunel  
and the  
GREAT WESTERN  
RAILWAY

THE success of the Liverpool and Manchester Railway, which was opened for traffic in 1825, drew general attention to the superiority of the railway over road and canal. In 1825 the merchants of Bristol had attempted to form a railway company, but without success, and for the time being the idea was abandoned. In 1832, however, another attempt was made, and a committee was set up to work out a scheme for a railway from Bristol to London.

The committee's first task was to select an engineer to carry out the preliminary survey and prepare an estimate of the cost of the project, and Brunel was among the candidates for the post. He was well known in Bristol as the engineer of the Clifton Suspension Bridge, and although many of the other candidates had strong claims, he obtained a majority of votes and was appointed engineer in March 1833.

### House of Lords Reject the Bill

Brunel spent the next three months in making his survey, and in July a meeting was held at which the scheme was brought before the public. A month later a company was formally constituted and the Parliamentary survey begun. By the end of November it became evident that subscriptions were not coming in as fast as had been hoped, and the directors realised that they would not be in a position to lodge a railway Bill for the whole line. It was determined, therefore, to apply for Parliamentary powers to construct a railway from London to Reading and from Bath to Bristol, leaving the completion of the scheme for a later date.

The Bill was introduced into the House of Commons early in 1834 and after passing the second reading it was referred to a Committee. The investigation occupied 57 days, during which period every possible kind of opposition was brought forward. Brunel's cross-examination lasted no less than 11 days, during which the clearness of his evidence and his ability and knowledge made a great impression. George Stephenson was one of the witnesses and in his evidence he said: "I can imagine a better line, but I do not know of one so good." The Bill successfully passed this stage, but was defeated in the House of Lords and therefore thrown out.

This setback did not discourage the promoters, however, and they lost no time in preparing to bring in another Bill in the following year. By this time sufficient money had been raised to enable the whole line, from London to Bristol, to be constructed.

### Bill Receives the Royal Assent

This Bill also met with strong opposition and some very curious objections were brought against it. It was said that the Thames would be choked up for want of traffic, that the drainage of the country

would be destroyed and that Windsor Castle would be left unsupplied with water. It was argued that Eton College would be utterly ruined because the most abandoned inhabitants of London would come from town by the railway and pollute the minds of the boys, and the latter would take advantage of their play hours and run up to town, mix in all the dissipation of London life and return before their absence could be discovered! In spite of all this opposition, however, the Bill succeeded and the Royal Assent was given on 31st August, 1835.

### Opening of the G.W. Railway

The Great Western Railway was constructed with very few deviations from the line sanctioned in this Bill. The most important alteration was carried out at the London end where, by an Act passed in 1836, the line was taken to Paddington instead of joining the London and Birmingham railway near Kensal Green. This change of route was brought about by a difference that arose between the two companies in regard to the terms of their agreement.

The railway was opened to Maidenhead, a distance of nearly 23 miles, in June 1838 and to Twyford, eight miles further, a year later. The line from Twyford to Reading was opened in March 1840 and from Reading to Chippenham in May 1841. In the meantime the section of line from Bristol to Bath had been opened in August 1840, and by 30th June 1841 the last section from Chippenham to Bath was opened and the railway was thus completed throughout its whole length.

Brunel

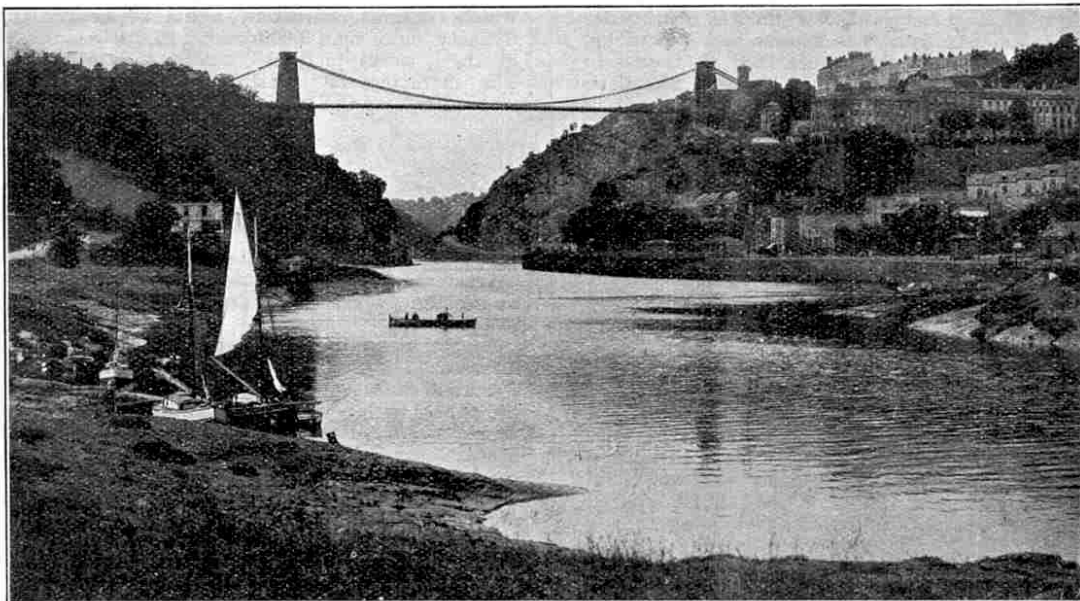
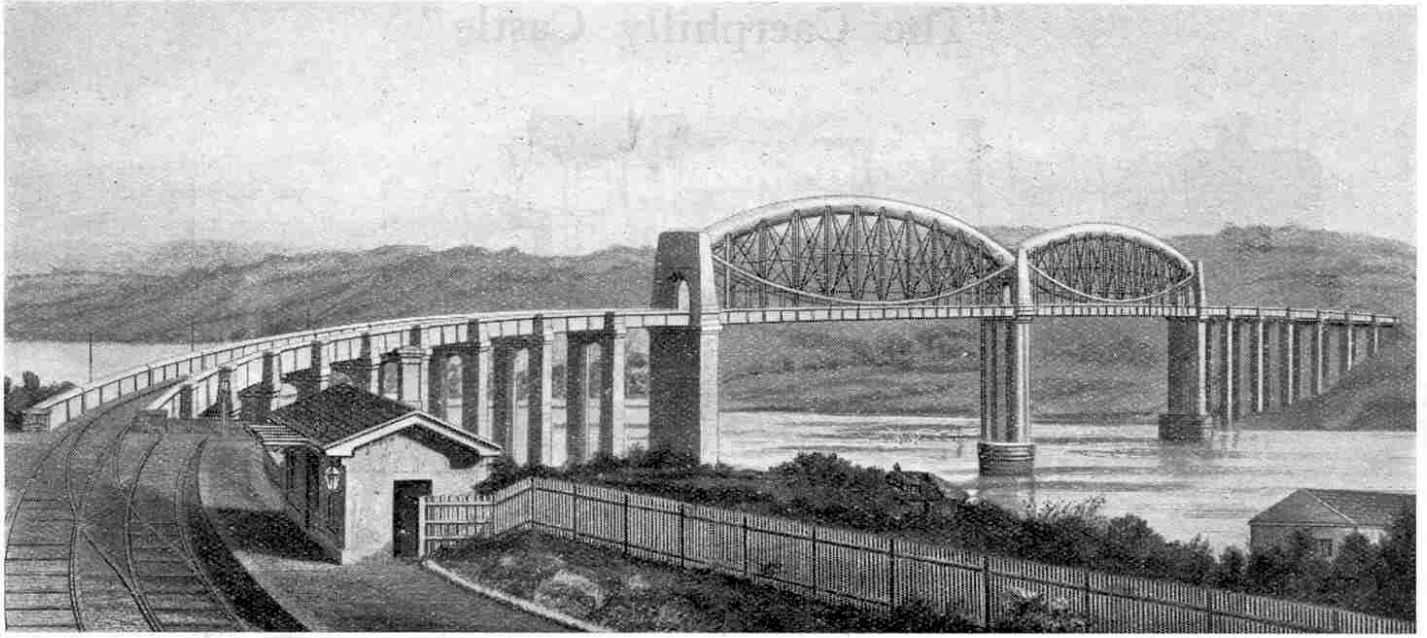

Photo courtesy]

Clifton Suspension Bridge, designed by Brunel and completed after his death

[G.W. Railway





Saltash Bridge in Brunel's day

subsequently constructed numerous important subsidiary lines connected with the Great Western main line and also acted as engineer to railways in Ireland, Italy and elsewhere. Our space does not permit of a description of these lines and we must now turn our attention to the historic "Battle of the Gauges."

The early railways were little more than adaptations of the old wooden tramways which, in their turn, were developed from the ordinary road carts. In consequence the gauge or distance between the rails of the first railways was based upon the distance between the wheels of the carts employed in the northern counties of England. When George Stephenson came to lay down the track for the Stockton and Darlington line he saw no reason to change this gauge—4 ft. 8½ in.—and later the same gauge was adopted for the Liverpool and Manchester railway, the Grand Junction railway and the London and Birmingham railway. In this manner the gauge of 4 ft. 8½ in., subsequently known as the "narrow gauge," became established.

#### Brunel decides on a 7 ft. Gauge

In the first Bill for the Great Western Railway the gauge was mentioned as being 4 ft. 8½ in., but in the second and successful Bill Brunel secured the omission of any mention of the gauge at all, thus leaving the question open for future consideration.

Brunel was convinced that there were many advantages to be gained by an increase in the gauge and he finally decided that the Great Western gauge should be 7 ft., and proceeded to lay the track accordingly. He thought that the wider gauge, with the corresponding greater width of base of the coaches, would give increased steadiness and smoothness of running and also greater safety, particularly at high speeds. He also hoped by adopting this gauge to keep the west and south-west of England exclusively for the Great Western Railway.

On this matter George Stephenson took a longer and wiser view. At one

time it was proposed to adopt a special gauge for the Leicester and Swannington Railway, but Stephenson replied: "I tell you the Stockton and Darlington, the Liverpool and Manchester, the Canterbury and Whitstable and the Leicester and Swannington must all be 4 ft. 8½ in. Make them all the same width; though they may be a long way apart now, depend upon it they will be joined together some day."

#### Committee's Tribute to Brunel

In 1845 the gauge question was referred to a Royal Commission. The Commissioners sat from August to December, during which time they examined 48 witnesses, 38 of whom directly advocated the narrow gauge, eight favoured gauges of from 5 ft. to 6 ft., and the remainder, including Brunel, championed the broad gauge. Early in 1846 the Commissioners reported that the gauges were equal in regard to the safety and comfort of the passengers; that the broad gauge had the advantage in point of speed; that the narrow gauge was more convenient for goods traffic; that the broad gauge involved a larger outlay and that, as far as they could see, there were not sufficient compensating advantages to set against this greater first cost. They therefore recommended that 4 ft. 8½ in. should be declared to be the gauge to be used on all public railways built in Great Britain.

In face of this decision it is interesting to note that in one part of their report the Commissioners said: "We feel it a duty to observe that the public are mainly indebted for the present rate of speed and the increased accommodation of railway carriages to the genius of Mr. Brunel and the liberality of the Great Western Railway Company."

As the result of the report of the Commissioners an Act for the regulation of the gauge of railways was passed, rendering it unlawful to construct new lines in Great Britain of other than 4 ft. 8½ in. gauge without first securing special Parliamentary sanction. From that time the standardisation of the narrow gauge

became inevitable.

On a considerable portion of the broad gauge track a third rail was laid down in order that the line might be used by vehicles of either gauge. Then began the conversion of the broad gauge to the narrow gauge, a process that occupied 24 years. The final conversion took place on 21st and 22nd May, 1892, and it provided a remarkable example of perfect organisation.

#### Changing to Narrow Gauge

Preparations for the change had been taking place for years previously in the building of narrow gauge locomotives and coaches and placing them temporarily on wheels with widened axles so that they could run on the broad gauge track as long as might be necessary. When the time for the final conversion drew near, these hybrids were converted to true narrow gauge vehicles in a very ingenious manner, which was well described in the souvenir number of the Great Western Railway Magazine issued in June 1913. The writer of the article said:—

"In two of the roads of the repairing shop four drop pits were provided in each of which was a table fitted with trollies, which could be lifted and lowered by hydraulic pressure. A subway gave access from one pit to another. To change the bogies, the carriage was shunted on to the table on the first road until the bogies rested on the trollies, and the tables were then raised so as to bodily lift the carriage, which was then dropped. The various connections having been disconnected, the tables were lowered, taking with them from each end of the carriage the bogies, which were transferred by means of the trollies to the tables in the opposite pits and lifted to rail level by hydraulic power, thus being free to run out of the shop, leaving a second set of tables to take a new set of narrow gauge bogies. The tables bearing the latter were then lowered and the bogies transferred to the tables of the first pit, where they were lifted above rail level in order to re-make the connections between the frame of the coach.

## "The Caerphilly Castle"

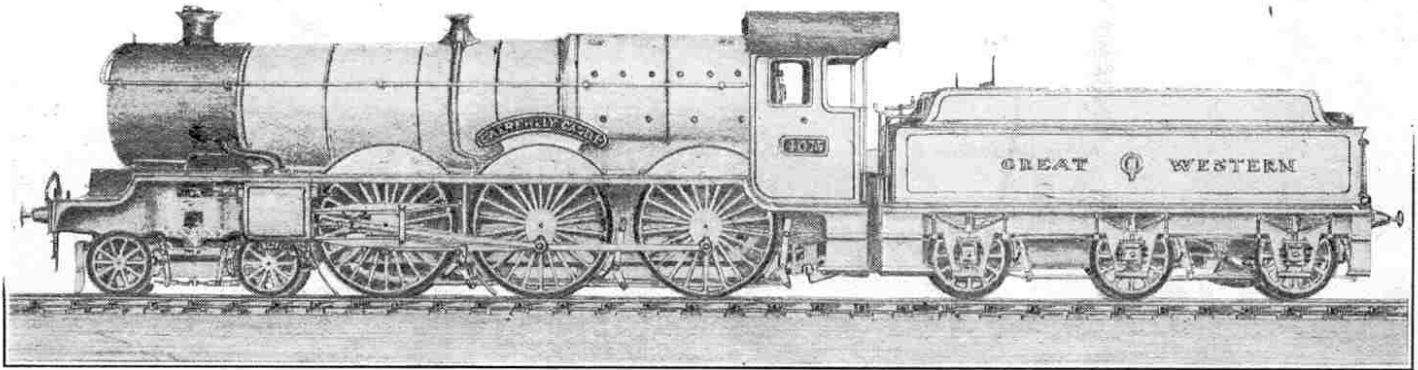

G.W. Loco. No. 4073 (4-6-0)

Drawn by R. W. Tippett, Acocks Green, Birmingham (Age 16), and awarded First Prize (tie) Class A in our Second Drawing Competition.

When this was completed the coach was shunted out. In this manner as many as 20 coaches were completed in a single day."

The result of all this careful preparation was that narrow gauge locomotives and coaches were available for service immediately the gauge change was completed. The whole conversion, including the alteration or scrapping of the old stock, is estimated to have cost the company nearly £800,000.

The final conversion of the G.W.R. brought to a close one of the most remarkable engineering controversies in railway history.

### Brunel's Ambition

Although Brunel was thus beaten in the "Battle of the Gauges," his ambitious broad gauge scheme proved of great value in speeding up railway development in general. The position is well summarised in the following extract from Samuel Smiles's book on the two Stephensons:—

"Mr. Brunel, however, determined that the Great Western should be a giant's road, and that travelling should be conducted upon it at double speed. His ambition was to make the best road that imagination could devise; whereas the main object of the Stephensons, both father and son, was to make a road that would pay. Although, tried by the Stephenson test, Brunel's magnificent road was a failure so far as the shareholders in the Great Western Company were concerned, the stimulus which his ambitious designs gave to mechanical invention at the time proved a general good. The narrow-gauge engineers exerted themselves to quicken their locomotives to the utmost; they were improved and re-improved; their machinery was simplified and perfected; outside cylinders gave place to inside; the steadier and more rapid and effective action of the engine was secured; and in a few years the highest speed on the narrow-gauge lines went up from thirty to about fifty miles an hour.

"For this rapidity of progress we are in no small degree indebted to the stimulus imparted to the narrow-gauge engineers by Mr. Brunel. And it is well for a country that it should possess men such as he, ready to dare the untried, and to

venture boldly into new paths. Individuals may suffer from the cost of the experiments, but the nation, which is an aggregate of individuals, gains, and so does the world at large."

### The Saltash Bridge

In the course of his railway work Brunel built a large number of bridges and viaducts, using at different times brickwork and masonry, timber, cast iron and wrought iron. Many of these works have been demolished and replaced by modern structures, and of those that still remain the finest is the Royal Albert Bridge that carries the railway over the river Tamar at Saltash. At this point the river is 1,100 ft. in width with a depth in the middle of about 70 ft. at high water.

It was first proposed to construct the bridge with one span of 255 ft. and six of 105 ft., with superstructures of timber-

trussed arches. In order to comply with the requirements of the Admiralty the design was altered to two spans of 300 ft. and two of 200 ft., with a clear headway of 100 ft. This plan would have required three piers in deep water, but Brunel subsequently decided to have only one pier in deep water and to have two spans of 465 ft.

As finally constructed the Saltash Bridge consists of two main spans of 455 ft. with 17 smaller spans of about 69 ft. 3 in. each, making a total length of bridge of 2,240 ft. The single arched rib of each large span is built up of wrought iron plates forming a hollow tube, oval in shape and about 17 ft. in width and 12 ft. in depth. In addition there are two suspension chains each consisting of two tiers of links, each tier being formed of 14 and 15 links alternately. The links are 7 in. in depth and about 1 in. in thickness. The ribs and chains are so braced together as to form what is in effect a bowed trussed girder from which the bridge deck is hung. The depth from the top of the arched tubes to the bottom of the longitudinal girders is 56 ft.

The main trusses of the bridge were floated into position on pontoons and then lifted, in a similar manner to the tubes of Robert Stephenson's Britannia and Conway bridges. When Stephenson was ready to undertake the floating of these tubes he asked Brunel for assistance. Brunel took an active share in most of the subsequent proceedings, particularly in regard to the Conway bridge, and the knowledge he then gained was of great use to him in the erection of his Saltash bridge. At Saltash there was not the same difficulty with regard to swiftness of the tide as there had been at the Britannia floatings.

The Saltash Bridge was opened by the Prince Consort on 3rd May, 1859. Unfortunately Brunel was not able to be present as he was in poor health and was away on the Continent at the time. The total cost of the bridge was £225,000.



Photo by]

[John Stark

### "The Kobenhavn"

A five-masted auxiliary barque, the largest sailing ship in the world and built at Leith

**NEXT MONTH:—**

**Brunel and the "Great Eastern"**

# Shipping Locos. Overseas

## British Engines for Queensland, India and Belgium

ON account of their unsurpassed excellence, the products of the British engineering firms have long been in demand in all parts of the world. Overseas orders have included cranes, turbo-generators, hydraulic and electrical equipment, all kinds of engines, lathes, and other forms of similar machinery and even extend to locomotives and rolling stock. In fact, the export of locomotives is becoming so considerable and frequent that a special ship has been built for the sole purpose of shipping locomotives overseas.

### Shipping Locos. in the Clipper days

Locomotives have been exported from this country for many years. Records show that locomotives were being shipped to Queensland as early as 1872 in the days when the Clipper ships were at the height of their fame. Of course, the handling of such bulky cargoes in those days was a very different matter from what it is to-day. There were, for instance, no giant cranes to sling the locos. on board. Instead, the shippers were lucky if they had at their command such primitive devices as shear legs and steam cranes. Even these comparatively crude appliances were rare and only to be found at the busiest ports in this country. The larger ports in our colonies had no such facilities.

The shipping of locomotives on one particular vessel, the "City of Agra," has been described for us in detail.\* The "City of Agra" (1,074 tons) was built at Sunderland in 1860 and was one of the first iron clippers to be engaged in the Australian wool trade. Early in 1872 she arrived in London with wool from Melbourne, and having unloaded her cargo she was fitted out for the accommodation of emigrants, who were flocking in vast numbers to Queensland as a result of the discovery of gold in that colony.

\*By Mr. C. F. Smith in his "Book of Famous Ships."

### Landing Locos. with Capstan and Tow Rope

On this voyage, which was completed without incident, she also took across three locomotives, each weighing 25 tons and built for the 3 ft. 6 in. gauge railways of Queensland.

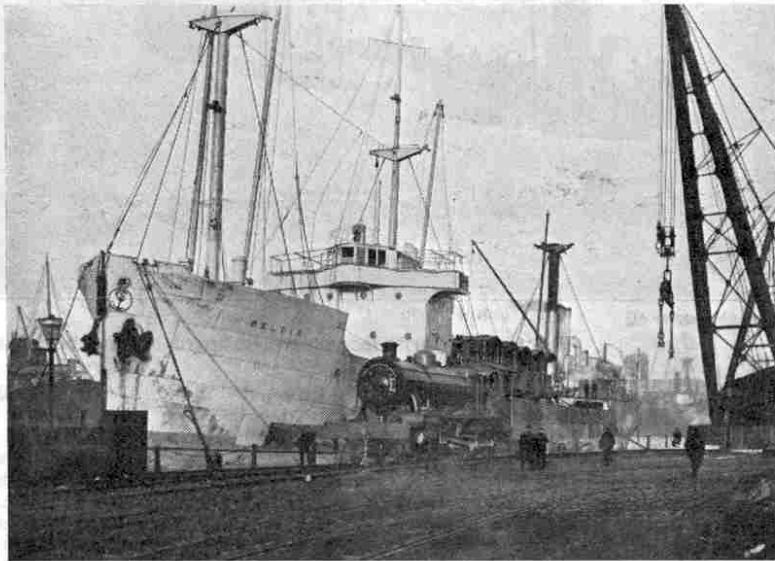

Photograph courtesy of]

[Messrs. The Vulcan Foundry Ltd.

The special locomotive-carrying ship "Beldis" lying at the West Float, Birkenhead, with the 70-ton crane "Hercules" on the right.

The loco. in the foreground is about to be shipped and four more locos. are seen in position on the deck of the vessel aft.

board or on shore—in fact there was not even a steel hawser! The available gear consisted only of a couple of coils of 5-inch Manila rope, four 30-inch four-fold blocks, two single blocks of the same size, and four 18-inch three-fold blocks, and a number of single blocks also 18-inch.

"The tow line was passed round the fore and main topmast heads," says Mr. Smith, "a preventer forestay and cap backstay being rigged at the main. The main yard was untrussed and lashed securely to the mast, a double purchase to the main-topmast head acting as a preventer lift. A spar was then lashed two-thirds out on the main yard. One big block was lashed to the tow rope above the main hatch, and another at the junction of the spare spar and the main yard, and the tackles rove. The engines were hove up by the capstan windlass; and a rare lot of shantying must have been required to get them up and into lighters!"

(Continued overleaf)

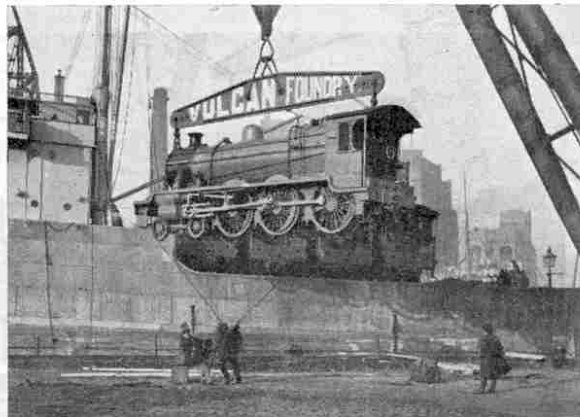

Photograph courtesy of]

[Messrs. The Vulcan Foundry Ltd.

A loco. being lifted on board



### Locos. for India

It is difficult to describe the great changes in equipment and practice that have taken place since these early locomotives were shipped to Queensland on the "City of Agra." To-day the handling of large numbers of locos. for shipment overseas is a matter of comparative ease. Already this year a large batch of 4-6-0 locomotives with eight-wheeled tenders have been made by the Vulcan Foundry Limited, of Newton-le-Willows, Lancs., and shipped to the East Indian Railway Company.

These locos. were consigned on the motor ship "Beldis," which left Birkenhead on Christmas Day last, bound for Calcutta, with thirteen assembled locos. stowed on her deck. Four other locos. and the tenders for the whole seventeen were stowed below. The locos. were part of an order of the East Indian Railway Company for forty similar locos. Two additional locos. are being built for the Madras and Southern Mahratta Railway, and two more for the Nizam's State Railway. These latter four are of the same design as those of the larger order, except that they have slight modifications to suit the requirements of the respective railways for which they are intended.

### Details of the Locos. for India

All the locomotives are of the 4-6-0 type and are fitted with underhung springs, the last pair being compensated. The driving wheels are 6 ft. 2 in. in diameter at the tread, the centre diameter being 5 ft. 8 in. The bogie wheels are 3 ft. in diameter. The total wheelbase of the engine is 27 ft. 3 in. and of the engine and tender 56 ft. The brakes are of the automatic vacuum type and operate on the wheels of both engine and tender. In addition there is a hand-brake fitted on the tender.

The cylinders are placed outside the frames and have a diameter of 20½ in. × 26 in. stroke. They are equipped with piston valves on top, actuated by Walschaerts valve gear and of the trunk type with inside admission.

The boilers, 15 ft. 6 in. in length and 4 ft. 9½ in. inside diameter, have a working pressure of 180 lbs. per square inch and are fitted with four safety valves of 3½ in. diameter. The elements of the Marine and Locomotive pattern superheaters are joined to the header with ball and socket attachment.

The fireboxes, which are made of copper, are 7 ft. 5½ in. in length, 4 ft. 5½ in. in width, 6 ft. 6 in. in depth at the front and 4 ft. 9½ in. in depth at the back. All fireboxes are equipped with steam-operated rocking motion and drop grate.

The grate area measures 32 sq. ft.,

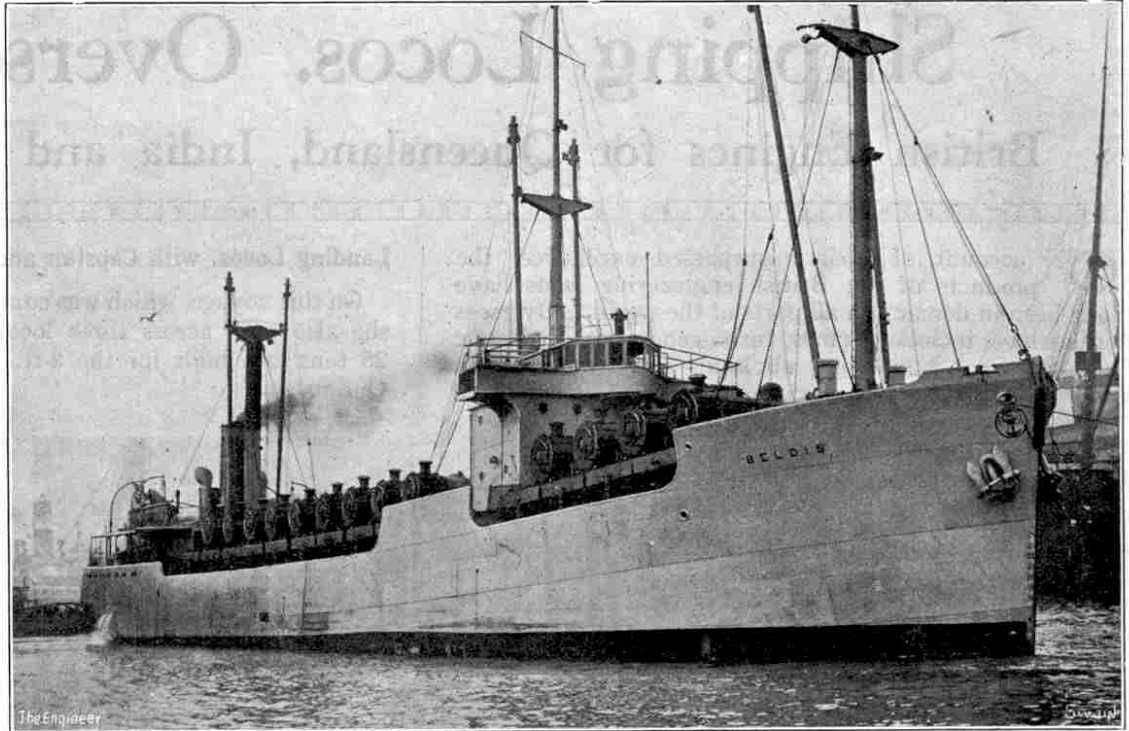

Photograph courtesy of]

["The Engineer."]

### The "Beldis" with locomotives on board, leaving the dockside

there being ninety-one tubes of 2¼ in. diameter and twenty-two smoke-tubes of 5¼ in. diameter with a length between tube plates of 15 ft. 10¼ in.

The total heating surfaces is 832 sq. ft. made up as follows: Firebox, 152 sq. ft. Tubes, 850 sq. ft. Smoke-tubes, 478 sq. ft. Super heater, 352 sq. ft.

The tenders are of the eight-wheel bogie type with wheels of 3 ft. 7 in. diameter. The capacity of the tender is 4,500 gallons of water, and 10 tons of coal. The total weight of the engine is 73 tons, 52½ tons being distributed on the driving wheels and 20½ tons on the bogies. The tender weighs 61½ tons laden, so that the total weight of the engine and tender in working condition is just over 134 tons.

### The Specially-Designed Motor-Ship

The motor ship "Beldis" was specially built for S. A. S. Christen Smith's Rederi, of Oslo, Norway, by Messrs. Sir W. G. Armstrong Whitworth & Co. Ltd., at

their Walker shipyard on the Tyne. She made her maiden voyage from the Tyne to South America in July last, carrying a large consignment of oil-burning locomotives intended for the Buenos Aires Great Southern Railway.

The vessel has a total dead weight carrying capacity of 3,440 tons, which includes stores, fuel, water, and spare gear. Her draft is 18 ft. 8½ in., overall length 303 ft., breadth 45 ft. and depth 21 ft. 6 in. She has a single deck with poop, bridge, and fore-castle, and is constructed on the transverse system of framing, with upright stem, elliptical stern, and deep bulwarks. She is fitted with a flat plate keel, and bilge keels run for about half her length amidships. Oil fuel and water ballast are carried in the double bottom, and other water ballast tanks are provided in the space between the upper and the bridge decks, and in the large forward and aft peaks.

Living accommodation for the Captain is arranged in a steel house on the bridge and on the upper deck, the chart-room and wireless cabin being situated on the flying bridge. The officers and engineers are accommodated abreast of the engine-casing in the fore-end of the poop. The seamen and other members of the crew find accommodation at the after end of the upper deck.

There are two cargo holds, each served by a large hatchway, and specially arranged to be clear of obstruction. Six 3-ton derricks, each operated by a steam winch, are so arranged that the cargo is discharged with a minimum delay. A complete outfit of stockless anchors, cables, steel wire, and manila hawsers is also carried and the mooring arrangements are well designed for expeditious cargo working.

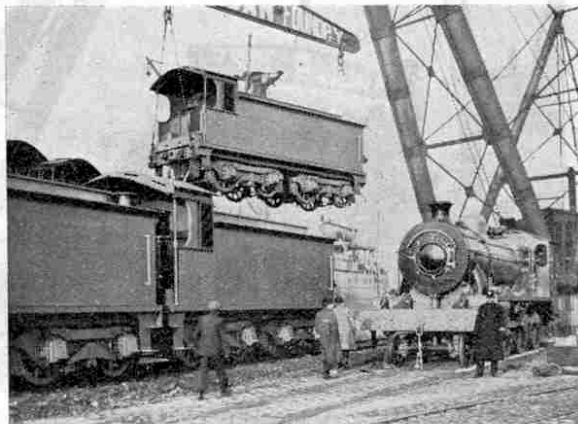
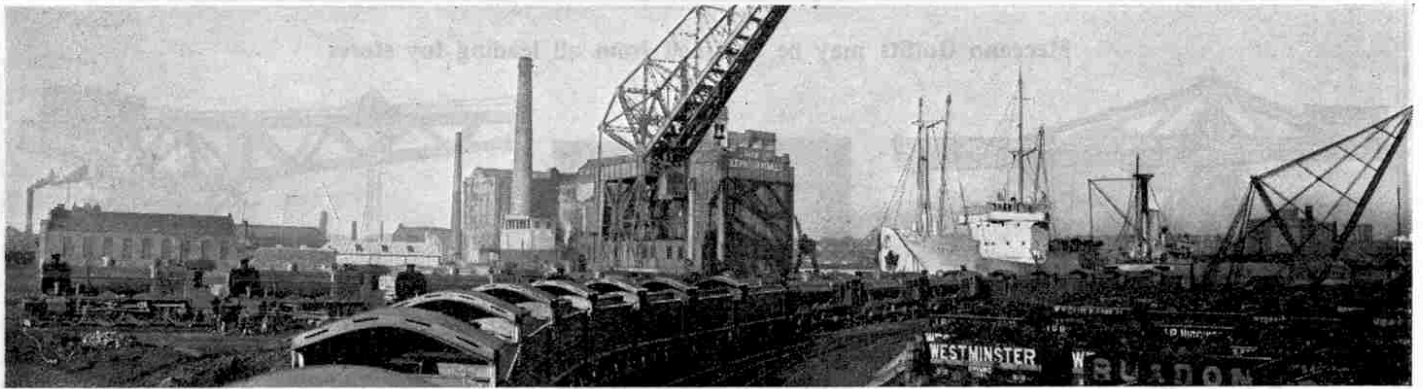

Photo courtesy of]

[Messrs. The Vulcan Foundry Ltd.

### The "Hercules" lifting a tender





Photograph courtesy of]

Some of the engines and tenders on the West Float Dock at Birkenhead

[Messrs. The Vulcan Foundry Ltd.

The motor ship "Beldis," which conveyed them to Calcutta, is seen in the background. In the centre is seen the Floating Crane "Mammoth" which was the subject of our cover illustration in March. It was not, however, engaged in loading these locomotives.

### Propelling Mechanism Details

The "Beldis" is propelled by a single-screw Armstrong-Sulzer Diesel engine of the inverted four-cylinder type, situated aft and capable of developing 1,350 h.p. continuously. It is direct-acting and works on the two-cycle principle with port scavenging, the latter being effected through ports arranged circumferentially in the cylinders opposite the exhaust ports.

The upper row of ports is controlled by means of multiple-ring valves so arranged that they open after the pressure of the exhaust gases in the cylinders has reached its lowest point. They do not close until after the piston, on its upward stroke, has entirely covered the exhaust ports, whereby it is possible to deliver a surplus charge of fresh air into the cylinders.

The engine is fitted with a double-acting air pump and there is a three-stage air compressor, driven by cranks and connecting rods from an extension on the main shaft. A complete electric generator and lighting plant supplies the ship with current.

### Making Light Work of 70-ton Locos.

The loading of the seventeen engines and tenders on to the "Beldis," which was undertaken at the West Float Dock at Birkenhead, was carried out without a hitch by the Mersey Docks and Harbour Board, whose 87-ton steam crane "Hercules" was employed in the work.

The locomotives and tenders were brought in parts from the Vulcan Foundry at Newton-le-Willows to the Birkenhead docks. Here they were assembled on the quay of the Gilbrook basin on a special track, the rails of which were of the same gauge as those of the Indian Railways for which the locos. were intended. After the locos. were assembled they were lifted on board by the 87-ton crane, as shown in our illustrations.

As we have already mentioned, each locomotive weighed about 70 tons but the "Hercules"—as befitted a crane so appropriately named—made light of this and the locomotives were shipped with ease. The "Beldis" had an uneventful voyage and the locos. were

safely landed at Calcutta and all are now working on the Indian Railway.

### 200 Locos. for Belgium

On page 239 there is a short description of the splendid hydraulic crane illustrated on our cover this month. The crane is shown shipping 2-8-0 locos., part of an order for 200 locos. that are being built for the Belgian State Railways by Messrs. Sir W. G. Armstrong-Whitworth Ltd., at Newcastle-on-Tyne.

These Belgian locos. are of very powerful design and are fitted with either the Marine and Locomotive Superheater or the Robinson pattern superheater.

Each loco. is fitted with two cylinders, 24 in. in diameter and 28 in. stroke. The boiler pressure is 200 lbs. per square inch, at 85% of which the tractive force works out at 45,820 lbs. The boiler barrel is composed of three rings, 5 ft. 6½ in. in diameter outside the largest ring, and is 14 ft. 9½ in. in length; the length between the tube plates being 14 ft. 9 in.

The fireboxes are of the Belpaire type, the inner boxes of copper being 10 ft. 6 in. in length and 3 ft. 3½ in. in width at the bottom. They are designed for burning briquettes, and fitted with a special grate, which has only very small air spaces. The back head of the boiler slopes forward and the grate is also sloped considerably.

### Belgian Loco. Details

The locos. are designed to pass over curves of 120 metres radius. At the front end of each is a pony truck, centred at the back of the cylinder box stay. The truck and two front pairs of driving wheels are equalised in the usual manner.

The coupling rod pins for the trailing wheels are spherical and at the trailing end the rear axle 30 m.m. (1.2 in.) side play is given in the boxes to either side. The axle loading is moderate, the heaviest load—on the main drivers—being 18 tons 17 cwt.

The following table, giving the principle dimensions, will no doubt be of interest:—

### Locomotive

CYLINDERS: two; diameter 24 in.; stroke 28 in. WHEELS: diameter 4 ft. 11.84 in.; wheelbase 28 ft. 1½ in.; wheelbase fixed 12 ft. 1 in. BOILER: diameter 5 ft. 6½ in.; length of barrel 14 ft. 9½ in. FIREBOX: length 10 ft. 6 in.; width 3 ft. 3½ in. TUBES, BOILER: number 174; diameter 1.969 in. SMOKE: number 28; diameter 5.236 in.; length 14 ft. 11½ in. HEATING SURFACE: boiler tubes 1,323.9 sq. ft.; smoke tubes 565.2 sq. ft.; firebox 202.5 sq. ft.; total 2,091.6 sq. ft. SUPERHEATING SURFACE: 479 sq. ft. WORKING PRESSURE: 200 lb. sq. in. GRATE AREA: 35.1 sq. ft. LENGTH (frame): 38 ft. 2 in. WEIGHT in working order: 80 tons 4 cwt.

### Tender

CAPACITY—COAL: 6 tons 17 cwt. WATER: 23 tons 12 cwt. WEIGHT: 52 tons 16 cwt. TOTAL WEIGHT: Engine and tender, in working order, 133 tons.

It is interesting to note that the potential output of Messrs. Armstrong Whitworth's Scotswood Works is 450 main line locomotives per annum, or practically 1½ per day. These locomotives are in use on British, Colonial, and Foreign railways all over the world, and the fact that they are giving satisfactory service is evidenced by the numerous repeat orders that the firm constantly receive.

### A Royal Saloon

From so important a port

(Continued on page 239)

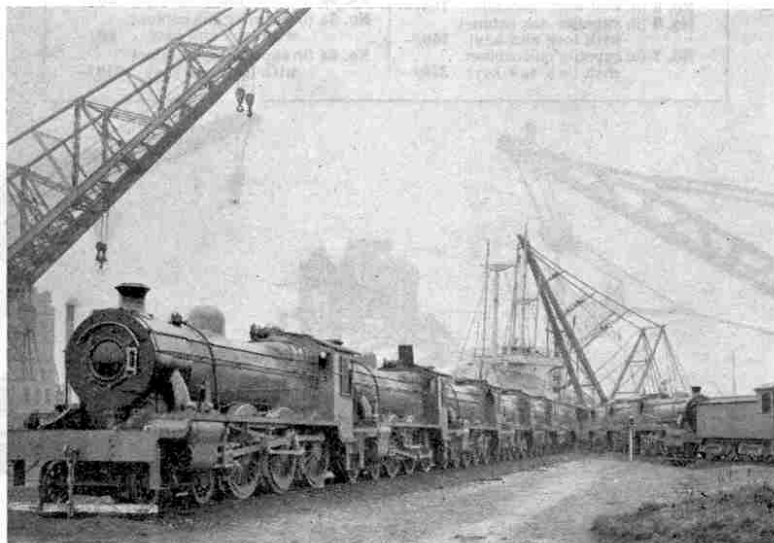

Photograph courtesy of]

[The Mersey Docks & Harbour Board

Some of the locos. waiting to be shipped  
The crane "Hercules" and ship "Beldis" on the right, the "Mammoth" on the left.

Meccano Outfits may be obtained from all leading toy stores

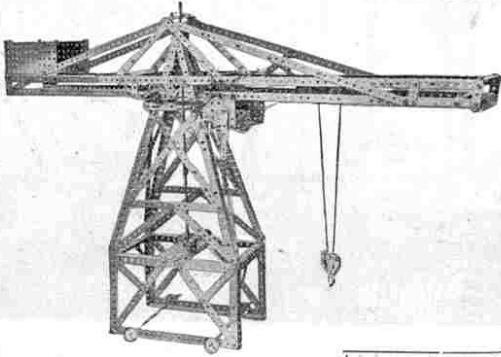

Radial Crane

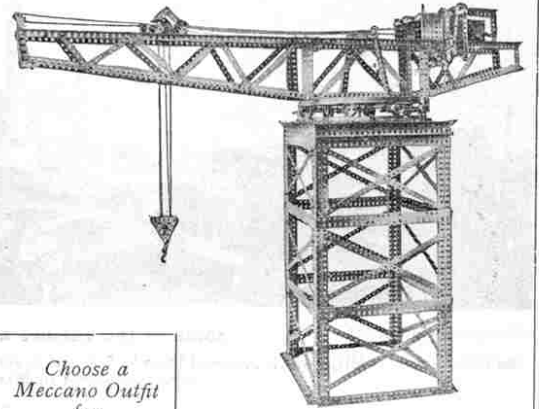

Hammer-Head Crane



*This No. 2 Outfit costs 15/- and builds 163 Models.*

*Choose a Meccano Outfit for Your Next Present*

# MECCANO

ENGINEERING FOR BOYS

You can build hundreds of working models with Meccano: Cranes of all types, Big Wheels, Motor Chassis, Lathes, Clocks, Looms that weave real fabric, and hundreds of others all equally interesting. No study is needed, you can commence building immediately you open your Outfit. The big illustrated Book of Instructions that goes with each Outfit makes everything easy.

Meccano is sold in nine Outfits of varying sizes, numbered 00 to 7, and each Outfit may be converted into the one higher by adding the next Accessory Outfit. Thus if a No. 2 Outfit is bought it may be converted into a No. 3 by purchasing a 2a; a No. 3a would then convert it into a No. 4, and so on up to No. 7.

COMPLETE OUTFITS		ACCESSORY OUTFITS	
No. 00 ... ..	3/6	No. 00a ... ..	1/6
No. 0 ... ..	5/-	No. 0a ... ..	4/-
No. 1 ... ..	8/6	No. 1a ... ..	7/6
No. 2 ... ..	15/-	No. 2a ... ..	8/6
No. 3 ... ..	22/6	No. 3a ... ..	18/6
No. 4 ... ..	40/-	No. 4a ... ..	15/-
No. 5 (in well-made carton) ...	55/-	No. 5a (in well-made carton)	50/-
No. 5 (in superior oak cabinet with lock and key)	85/-	No. 5a (in superior oak cabinet with lock and key)	80/-
No. 6 (in well-made carton) ...	105/-	No. 6a (in superior oak cabinet with lock and key)	210/-
No. 6 (in superior oak cabinet with lock and key)	140/-		
No. 7 (in superior oak cabinet with lock and key)	370/-		

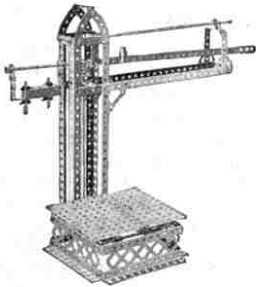

Platform Scales

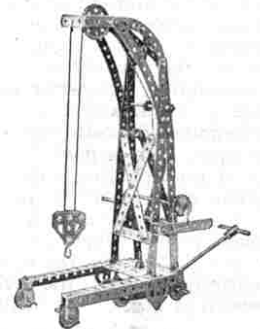

Platform Crane

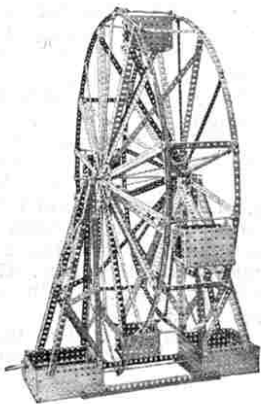

Big Wheel

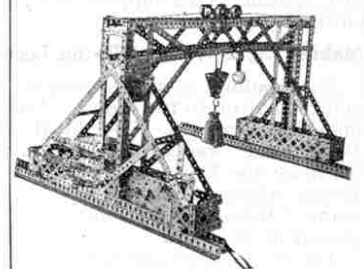

Gantry Crane

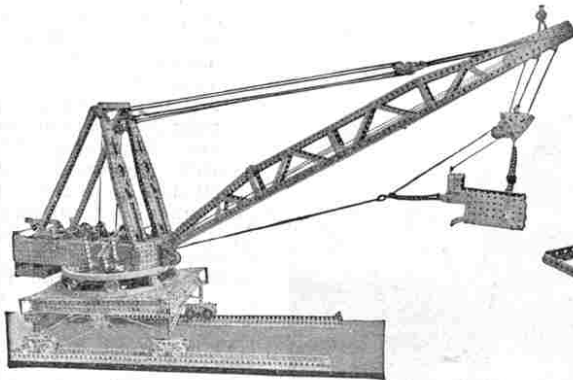

Dragline

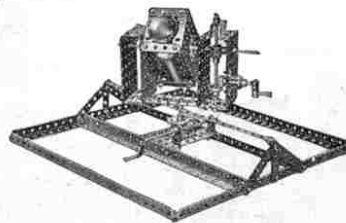

Searchlight

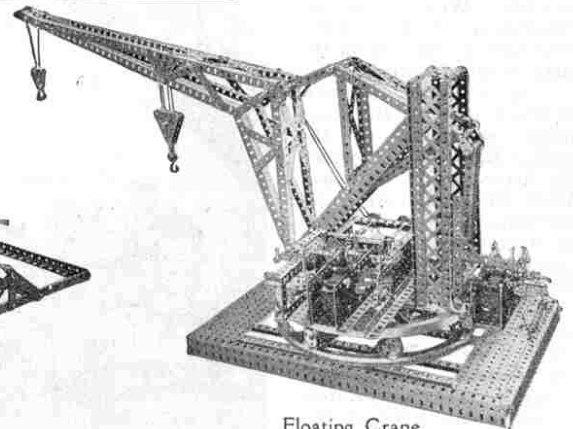

Floating Crane

MECCANO LTD.

BINNS ROAD

LIVERPOOL



# A NEW MECCANO MODEL

## Model No. 623. Platform Weighing Machine

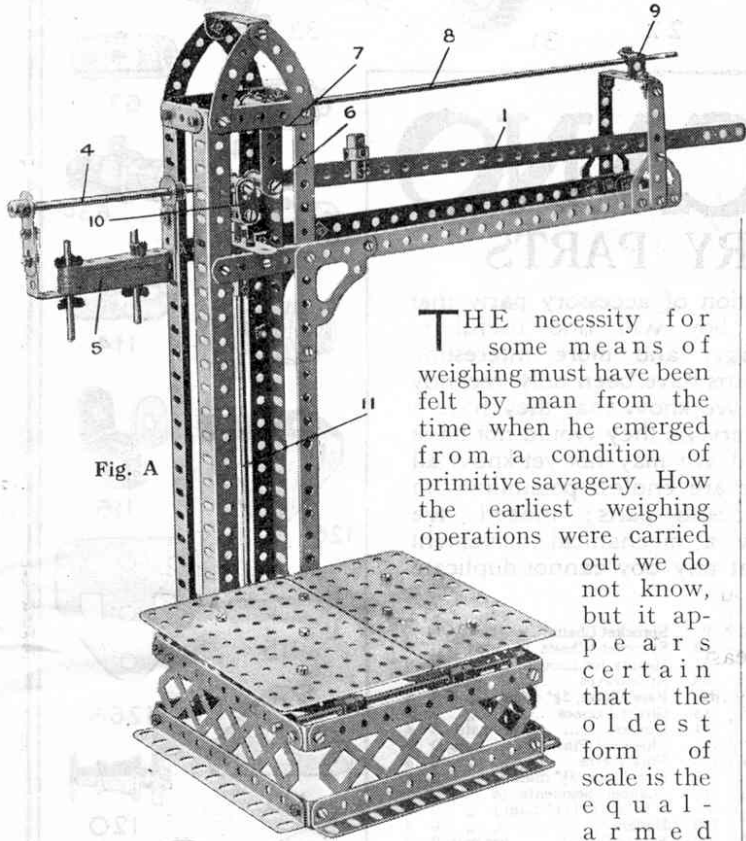

THE necessity for some means of weighing must have been felt by man from the time when he emerged from a condition of primitive savagery. How the earliest weighing operations were carried out we do not know, but it appears certain that the oldest form of scale is the equal-armed balance.

From drawings still in existence it is clear that this form of balance was used by the ancient Egyptians, and no doubt the balance referred to frequently in the Bible was of the same type.

### Importance of the "Knife-Edge"

The ordinary balance consists of a lever of the first order called the beam, supported at its centre on a fulcrum. At each end of the beam is hung a scale pan, one of these pans being for the weights and the other for the object that is to be weighed.

It is necessary that the beam should be able to swing quite freely on its support and in order to ensure this, the fulcrum consists of a steel or agate prism or "knife-edge," with its sharp edge at right angles to the direction of the beam and resting upon a plane of polished steel or agate. This construction reduces friction to the minimum. A pointer fixed to the centre of the beam indicates—by coming to rest in the line of direction from the fulcrum to the centre of gravity of the beam, or by swinging evenly on each side of that line—when the balance is horizontal, which occurs when the weights in one scale pan exactly balance the object in the other.

### The Roman Balance

A very important modification of the equal-armed balance is the steelyard or Roman balance. This

consists essentially of a bar of steel suspended near one of its ends from which hangs the object to be weighed. A weight used as a counterpoise moves along the longer arm of the bar. The result of placing the counterpoise on the longer arm is to enable a small weight to balance a very heavy object, thus doing away with the necessity for using heavy weights.

A simple model of a Roman Balance may be constructed with an O Outfit, as shown in Fig. E. For the construction of this little model the following parts are required:

1 No. 2	2 No. 10	3 No. 22	1 No. 44
1 No. 5	1 No. 17	3 No. 37	1 No. 57

### Roman Balance in its Modern Form

From the simple steelyard has developed the modern commercial platform weighing machine, which is so familiar an object in the warehouses of our industrial towns.

In this type of balance the object to be weighed is not hung directly from the steelyard, but rests upon a low platform. This arrangement enables heavy and bulky objects, such as sacks full of various materials, to be weighed quickly and with the greatest ease. The whole machine is mounted on wheels and thus can be moved about a warehouse as required.

A typical high-class platform weighing machine is shown in the accompanying photograph. Such machines are made in various sizes having capacities of from 3 cwt. to 20 cwt. For weighing certain kinds of material the back rail of the platform shown in the photograph is apt to be inconvenient, and therefore machines may be obtained without this rail.

The same type of machine is used in railway stations, and in other places, without the wheels. Sometimes the machine is mounted in position on a low platform but generally the weighing platform is sunk until level with the station platform. It is generally used in the parcel offices,

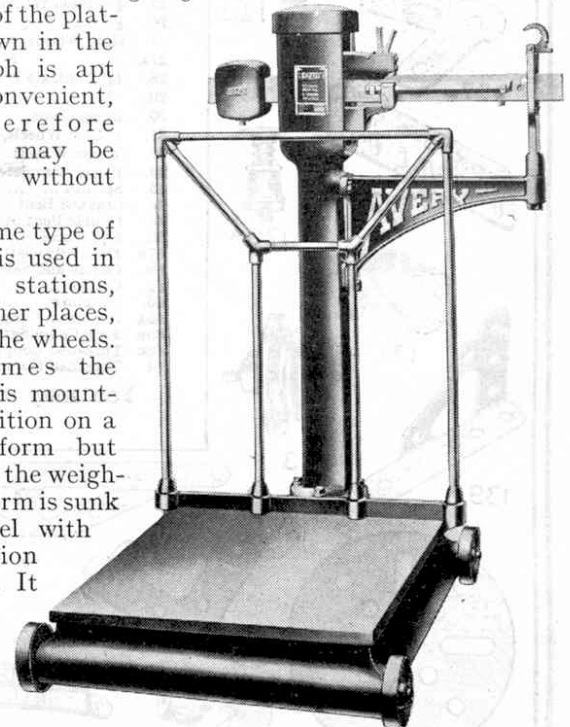
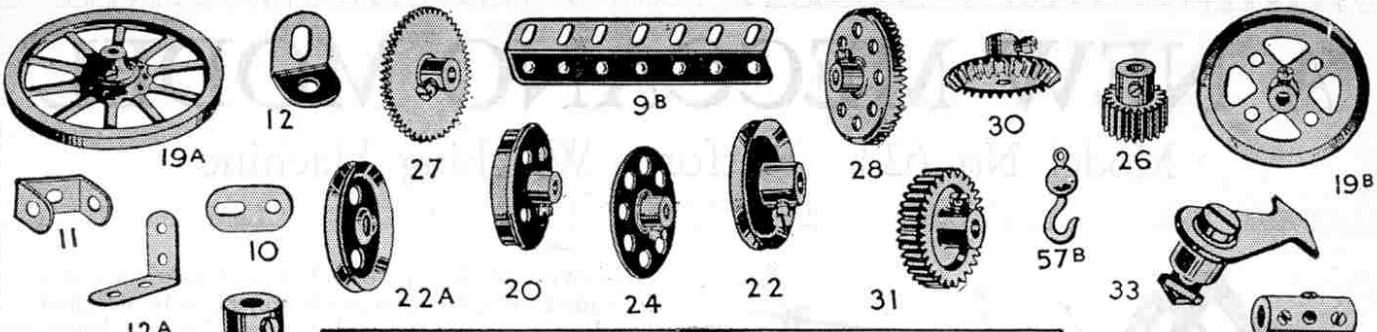

Photo courtesy]

[Messrs. W. & T. Avery Ltd

Portable Platform Weigher

(Cont. on page 219).



# MECCANO

## ACCESSORY PARTS

WE illustrate a selection of accessory parts that every Meccano boy will find useful in building the larger and more interesting models. Many of these parts have been only recently introduced, and although we know that they have a universal use (were it otherwise they would not have been added to the system) we may not yet know all their applications. There are endless possibilities in the employment of Meccano parts; indeed, we wonder if there is now a mechanical movement known to engineering that any boy cannot duplicate with Meccano.

		s.	d.		s.	d.
10.	Flat Brackets ...	doz.	0 2	94.	Sprocket Chain	per length 0 6
11.	Double Brackets ...	each	0 1	96.	Sprocket Wheels, 1"	each 0 3
12A.	Angle Brackets, 1" x 1"	"	0 1	101.	Heads, for Looms ...	doz. 0 9
19A.	Wheels, 3", with set screw	"	0 8	108.	Architraves ...	each 0 2
20.	Flanged Wheels ...	"	0 6	109.	Face Plates, 2 1/2" diam.	" 0 4
	Pulley Wheels:			113.	Girder Frames ...	" 0 2
19B.	3" dia., with set screw	each	0 8	114.	Hinges ...	per pair 0 4
22.	1" " "	"	0 4	115.	Threaded Pins ...	each 0 2
22A.	1" " without set screw	"	0 2	116.	Fork Pieces ...	" 0 3
24.	Bush Wheels ...	"	0 6	118.	Hub Discs (5 1/4" diam.)	" 1 3
25.	2" Pinion Wheels ...	"	0 6	119.	Channel Segments (8 to circle, 1 1/2" diam.)	" 0 4
26.	1" " "	"	0 4	120.	Buffers ...	" 0 2
27.	Gear Wheels, 50 teeth...	"	0 9	120A.	Spring Buffers ...	per pair 0 8
27A.	" 57	"	0 9	123.	Cone Pulleys ...	each 1 3
28.	1 1/2" Contrate Wheels ...	"	0 9	124.	Revsd. Angle Brackets, 1"	doz. 0 10
29.	2" " "	"	0 6	125.	Revsd. Angle Brackets, 1 1/2"	" 6
30.	Bevel Gears ...	"	0 10	126.	Trunnions ...	each 0 3
31.	1" Gear Wheels, 38 teeth	"	1 0	126A.	Flat Trunnions ...	" 0 2
32.	Worm Wheels ...	"	0 6	127.	Simple Bell Cranks ...	" 0 3
33.	Pawls (complete) ...	"	0 4	128.	Boss Bell Cranks ...	" 0 4
43.	Springs ...	"	0 2	129.	Rack Segments, 3" diam.	" 0 6
44.	Cranked Bent Strips ...	"	0 1	130.	Triple Throw Eccentrics ...	1 3
45.	Double Bent Strips ...	"	0 1	131.	Dredger Buckets ...	0 2
50.	Eye Pieces ...	"	0 2	132.	Flywheels, 2 1/2" diam....	" 2 3
57B.	Hooks (loaded) ...	"	0 5	133.	Corner Brackets... ..	" 0 3
59.	Collars and Set Screws	"	0 2	136.	Handrail Supports ...	" 0 3
62.	Cranks ...	"	0 3	137.	Wheel Flanges ...	" 0 4
63.	Couplings ...	"	0 6	138.	Ship's Funnels ...	" 0 4
63A.	Octagonal Couplings ...	"	0 8	139.	Flanged Brackets, Right	" 0 2
63B.	Strip Couplings ...	each	0 8	139A.	Left	" 0 2
63C.	Threaded Couplings ...	"	0 6	140.	Universal Couplings ...	" 0 9
64.	Threaded Bosses ...	"	0 2	144.	Dog Clutch ...	" 1 6

You may obtain Meccano Parts from your Dealer

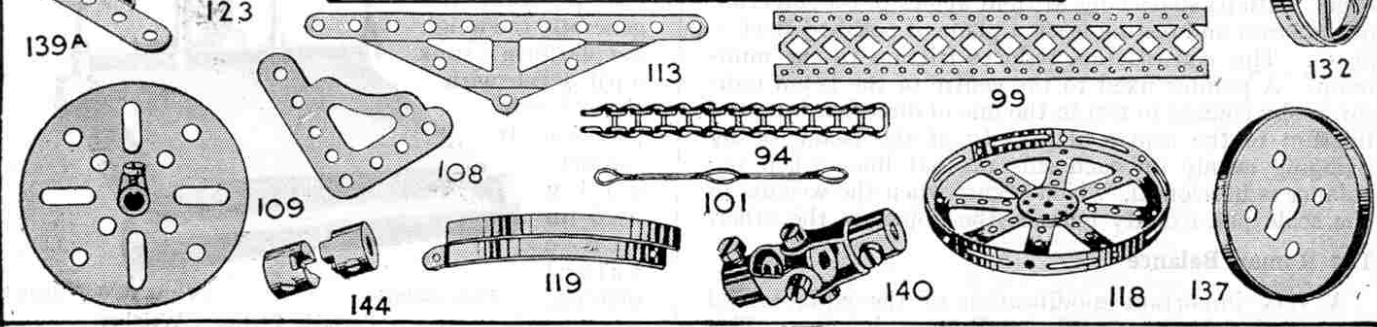
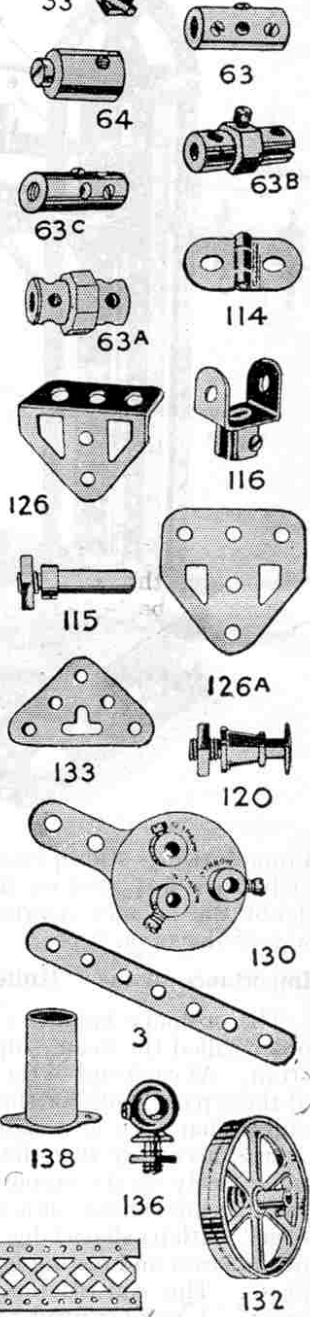



and machines of larger but similar type are employed in the goods yards and in the yards of mills and factories also.

**The Meccano Model**

The construction of the three principal sections of this model—namely, the main upright column, which supports the steelyard and balance lever, the base, and the weighing-platform—may be followed by referring to the general view of the model and Figs. C and D. The last two illustrations detail the base and weighing-platform respectively:

The steelyard (1 Fig. A), consisting of a 12½" Strip, is bolted to two Couplings, one at either end at the rear, as shown at (2 Fig. B), by means of bolts passing through the Strip and entering the threaded borings of the Couplings. Washers placed on the bolts between the Strip (1) and the Couplings ensure that the former is held firmly in position.

A 6" Rod (4) also enters the Coupling (2 Fig. B.) and carries the balance weight (5) made of 2½" Strips carried in a Double-angle Strip secured between two Cranks. The fulcrum (6), through which the Rod (4) passes, consists of a Coupling suspended from two 2" Strips (7) carried from another Coupling at the end of the 11½" Rod (8). The latter is journalled through the centre hole of a 1½" Strip secured to the top of the frame, and its outer end must be engaged beneath the Reversed Angle-Bracket (9) when weighing.

A Coupling (20), secured to the Rod (4) is loosely connected by means of Flat Brackets (10) to a further Coupling mounted on a vertical member (11) which consists of a 1½" Rod and an 8" Rod coupled together.

**Constructing the Platform**

This vertical Rod (11) carries at its lower end a 2" Rod (21), a Coupling secured to which carries two further 2" Rods journalled through the end holes of the Strips (13). The latter in turn are pivotly mounted on a 6" Rod (14) carried in the base of the model. Two 2½" Strips (15), connected in a similar manner to a further 6" Rod (16) and held in place by Collars and Spring Clips, carry a 5" Rod (17) resting upon the Strips (13).

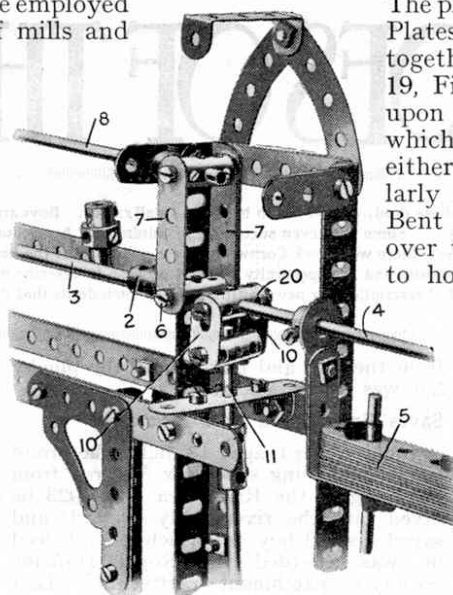

Fig. B

The platform is composed of two 5½" x 3½" Flat Plates, overlapped one hole and secured together by 4½" Angle Girders (18 and 19, Fig. D). The angle Girder (18) rests upon the Strips (15), while the Girder (19), which is mounted upon two Washers at either end to ensure proper contact, similarly engages the Strips (13). Two Single Bent Strips (20) bolted to the plates fit over the centre rod (17), so forming guides to hold the plates in position. The platform is suspended in order to weigh when the Rod (8) is passed beneath the Bracket (19).

**Graduating the Scales**

In constructing the model care should be taken that the weight (5) is sufficient to exactly balance the lever (1) when the adjusting piece—a Strip Coupling sliding along the Strip (1)—is placed against the Coupling (2 Fig. B) at the fulcrum end of the steelyard.

If a weight is placed on the platform, the outer end of the steelyard will rise, and its horizontal position can only be regained by sliding the Strip Coupling away from the fulcrum through a distance proportional to the load being weighed. A piece of plain cardboard may be attached to the steelyard, and on this points should be marked at which the Strip Coupling must be placed in order to balance certain weights. The various positions required for this purpose may be readily ascertained in the first place by experimenting with weights of two or four ounces, or other known amounts.

The efficiency of the scales is improved by carefully oiling all the moveable parts.

**Prizes for Suggestions**

In actual use a little difficulty may be found in weighing very small amounts, such as an ounce or half an ounce, owing to the amount of friction existing in the model. We have ourselves improved the model in this respect, since the accompanying photographs were taken. This provides an excellent test of ingenuity and resourcefulness, and in order to encourage our readers to solve the problem of reducing the friction to the absolute minimum, we have decided to award a prize of one guinea and a second prize of half a guinea for the two best suggestions received. Models should not be sent in, but photographs or sketches. Entries must be sent in before 30th June (Overseas : 30th September).

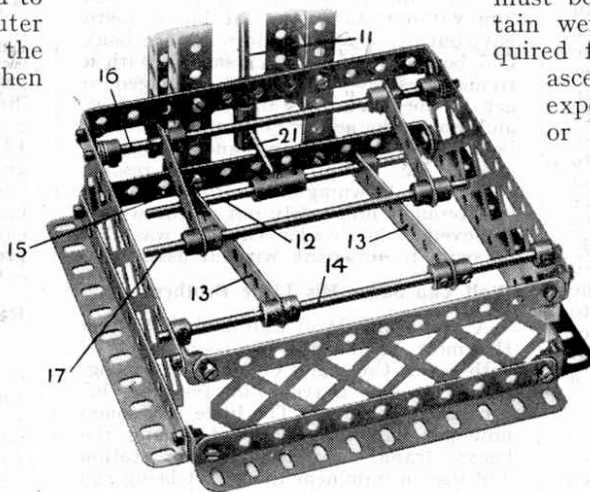

Fig. C

completing photographs were taken. This provides an excellent test of ingenuity and resourcefulness, and in order to encourage our readers to solve the problem of reducing the friction to the absolute minimum, we have decided to award a prize of one guinea and a second prize

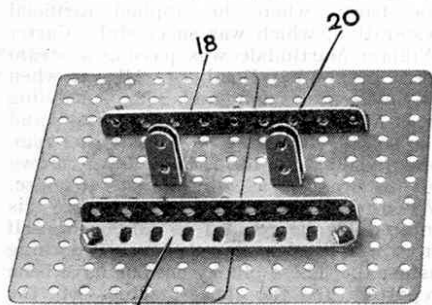

Fig. D

Parts required :					
3 No.	1	2 No.	13	4 No.	48D
2 "	2A	1 "	13A	18 "	59
2 "	4	3 "	14	2 "	62
21 "	5	1 "	15	9 "	63
2 "	6	3 "	17	2 "	63B
4 "	6A	3 "	18A	2 "	70
4 "	8	6 "	35	4 "	90
3 "	9	74 "	37	3 "	100
2 "	9A	10 "	38	2 "	102
2 "	10	1 "	47A	2 "	108
6 "	12	3 "	48	1 "	125
		2 No.	126A		

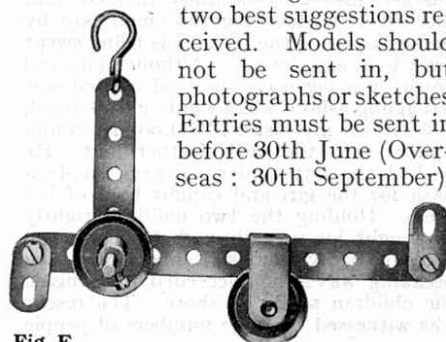

Fig. E

# BOY HEROES OF THE MONTH

In every community there are boy heroes whose deeds are unknown beyond a small radius. Boys are but men in the early stages and their personal courage does not lose anything by comparison with that of men. Some boys even succeeded in joining the Army during the war by all manner of daring expedients and acquitted themselves like men in France and elsewhere—there were Jack Cornwallis in every branch of the Service.

In time of peace there is no dearth of boy heroism and as opportunity allows I propose to describe on this page any brave deeds that come to my notice. I shall be pleased to receive from readers of the "M.M." descriptions or news cuttings of any such deeds that they consider will be of general interest.—*The Editor.*

## Burglar Arrested Through Boy's Presence of Mind

The pluck and presence of mind of a London schoolboy recently led to the arrest of a burglar. The boy, who lives with his parents, Mr. and Mrs. Ring, at West Norwood, was awakened early one Sunday morning by a light in his bedroom. He saw that the light came from an electric torch carried by a man who was moving stealthily towards the dressing table. The boy did not call out, but lay perfectly still and pretended to be asleep, meanwhile watching closely the man's movements. After examining the dressing table and apparently concluding that there was nothing there worth further search, the burglar left the room, locking the door after him. The boy immediately jumped out of bed, threw on a few clothes and a pair of shoes, got out through the window and descended to the ground—some 20 ft. below—by means of the fall pipe. He then scrambled over two garden walls to reach a neighbour's house from where a telephone message was sent to the police station. Without waiting for the police to turn up the boy set off to find a policeman for himself, and soon succeeded in doing so. The constable accompanied him back to the house and saw the burglar in one of the rooms searching a desk. Other policemen soon arrived in response to the telephone call, and the house was quickly surrounded. The burglar caught sight of the policemen in the garden, ran to the top of the house and made his way on to the roof through a trap-door. The police followed, and in a short time the burglar was discovered crouching down behind a chimney stack and was arrested.

## Children Saved from the Sea

A 16-year-old Deal boy named Walter Spicer, the son of a boatman, saved two children, aged 6 and 8 respectively, from drowning in the sea, into which they had fallen. Spicer was walking along the shore one day when he heard screams and caught sight of a boy's head in the water. There was a strong wind blowing at the time and a heavy sea was running. Spicer did not hesitate an instant, but plunged into the sea, fully dressed, and succeeded in clutching the small boy by the neck just as the latter was being swept away by the backwash. Although knocked down by a big wave, he held on and was struggling ashore when the boy exclaimed, "Where is my sister?" Looking round Spicer saw the girl further out. He tucked the boy under his arm, made a dash for the girl and caught hold of her dress. Holding the two children tightly he fought his way through the surf, and though badly knocked about by the breaking waves he succeeded in bringing the children safely to shore. The rescue was witnessed by large numbers of people

from the pier and parade and the plucky lad was loudly cheered.

## Saves Six Children from River Lea

John Orchard, aged 13, holds the proud record of having saved six children from drowning in the River Lea. In 1923 he dived into the river, fully dressed, and saved a small boy, for which gallant deed he was awarded the Royal Humane Society's parchment certificate. Last year he plunged in to rescue a child but found that the child was entangled in something on the river bed. He made another attempt and succeeded in fastening drags to the child's clothing. The little one was quickly brought to the river bank, but sad to say it was too late, and life was extinct. For this brave effort the Royal Humane Society awarded their vellum certificate. A more recent exploit nearly proved disastrous to this brave boy. He dived in after a small boy and reached him without difficulty, but his strength gave out in the struggle to reach the bank and both he and the boy sank. With a tremendous effort Orchard managed to get to the surface again with the boy, and shouted for help. Fortunately another boy was close at hand and heard the shout. He promptly went to the rescue, took the drowning boy from Orchard and brought him safely out of the water. Relieved of his burden Orchard was able to swim to the bank without assistance.

## Wolf Cub Saves His Little Brother

A Weybridge Wolf Cub named William Hickmott, aged eight, has been presented with a Gilt Cross and Certificate in recognition of his bravery in rescuing his brother aged three. The little boy somehow got out into the road among the heavy traffic near the railway station and was in imminent danger of being run over by an approaching taxi-cab. William saw the danger from the footpath, rushed out into the road and pushed his little brother clear of the vehicle. He failed to get clear himself, however, and received considerable injuries to his face and one leg.

## Heroic Attempt Fails

On a recent afternoon two boys went bathing in a reservoir near Wellington, Salop. One of them, Frederick Wainwright, aged 18, who was a very poor swimmer, unfortunately tried to get across the reservoir. On reaching deep water he got into difficulties and his friend, Isaac Bradburn, aged 15, went to his rescue. Wainwright clutched him round the neck and both disappeared. Twice Bradburn released Wainwright's hold by diving and attempted to get him to the bank, but this was beyond his powers, and eventually he himself had to be rescued as he was utterly exhausted. At the

inquest on Wainwright the coroner highly commended Bradburn upon his heroic conduct.

## Courage and Endurance in Gale

During a severe gale on the west coast of Scotland, a large motor boat got into difficulties. The boat was tossed about for many hours and the crew had given up all hope of reaching land. The captain's son displayed great courage and endurance in this terrible position. He climbed up the rigging and held a lighted torch until it burned out. Afterwards he fired a rocket and worked at the pump. No assistance came, but by great good fortune the crew's sufferings were ended by their boat being thrown ashore on the sands between Irvine and Giles. The boat was lost, but the crew, though utterly exhausted, were able to scramble into safety.

## A Midlands Heroine

The latest awards made by the Trustees of the Carnegie Hero Fund recognised a number of brave deeds of remarkable distinction, but none of them is more noteworthy than that of Evelyn Neale, 12 years of age, of Smethwick. This small girl, at great risk to herself, rescued a boy from drowning in the Birmingham-Wolverhampton Canal at Smethwick, and her gallant action has been recognised by the presentation to her of an honorary certificate and a sum of £25.

## Railwaymen's Pluck

Three deeds of bravery and presence of mind have recently been reported on the L.N.E.R. Mechanic Fitter Ridgway was waiting at Finsbury Park Station when a boy about 10 years of age fell on to the permanent way in front of the 5.55 p.m. train just approaching. The locomotive of the train was only 20 ft. away from the boy when Ridgway jumped down and pulled him clear of the line, thus saving the lad's life. J. C. Lowe, a goods Guard, pluckily rescued a little girl who had fallen into the river near the Bridge of Allan. Lowe plunged into the water fully clothed and carried the girl to the bank, where he applied artificial respiration, which was successful. Carter William Martindale was passing a steam lorry in London Road, St. Albans, when his horse took fright and bolted, colliding with a motor and breaking one rein and the shafts. Hanging on to the other rein, Martindale stuck to his horse until thrown off his dray by a collision with a house. When the staff doctor attended to his injured leg he refused to absent himself from work and was on duty next morning as usual. These plucky actions have been reported to the headquarters of the L.N.E.R. who have highly commended them.



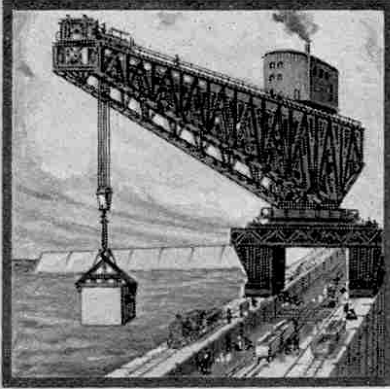

# Giant Block-Setting Cranes

## Their Work in Constructing Harbours and Breakwaters

(Concluded)

**A** PART from the designing, constructing, and the erection on the site of the cranes themselves, there are many other details to which the engineer must give attention. Take, for instance, the question of slinging the huge concrete blocks into position in the breakwater.

The least complicated form of hoisting arrangement for slinging concrete blocks is, of course, a simple clip or pair of jaws. There is a large number of designs of these, however, each design being suited for some definite purpose or for some particular conditions of work. Clips of this type depend entirely on friction, the general principle being that the direction of pressure between the clip and the block shall make an angle with the normal to the surfaces in contact, which angle is less than the angle of friction.

### Simple Friction Clips

In Fig. 1 is illustrated a form of clip that embodies this principle, in a type made by Messrs. Stothert & Pitt Ltd., for the Madras Harbour works. It consists simply of two hooks spanning the block, the hooks being hinged to a central connecting piece. By using connecting pieces of different lengths it is easy to arrange for the same clip to handle blocks of various sizes.

The releasing apparatus employed with this type of clip consists

of a second barrel on the lifting gear, the chain from which is connected to a stretcher frame. This is joined to the clips by short chains that take hold of the outer ends. Whilst the block is being lowered, the brake is applied to the second barrel at a given moment. This arrests the ends of the clips and when lowering is continued the outer chains take the stress, thus allowing the clips to open and slip and leaving the block detached.

A modified form of the same type of clip is shown in Fig. 2. In this form of clip—which, however, does not depend upon friction—the lower ends are hook-shaped, the hooks engaging in special recesses moulded in the blocks.

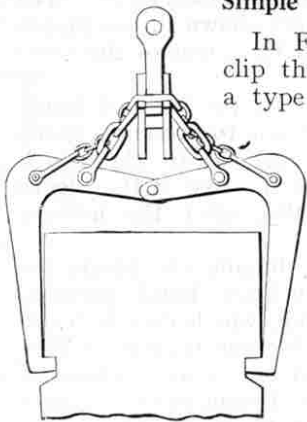

Fig. 2

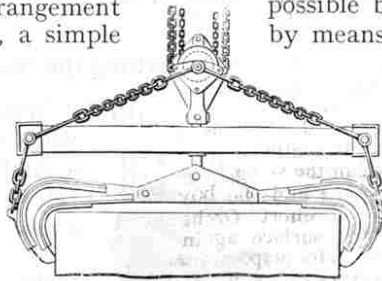

Fig. 1

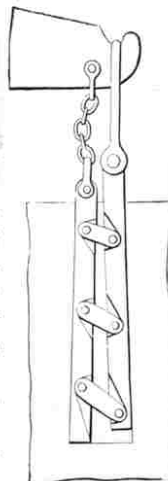

Fig. 4

### Rope and Lever Release

A friction clip of different construction, made to a French design and shown in Fig. 3, consists essentially of an arrangement of levers which procure a powerful pinch on the block. Here again adjustment is possible by setting the levers at different distances by means of the holes in the connecting bar, thus permitting blocks of varying sizes to be handled. An adjustment of this kind is very necessary in friction clips, because the actual range of movement of the clipping levers is not great, as the direction of pressure between the clip and the block alters considerably for a small motion of the levers.

Another effective block clip, illustrated in Fig. 7, was specially designed for placing in position the apron blocks at the harbour works at Mormugao. In this model the clips are released, and the block detached, by means of a rope controlling a lever, as shown in the side elevation in Fig. 8. This form of clip is shown in actual operation in the illustration of the giant Titan published on page 163 of our last month's issue.

### The Use of Lewis Bars

Another method of laying concrete blocks is the employment of two Lewis bars, provided with T heads at their lower extremities and loops at their upper extremities. The concrete block is suspended by them from a lifting beam, which is shackled to the lower eye of the bottom swivel of what is called a "Snatch Block."

In Fig. 5 is illustrated one method of carrying out this arrangement. The bars are shown passing through vertical holes cored out of the blocks, the T heads taking a bearing on pieces of hard wood placed in position when the block was moulded.

In the case illustrated the lifting beam has been made double so that the eyes of the Lewis bars may pass between the plates. Pins pass

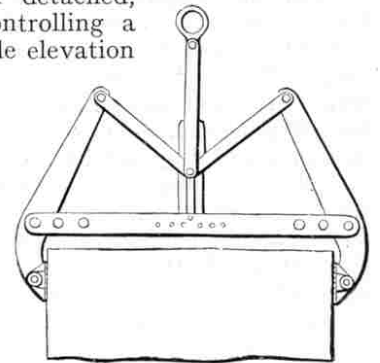

Fig. 3

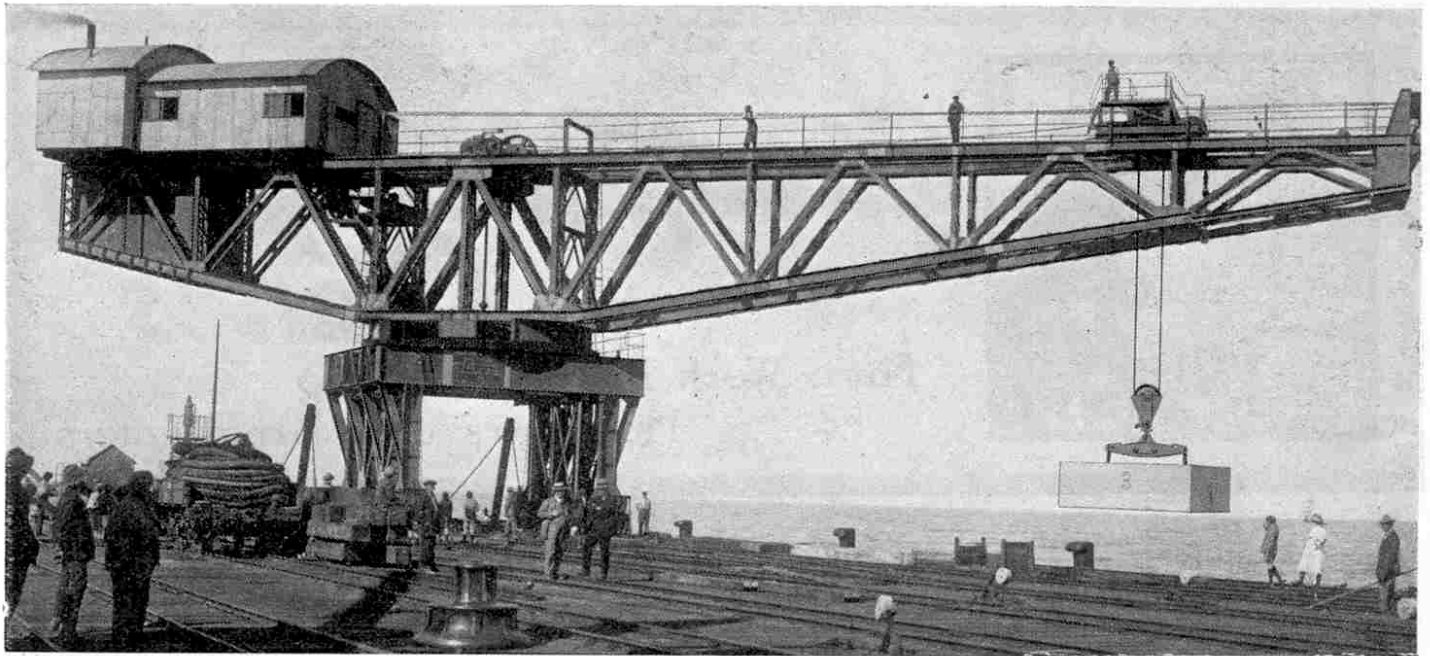

Photo courtesy]

[Messrs. Stothert & Pitt Ltd.

A 50-ton Titan Block-setting Crane at East London, South Africa

through the eyes and are borne in notches in the top edges of the side plates of the beam. The pins are retained sideways by shoulders and are chained to the lifting beam to prevent them from being lost.

When the block is lowered on to its bed, the bar is relieved of its weight. The pins are then withdrawn by a diver, and the Lewis bars are freed from the beam, which is then raised sufficiently by the crane to allow the bars to be twisted into position for withdrawal, a method now practically obsolete.

#### Self-Releasing Devices

Both the foregoing methods of employing Lewis bars require the attention of divers for underwater block-setting, or workmen for blocks above the water line. There are other forms of mechanism, however, designed to be self-releasing. One of these, illustrated in Fig. 4 and designed by Sir W. Matthews, K.C.M.G., necessitates a tapered hole in the concrete block. This hole is slightly cone-shaped, being narrower at the top than at the bottom. The lifting bar consists of two members, which are joined together, so that, to a certain extent, they resemble a parallel ruler.

When the block reaches the ground, the shackle carrying the weight becomes detached from the hook on the lifting beam and falls over. The crane-man then causes the crane to hoist. The lifting beam is thus raised and the chains pull on the short members of the Lewis. This is then automatically drawn close to the longer member by the closing up of the links recessed in both, and the Lewis is withdrawn from the hole in the block.

In order that the mechanism may be perfectly self-acting it has been found necessary to add a lever and weight to ensure the falling away of the loop from the bar at the critical moment.

#### Setting the Blocks at an Angle

All the forms of clips hitherto mentioned are employed when the blocks are to be set horizontally in a similar manner to that in which bricks are set in building a wall. In some breakwaters a more complicated setting is required, however, and the blocks are set at an angle—or, as it is technically termed, “on the inclined bond”—as will be clearly seen from the illustration on the top of page 55 in our February issue. The same fact is also strikingly shown in the breakwater in the distance on the cover of the same Magazine.

By setting the blocks on the inclined bond, the breakwater is made to present a much more formidable obstacle to the rough seas than would be the case if the blocks were set horizontally, after the manner of bricks in a wall.

The problem of slinging the blocks for setting on the inclined bond presents some little difficulty, which can be more easily appreciated by our readers if they construct a model of a crane and endeavour to set a small block of stone in the manner described. The problem is sufficiently difficult even with a model, but in actual practice it is more complicated for the blocks must be lowered to within an inch or even less of their exact position, and the movements controlled to a nicety, even though the weather may be stormy and there be heavy seas.

#### An Ingenious Mechanism

The difficulty is solved by an ingenious piece of Tilting mechanism called “Fidler’s Gear,” illustrated on this page. This mechanism consists of a massive beam hanging from a swivelling joint, the whole suspended (in the case illustrated) by a special

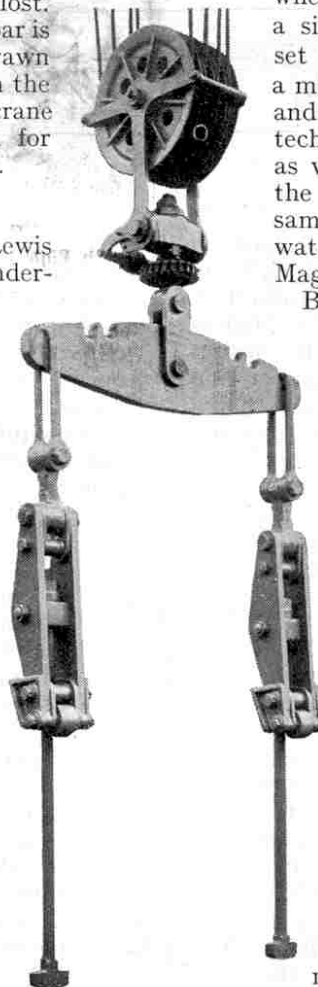

Fidler's Patent Gear



four-sheaved pulley. The rotating movement of the beam on the swivel is controlled by a special worm gear, which meshes with a pinion wheel on the vertical swivel bar.

A link hangs from the ends of each arm of the beam, which link supports steel cross-heads. From each of these cross-heads there hangs a long Lewis bar with a T end. Two perpendicular holes run completely through the concrete blocks. These holes are of sufficient width across one of their sections to take the T-shaped pieces at the end of the Lewis bars.

**Fidler's Gear in Operation**

What happens in actual operation is this. The concrete block is brought from the yard where it was made, on a special truck alongside the Titan crane that is to place it in position on the breakwater. The four-sheaved pulley with Fidler's Gear is lowered, and workmen guide the T-shaped Lewis bars through the vertical holes in the concrete block. When these completely penetrate the full depth of the block, the bars are given a quarter turn, which throws the T-shaped end out of register with the hole and thus prevents the rods being withdrawn. Shortly before the Lewis bars reach the bottom of the holes, the rollers on the steel cross-heads take a bearing on the top of the block and roll across, altering the relative positions of the points of suspension and the Lewis bars.

The signal is now given to the crane-man to hoist, and, the engine being started, the block is lifted at the exact angle at which it is to be set in position. The crane hoists the block, swivels round until the block is over its place in the breakwater, and then lowers it as is necessary. When the block rests on the breakwater, workmen turn the T-shaped rods until they are in register with the hole in the block, and the crane again hoisting, the Lewis bars are easily withdrawn, leaving the block in position set at the correct angle.

**How Cranes Help Trade**

In our last article we gave particulars of the giant Titan cranes used in the construction of breakwaters, which article followed a description of Goliath cranes similarly employed. We illustrated a huge Titan that was built for the Union of South Africa and was erected at Port Elizabeth for work on the breakwater and harbour there and we gave full particulars of this remarkable machine, including details of the mechanisms. On page 222 we are illustrating another huge Titan, erected and in use at East London, S. Africa.

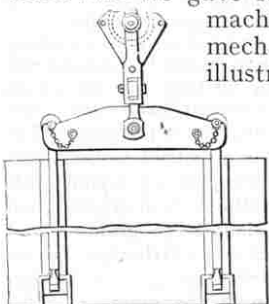

Fig. 5



Fig. 6

Similar cranes of this type have been employed in the construction of some of the best-known harbours of the world, and they have played a very important part in

the development of the Empire. Take, for instance, the case of Port Elizabeth, a seaport town some 400 miles east of Cape Town. This is the second city in the colony and is situated on Algoa Bay, about 7 miles south of the mouth of the Zwartkop River. It is built along the base and up the rocky slopes of hills that rise to a height of 200 ft. above the bay.

The Port entirely owes its prosperity to its harbour and it has become the centre for the trade of the whole of the interior of the country lying to the south of the great Zambesi. Previously there were no convenient landing places and so it was impossible for ships to load or unload. Some improvements in this respect were made in 1881 when the old pier was extended to a total length of 900 ft. and a second pier 800 ft. in length was constructed. Since that date even more extensive works have been carried out, and the harbour is now one of the finest in South Africa. Port Elizabeth is only one of dozens of similar instances of how Giant Block-setting Cranes help trade.

This series of articles may well be concluded with a reminder that although progress in engineering has been extremely rapid in all directions in recent times, the development of great sea-works has been one of the most striking features in the history of engineering. We have only to remember that at the beginning of the 19th century London had not a single dock, whereas to-day there are miles and miles of docks; that the docks at Cardiff, Newport, Barrow, Middlesbrough and at many other places did not then exist; that even as late as 1816 Liverpool had only 16 acres of dock area, and that Hull and Grimsby were no better than fishing ports, as far as their dock accommodation was concerned.

Take our survey further afield, we find that the breakwater at Table Bay was not commenced until 1860; that until 1875 Calais Harbour had only 2½ ft. of water on its bar at low water; that Colombo Harbour was not commenced until 1870; that Dover was not selected as a site for a great port until 1845; that the breakwater at Newhaven was not started until 1878—and so we might extend the list indefinitely, showing that during the past century work in connection with harbour construction at home and abroad has gone forward by leaps and bounds, and has played a greater part than anything else in the development of civilisation in general and the world's trade in particular.

More than once it has been pointed out that when he has completed his work, the harbour engineer has not a great deal to show but long sea walls or stone platforms abutting from the shore. Although this may at once be admitted as a fact, we must remember that it is in the skill required for the building of these



Fig. 7

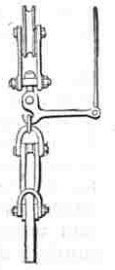

Fig. 8

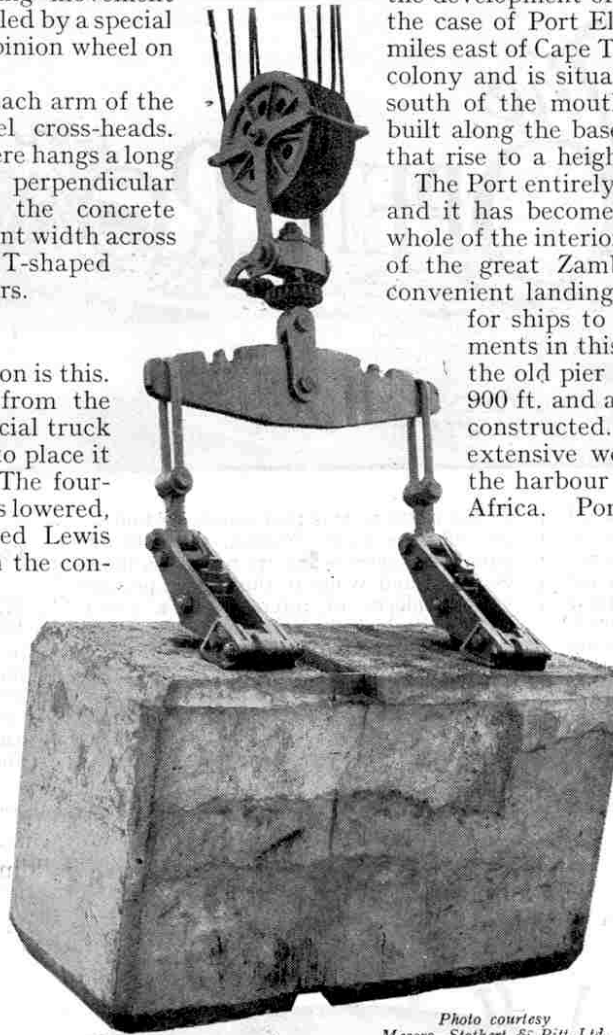
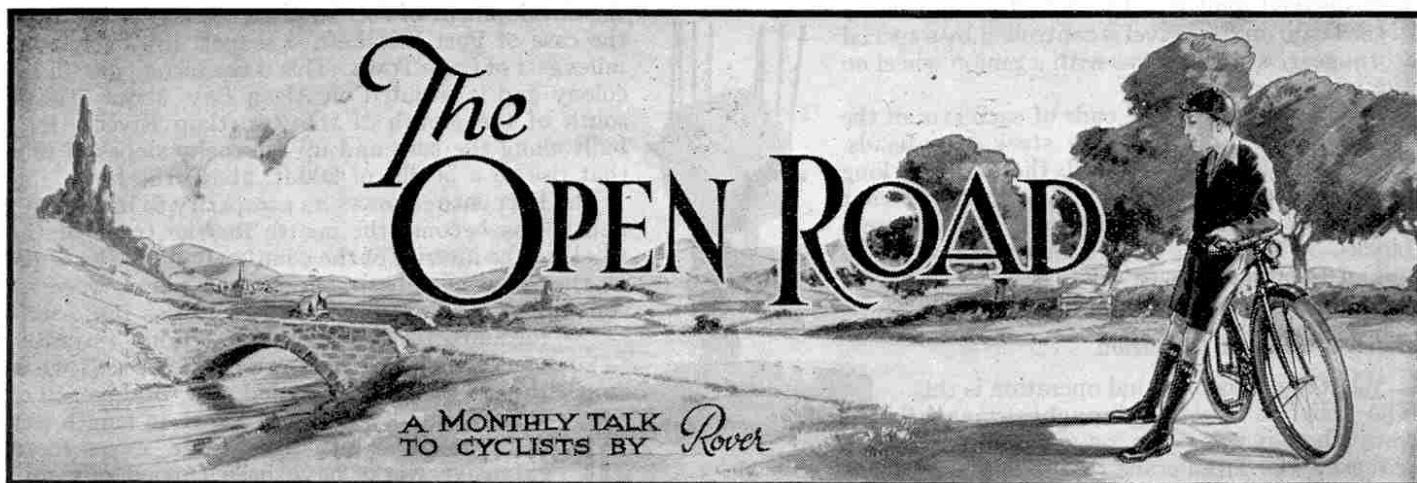

Photo courtesy Messrs. Stohert & Pitt Ltd.

Slinging a Concrete Block with Fidler's Patent Gear

(Continued on page 235)



FROM the letters that I have received since the publication of my notes last month, it is clear that a large number of my readers have learned for the first time of the joys of touring on their bicycles. It is evident also that hundreds of these same readers are now planning tours—some of only a day's duration and others, more ambitious, extending over several days.

#### A Few Suggestions

Quite a large number of readers write asking for definite suggestions for tours. As the subject is of general interest I propose to reply briefly to these enquiries in this article, and to deal with one or two other points that have also been raised. In the near future I shall describe more definitely a particular tour, starting from Bristol, that I made a little time ago and in order that I may refresh my memory on some points, I intend to cycle over the ground again next month.

Well, now, in regard to definite suggestions for touring. In this country we have endless objects of interest, quaint links with the past, and any amount of magnificent scenery that can only be seen by the tourist. No matter whether my readers live in the north, south, east, or west, they can plan any number of delightful tours, and I will warrant that the memory of these tours will remain with them for many a long year.

In the south, for instance, there are the glorious Kent lanes, the Surrey hills, and—to the west—the moors of Devon and Exeter. A little further north from this last-named ground lie Wells, Glastonbury, and Cheddar Gorge, in the centre of a district full of interest and romance. Still further north is the beautiful Wye Valley, with Stratford-on-Avon and the Shakespeare Country, a great attraction for all American tourists, close at hand. In the north of England there are the dales and moors of Yorkshire, with fine roads running alongside the bracing east coast.

To the north-west is that wonderful touring ground, the Lake District, with its unequalled scenery—and its notorious hills! Scotland and Wales in themselves provide enough places of interest for a dozen tours, with historic castles and abbeys and magnificent scenery.

#### Camping on the Dee

Apart from "district" tours, there are many interesting towns that can well be made the objective of a tour. For instance,

Kipling says, in one of his books.

#### Consult Guide Books

Another fine old city is Lincoln, where William the Conqueror built his Castle in 1068. The ancient Cathedral, commenced in 1092, has recently been before the public eye, because of the cracking of its walls and the engineering efforts that have been made to save it from collapse. There are many other interesting relics here, and although Lincoln itself stands on a hill, the surrounding country is very flat and does not therefore call for so much exertion as hilly Yorkshire, Wales, or Scotland!

I could "go on all day," as the saying is, describing countless interesting and beautiful spots in all parts of the country, but space forbids. These are but two examples of interesting towns that might well be made objectives of two tours. It behoves every reader to look around for himself and select a suitable touring ground. In case of any difficulty visit your local reference library, where you will find a mine of information in the numerous guide books available.

Whatever town or district may be your destination,

or however short or long may be your tour, remember the advice I gave last month and do not plan to ride too far each day. Take things comfortably and instead of trying to "pile up the miles" and see how much ground you can cover, "go easy" and make your tour a really enjoyable and health-giving holiday.

There are two ways of making a cycling tour. The first is to decide beforehand the places you intend visiting and the exact distance to be covered each day, and "riding to schedule," as it is called. The second is to choose a district to tour, and to visit each day the places you think will prove most interesting. You are not then tied down by a definite programme and can spend as much or as little time as you wish at any particular spot, according to the inclination of the moment. This

## No More Punctures!

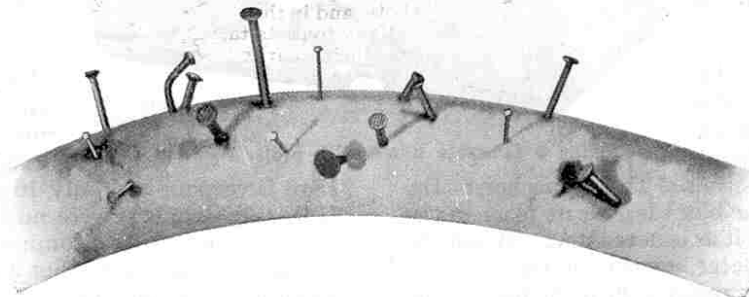

We reproduce this interesting photograph to show the remarkable immunity from tyre trouble that results from the use of a good puncture-sealing solution. The inner tube shown was treated with "Fibermetic" solution and inflated to ordinary riding pressure. Several nails, tacks and pins were then pushed into the tube as shown, but in spite of this drastic treatment—more severe than is likely to be met with on the road at any time—the tube held up perfectly. There was no escape of air, which fact shows clearly that this puncture-sealing solution does its work effectively.

Chester, surrounded by its ancient walls—some two miles in length—inside which are to be found a beautiful Cathedral and an ancient Castle. Here also are the "Rows," or covered galleries paved with flagstones and level with the first floor of the houses, where pedestrians may walk above the level of the street. Across the Dee is the second largest stone bridge in the world and there are also numbers of old buildings, such as the "Bear and Billet" Inn, at one time a mansion belonging to the Earls of Shrewsbury.

There is splendid boating and fishing on the River Dee, and one can canoe for over 70 miles up the river. A few days spent on the river, camping out on the bank at night, would form a very enjoyable extension of a cycling tour, the bicycles being left at the boat-house—however, "that is another story," as



# No More Punctures



Stop tinkering with tyre levers, messy solutions and patches. Send a P.C. for this booklet which tells how to end puncture mending for ever. It's

# Free

to Meccano Readers.  
Address:  
**JACKSON'S IMPERVO SALES LTD.**  
(Dept. 31a) 48, Dover St., LONDON, W.1

## GRAVES WORLD'S BEST CYCLE.

World's Best Value. Every component part of guaranteed excellence

**HANS RENOLD CHAIN;**  
**BRAMPTON'S HUBS; B.S.A. FREE WHEEL; BOWDEN BRAKES; SPIRAL SPRING SADDLE; HUTCHINSON'S EXTRA PARA SUPER CORD TYRES; DUNLOP WESTWOOD RIMS; £6:10:0**  
Lady's Model same price

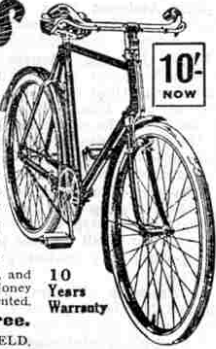

Terms: 10/- with order, and balance 10/- monthly. Money back if in any way disappointed.  
**Catalogue Post Free.**  
I. G. GRAVES Ltd. SHEFFIELD.

## A Veeder Cyclometer

FITTED TO YOUR BICYCLE TELLS YOU:—

- How far you have been;
- Distance from one place to another;
- Service your Tyres give you;
- Number of Miles to Destination;
- Distance Travelled, etc.

Makes your Riding doubly interesting. Its accuracy has been endorsed by all the best authorities and the experience of your fathers for 26 years.



Insist on a Genuine Veeder. Beware of German Imitations. Made in Two Models: Regular 6/6. Trip 15/-.

Markt & Co. (London) Ltd.  
98-100, Clerkenwell Rd., London, E.C.1.

## A FEW PENCE a day BUYS a 'ROYAL WINGHESTER'



SAVE DEALERS' PROFITS. Buy direct from actual makers at Wholesale Factory Prices. Small deposit and the cycle is yours, Packed Free, Carr. Paid, 14 Days' Free Trial Approval.

**Amazingly Easy Terms**  
Full satisfaction or money back. Write for Monster BARGAINS Book. ABSOLUTELY FREE. Cycles, Tyres and Accessories at truly Dumbfounding Prices. Write TO-DAY to

**MOORHOUSE LTD.**  
DER 60 Padiham, BURNLEY

method is, I think, much to be preferred, for more reasons than one.

### Clothing and Equipment

The first question, after deciding where to go, is what clothing and tools, etc., are necessary. Equipment should be cut down to the absolute minimum in order to reduce weight, and with this in mind it soon becomes not so much a question of "What shall we take" as of "what can we do without."

To a large extent, of course, the outfit depends on the length of the tour. For instance, on a tour of a few days only, practically no spare clothing need be carried. On a longer tour, a change of under-clothing and clean stockings and collar are desirable, although if one wishes to travel light, it is a good plan to post these on to some address in advance, and pick them up on the tour. Perhaps the most suitable clothing for a cycling tour of any kind is a sports coat, shorts, and cycling stockings, with a cycling cape strapped on the carrier.

If the plan is for a camping-out tour, then there will be the waterproof sleeping tent, to which reference was made last month, and a light saucepan or kettle for boiling water. It may be decided to carry a "pocket" oil stove—this does not weigh much, and is certainly an advantage in case no fuel can be found when it is time to make tea. However—the whole question of equipment is largely one of "ways and means," which each reader will be able to settle to his own satisfaction.

In regard to the machine. A complete tool kit, a pump, and puncture repair outfit should be carried. If more than one is touring, probably one tool kit, pump, etc., will serve both, and in this way weight will be saved. Many tourists take a spare inner tube with them, carried wrapped around the handle-bar, but unless the tour lies off the beaten track this is not very necessary, as inner tubes may be bought almost anywhere these days, should an emergency arise.

As previously mentioned, the bicycle itself should be given a complete overhaul before commencing the tour. All bearings should be well greased, the chain cleaned and oiled, both brakes put into working order, and the lamps trimmed and filled.

### Care of Tyres

Perhaps the most important part of the machine, so far as an enjoyable tour is concerned, is the tyres, and no cyclist who intends setting out on tour should neglect them. A rider who treats his tyres with proper care will invariably be repaid by getting from them an increased mileage. No oil or grease should

be allowed to touch the rubber, and the fabric should never be damp or wet. Small pieces of grit or stones should be removed immediately from the covers, and all cuts should be repaired as soon as possible, with the special "tyre-stopping" supplied for the purpose. This is sold in small tins and consists of rubber composition, which, though plastic when the tin is opened, soon solidifies when exposed to the air. First, the cut in the cover is thoroughly cleaned and any grit or flints carefully extracted with a blunt instrument. A small portion of the tyre-stopping is then pressed into the cut until it is filled. The stopping is then allowed to set and in this manner the cut is filled, very much after the style in which a dentist "stops" a tooth.

Equally as important as filling the cut is to clean and repair the canvas of the outer cover. The filling of the cut serves only to make it waterproof and cannot be expected to prevent the inner tube from blowing through the hole—this is the function of the canvas.

If an outer cover is showing marked signs of wear it is wise to replace it by a new one if possible, before going on tour, keeping the old cover for local runs. Naturally there is always more wear on the back tyre, and very often a cover that shows signs of wear will do long and useful service on the front wheel, whereas it might be a continual source of trouble on the back wheel.

### All-Weather Machines

In order to be prepared for rain during a tour many cyclists protect the plating of a new machine by covering it over with a thin layer of petroleum jelly. Although this treatment means that all mud or dust is retained by the grease, the advantages are great, for in fine weather the whole mass can be quickly removed, revealing the clean and brilliant plating beneath. Other riders prefer to convert their cycles into all-weather (all-black) machines by enamelling the plated parts, such as the handle-bars, wheel-rims, chain-wheel, pedals and cranks. This treatment saves considerable time in drying and polishing after a wet run and also prevents pitting and rusting. Before these plated parts will take enamel, however, they must be treated with a suitable metal size, which should be applied first and allowed to dry. Then the whole machine may be enamelled at one operation.

## NEXT MONTH:— HOW TO READ A MAP

**Don't be Let Down by Punctures!**  
Use FIBERMETIC for your Cycle or Motor Cycle Tubes, and NEVER be let down by PUNCTURES. Instantly stops air leaks up to 1/4-inch. Non-injurious to rubber and does not choke up valves. Never goes bad—Never stops functioning.

# The Permanent Fibermetic PUNCTURE SEAL

<b>TWELVE MONTHS' ABSOLUTE GUARANTEE</b>	FIBERMETIC is sold in Tins 1 lb. 3/6, 2 lb. 7/- Post Free. Please state if for Cycle or Motor Cycle Tubes. Trade Enquiries Invited.	<b>£100 PAID TO ANYONE DISPROVING OUR CLAIMS</b>
--	---	--

**THE FIBRINE SALES LTD.**  
Embankment Chmbs., 19, Villiers St., Strand, W.C.2.

When you are purchasing a New Bicycle, remember it pays in the long run to buy a good one

**Humber from £6:17:6**  
**Raleigh (All-Steel) from £7:12:6**  
**B.S.A. from £6:17:6**

All on Easy Terms

**Genuine Fairy Cycles, 49'6**

Arundel Cycle & Sports Stores,  
58, CHURCH RD., UPPER NORWOOD, S.E. 19

# OUR BUSY INVENTORS

## RECENT INTERESTING PATENTS

Every day new inventions and ingenious labour-saving devices are being brought into existence. From time to time the most interesting of these will be described and illustrated in these columns. Readers are invited to send particulars (accompanied, if possible, with photos, sketches, or cuttings) of any interesting inventions or devices that may come to their notice. Payment at our usual rates will be made for any contributions used.

### Thief-Proof Keys

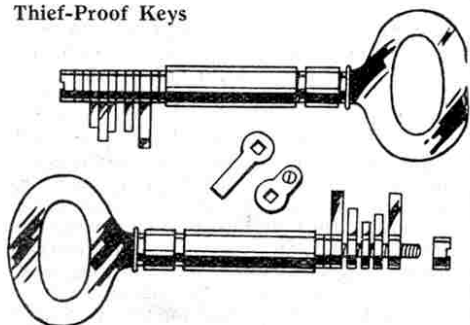

A new form of thief-proof lock and key, said to equal the famous Yale locks in ingenuity, has recently been patented in Germany. To enable a change to be made from one adjustment to another, lock and key are fitted with an arrangement of loose teeth. Thus the levers and springs of the lock may be set in several different combinations known only to the owner. The key has a corresponding number of sliding teeth that may be arranged in an almost endless number of positions.

### Self-Adjusting Wrench

The inventor of this powerful but simple pipe wrench has arranged the jaws so that the more pressure placed upon them, the firmer is their grip. The wrench instantly adjusts itself to any width within the limits of its jaws, and as it cannot slip it will not throw its user backwards during a hard pull. The manner in which it grips permits the wrench to be used in many places inaccessible to ordinary wrenches. Instant adjustment is obtained by means of a spring as shown in the accompanying illustration, and an ingenious arrangement of joints connects the two jaws.

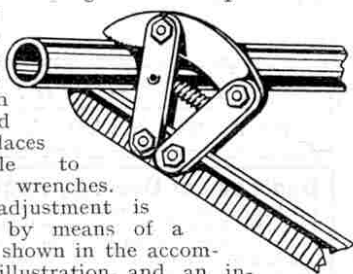

### A "Weather Glass" in a Hat

Boys are well known for their dislike of carrying umbrellas unnecessarily, and Meccano boys are no exception to this rule. A new form of hat that will give an accurate forecast of the weather should, therefore, be particularly popular. Beneath the crown of this strange hat is pasted a piece of blotting-paper that turns blue when clear weather is promised and pink when rain is due. The secret

of this handy weather prophet lies in the fact that the blotting-paper is treated with a solution of one part of cobalt chloride, ten parts of gelatin, and one hundred parts of water, cobalt being extremely sensitive to variations of moisture in the atmosphere.

### An Expanding Hammer

A hammer with moveable vice-like claws is an invention that should prove popular among carpenters and handymen, as it is capable of pulling even the most stubborn and headless nail. The claws



are pivoted  $1\frac{1}{2}$ " from their ends and in gripping a nail they spread apart when pushed toward the handle. Then, when they are straightened by a pull on the handle, they are forced into the wedge-shaped opening of the bearing shoulders, thus tightening the hold on the nail in proportion to the force required to draw it. A spring in the head of the hammer automatically re-adjusts the claws when the nail is removed. Should the jaws be damaged they may be replaced by new ones in a few minutes.

### A "Solder Pen"

An electric soldering iron, which is no larger than a fountain pen and enables soldering in difficult corners to be easily

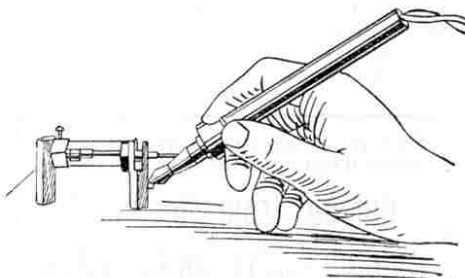

accomplished, should prove particularly interesting to all amateur engineers and wireless enthusiasts who construct their own sets. The tool is said to be the smallest and most efficient soldering iron yet made and is already in great demand, particularly in America. The "Solderpen" has a platinum heating unit and soft wire solder is used on small work.



## BRIGHT IDEAS

This column is reserved for dealing with suggestions for new parts, new models, and new ways of making Meccano model-building attractive.

**V. Hughes** (Middlesboro).—We list a Threaded Coupling (No. 63c) for joining a plain Rod to a Threaded Rod.

**R. D. L. Darly** (Ealing, W.).—It is a fairly straightforward matter to arrange the construction so as to obviate the coupling when joining two rods interfering with any other part of the mechanism. We think that your screw method of joining rods would be costly and somewhat difficult in view of the narrow diameter.

**Jack Andrews** (Box Hill, Victoria, Australia).—Practically all the railway accessories you mention have recently been introduced.

**Frank Johnson** (Mansfield).—(1) Elongated holes on both flanges of Angle Girders would be a disadvantage rather than otherwise. The present type takes care of two functions (a) to provide adjustment by means of the elongated holes on the one side and (b) the single holes for rod bearings. (2) A 1" reversed angle bracket may be formed by bolting two existing 1" angle brackets together.

**S. Sylvain Knecht** (Algiers).—(1) Do you consider a 3½" slotted strip has any advantages over the 5½" slotted strip? Up to the present we have not experienced any call for this particular size. (2) A flat sector plate may contain possibilities which we shall examine.

**F. Francois** (Viviers, France).—We agree that perhaps the bearings of the armature shaft of the 4-volt motor are not quite as broad as they might be, but a simple reinforcement may easily be effected by the bolting of one or two extra strips to the side plates.

**L. O'Brien** (Johannesburg, S.A.).—We do not think that a six-holed bush wheel would fill any definite requirements. Up to the present the necessity for this particular part has not been apparent.

**Tom Fish** (Gunthwaite, Yorks.).—We have devised a clutch mechanism for the model chassis and this is now in course of publication.

**J. Crebassol** (St. Martin de Villerglan).—Much regret, but we do not follow your suggestion in connection with the bush wheel. A sketch would be helpful.

**M. Paquier** (La Chapelle St. Mesmin, Loiret).—(1) A flat sector plate has already been suggested (see above). (2) We shall have to examine carefully the adaptability of the various sizes of reversed angle brackets and curved strips you mention. (3) We already list a 25 mm. bolt. As far as the 38 mm. and 5 cm. bolts are concerned, we think the threaded rods would serve the same purpose. (4) A 5 cm. flanged wheel may be obtained by bolting the small flanged disc to the face plate.

**J. Candles** (Tulse Hill, S.W.).—The functions of the right angle flat bracket are taken care of by the existing corner bracket.

**R. Lacombe** (Chateauroux, Indre).—We have not yet found any uses for an interior-toothed gear wheel. Its introduction for one specific use would not be justified.

**H. Stewart** (Glenferrie).—We have found that the cam made up from Meccano parts and used on the loom works quite satisfactorily. A specially constructed cam for this model would have no use in other directions and we endeavour to avoid the duplication of elements. Regarding your observations on the shuttle, this element obviously does not lend itself to construction from existing parts.

**A. Langois** (St. Sauveur-Levasville).—We are considering an increase in the variety of bevel gears.

**Ch. Waldschmidt** (Dunkerque, Nord).—Grub screws are obtainable separately and are listed in the accessory list under numbers 69a and b.

**J. Vincent** (Basse-Tutz, Moselle).—(1) Regret we do not follow your suggestion in connection with the threaded wheels. Perhaps you would give us a little further explanation. (2) At the moment we are engaged on a suitable sliding gear.

**J. Palmer** (Norwich).—We are exploring the possibilities of a worm wheel with a wider pitch.

**W. Cheary** (Forestable, S. Australia).—(1) We are afraid that the present Meccano nut is not suitable to permit of its being adapted to the wing or butterfly type. In any case we think that, in many cases, the wings would prove an obstruction. (2) Your suggestion for deepening the grooves on the pulleys is sound and we shall look into the matter. (3) The alterations or additions you suggest to the No. 2 Hornby Loco. are more in the nature of extra finish, to which we shall probably work up in due course.

**N. Batham** (Farnworth).—The Hornby series of accessories is by no means complete. We have several new and interesting items in course of preparation.