

Motor Co., Birmingham. I consider this entry of such general interest that I intend to make it the subject of a special article in a coming issue of the "M.M." and therefore I do not propose to describe it here, except to mention that among the new principles in design incorporated in the model, is a device that allows a difference in front wheel level of 1½" to 2". This is a point of considerable importance in the case of motor lorries that have to travel over rough ground, and the actual vehicle has been subjected to very severe tests by the War Office through which it passed with high honours. As I am sure every Meccano boy will be interested in hearing more of this unique vehicle, I advise readers to watch out for the special article, in which both the prototype and Garner's prize-winning model will be illustrated and described.

This contest produced two of the finest specimens of Meccano model-building that it has yet been my pleasure to receive in any contest. I refer to the two models entered by J. B. Frost and which are illustrated in the accompanying composite. The first of these is a splendid replica of an Aero Morgan three-wheel car and I think all readers will agree that the model is most realistic. Its most outstanding quality lies in the excellent manner in which each part used in its construction has been utilised. Although the most minute details of the prototype are represented, the appearance is nevertheless most pleasing in outline—a point of considerable importance, for in many models of this type the main features are submerged in a mass of ill-proportioned detail.

There is a vast distinction between building a model including an abundance of detail, and building a pleasing model in which the minor features are correctly proportioned, and it is only by using parts best adapted to the purpose that success may be attained. To accomplish this, naturally demands an extensive and thorough knowledge of the uses to which each part may profitably be employed in a model.

Unfortunately, however, a technical error has been made in designing the car, for it will be noticed that the model is equipped with a water cooling radiator, in accordance with the latest practice of the Morgan Coy., and the cylinders should therefore have smooth-sided walls. Frost has overlooked this point and provided air cooled cylinders of the ordinary radiating fin type. This slight inaccuracy is to be regretted as otherwise it would have been hard indeed to find fault with the constructional details of the model.

The three views of the model show fairly clearly all the items of importance. The engine fitted with overhead valves, the cylinders complete with ignition plugs, and the exhaust pipes, are features worthy of special notice.

The ¾" Flanged Wheels secured in the ends of Sleeve Pieces afford very realistic silencers, while the fish tail exhaust pipe enhances the finished effect. The constructional details of the

steering gear constitute an object lesson in refinement in model-building. Meccano boys should study this model carefully.

All that can be said of this model may also be applied with equal justification to Frost's other entry; a rotary type aeroplane engine. Particular notice should be given to the manner in which the cylinders have been devised from 1" loose Pulleys and Chimney Adaptors, and the realistic appearance of the exhaust pipes, that are reproduced with Meccano Springs. A further feature of unusual interest is the use of the shanks from Spring Buffers, to imitate the sparking plugs. The model is constructed entirely from standard parts, although a first glance is inclined to induce one to believe otherwise.

Eric Whalley's entry takes the original form of a model Vertical Drilling Machine and provides an excellent example of the educative value of the Meccano system when used for constructing mechanisms of this kind. The model is patterned on the type of machine manufactured by Archdale Limited (Birmingham) for use in foundries and general engineering machine shops. A wonderful gear box is fitted that gives a range of nine different speeds of the drill mandrel and a separate gear box is provided for driving the spindle feed mechanism.

This latter gear box is mounted at the right-hand side of the spindle and incorporates two speeds either of which are brought into operation by movement of a crank lever, conveniently situated. The gears give cutting ratios of 1" per 75 revolutions and 1" per 50 revolutions, of the drill spindle. Another lever throws the main drive out of gear so that it is possible to bring a secondary drive into operation for very fine and sensitive drilling work. A friction clutch operated by a lever stops or starts the machine at will.

The drilling table, which is of the revolving pattern, rotates on a pin, and the table support is so arranged that it may be swung out of position in order to accommodate bulky work which is placed upon the base plate of the machine and the drill spindle adjusted accordingly. Both the table and base plate are fitted with inverted "tee" angle-slots so that "tee" bolts may be used to clamp the work to be drilled in position.

The framework of the machine is solidly constructed from Angle Girders braced efficiently with Strips and the mechanism, which, by the way, is situated mostly at the upper part of the machine, is encased with various Flat Plates that not only afford protection to the gears, etc., but also enhance the appearance of the finished model. Whalley is to be congratulated on his very praiseworthy effort.

A well built and unique model of a counterbalanced drawbridge (illustrated herewith) brought success to Clement Wilson, who informs me that his entry is a reproduction of the temporary Haven Bridge that spans the River Yare at Yarmouth. The constructional details of the single leaf, winding gear and movable counter-balance are shown clearly in the photograph.

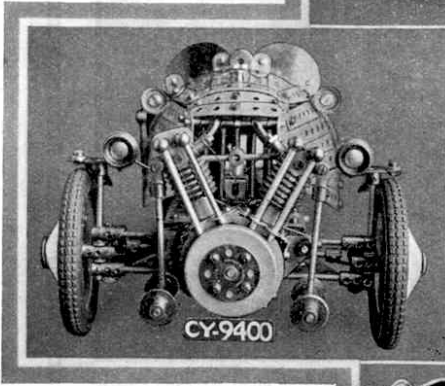
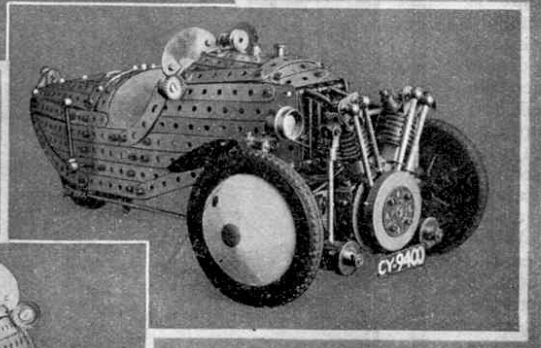
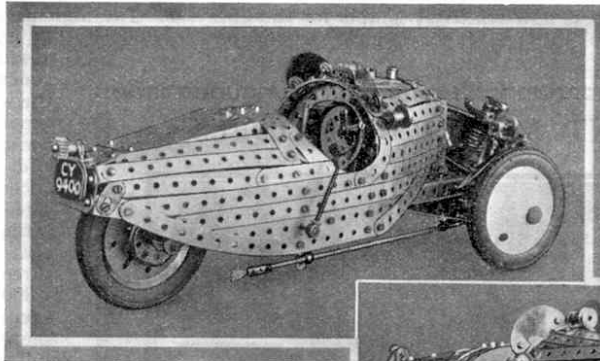

Top (two views) and left : J. B. Frost's model Aero Morgan.

Right and Bottom : Two views of the fine model rotary type Aeroplane Engine built by J.B.Frost.

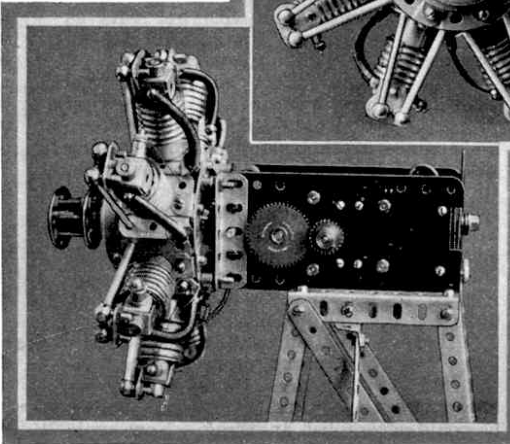
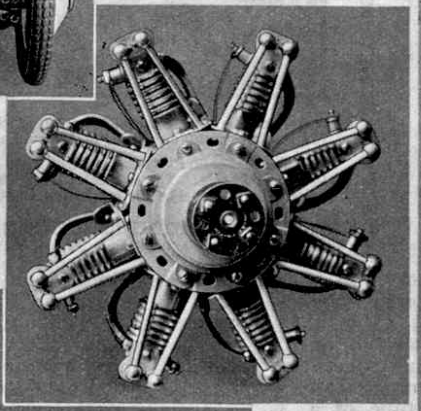

A Four-Wheeled Morgan

One of the most distinctive British small cars introduced this year is the attractive "Morgan 4-4" two-seater shown in the upper illustration on this page. The car is unusually low in build and has a graceful sporty bonnet and a tail streamlined to match the contour of the rear wings. Independent front wheel springing based on that used in the Morgan three-wheeled car, the Stevenson jacking system, and Girling brakes are other features of the chassis. The engine is a 9.8 h.p. Coventry Climax water-cooled unit fitted with overhead valves, and transmits its power through a single-plate clutch and an enclosed shaft to a four-speed gear-box, with synchromesh for easy changing on third and top gears. The car has a wheelbase length of 7 ft. 8 in. and an overall length of 11 ft. 8 in.

Britain's Great Motor Industry

We are so accustomed to the sight and use of motor vehicles that perhaps few of us realise the enormous part the motor car manufacturing industry plays in the life of the country. Nearly 500,000 workpeople are employed in the actual manufacture of motor vehicles, and if others engaged in the driving and repair of vehicles and in allied engineering and body-building trades also are taken into account, the number of employees connected with the industry reaches well over a million.

The value of the motor products manufactured in England during 1935 was over £15,000,000. Last year 311,544 cars were produced, and it is anticipated that during the present year this number will be exceeded by over 50,000.

New Racing Track in South Africa

Preparations are now being made for a great motor race that is to be held in South Africa on 16th January next year. Drivers from England are being invited to enter, and the race will be run over a new track, now under construction at Muizenberg, near Capetown, which will be one of the finest of its kind in the world. It will include ample pits and a road racing circuit with interesting bends and corners, and there will be accommodation for many thousands of spectators.

Racing at Donnington Park

Very soon now the motor racing season will be ended, and the exhausts of cars flat out on road or track circuits will not be heard again until next spring. A few important fixtures still remain to be decided, however, and of these probably the most interesting is the International Grand Prix, which is likely to provide plenty of excitement for spectators at Donnington Park on 3rd October. Both supercharged or unsupercharged cars are eligible for this race, provided that they have suitable types of open bodies, four wheels and fulfil all essential racing requirements. The race will be run over 120 laps of the Donnington Park course, which is about 2½ miles in length, thus making a total distance of 300 miles; and a prize of £250 is offered to the winner. Last year the race was won by R. O. Shuttleworth, who drove an Alfa-Romeo. His average speed was 63.97 m.p.h.,

and he was closely followed by a Bugatti driven by Lord Howe.

As the race is open to foreign racing drivers, it is hoped that some of the famous Continental "aces" will take part in this year's event.

The Manx Grand Prix Races

The Manx Grand Prix Junior and Senior races, which are run over a 226 mile course in the Isle of Man, never fail to provide thrills for the thousands of spectators who line the course. The outstanding feature of this year's races was the remarkable riding of Austin Munks, an engineer of Boston, Lincolnshire, who won both the Junior and the Senior events. This is the first time the two races have been won by the same competitor since E. N. Lea accomplished the feat in 1929, and Munks's great performance is made all the more remarkable by the fact that he has the sight of only one eye. In the Junior Grand Prix he rode a Velocette and completed the 226 miles

in 3 hrs. 3 mins. 47 secs. at an average speed of 73.92 m.p.h. Only seven seconds behind him was J. H. Blyth on a Norton, who averaged 73.88 m.p.h.

Simultaneously with the Junior Grand Prix a light-weight race was run for a trophy presented by relatives of D. J. Petrie, who was killed in a T.T. race last year, and this was won by D. Parkinson at a speed of 65.68 m.p.h., his machine being an Excelsior.

In the Senior Grand Prix Munks rode a 490 c.c. Norton, and the race was a keen duel between him and J. H. Blyth, also on a 490 c.c. Norton. Munks covered the six laps of the 226 miles course in 2 hrs. 52 mins. 14 secs., at an average speed of 78.88 m.p.h. Blyth finished 10 secs. later, his time and speed being 2 hrs. 52 mins. 24 secs. and 78.80 m.p.h. respectively.

K. Bills on a Norton, the fourth rider to start, was the first to complete the first lap, which he covered in 4 secs. under 29 mins., at an average speed of nearly 79 m.p.h. When Munks came roaring past the grandstand his time was six seconds more than that of Bills, who thus held the lead, but in his second lap Blyth averaged 78.85 m.p.h., and became 6 secs. ahead of Bills. During this lap Munks was even faster than Blyth, however, and his riding thrilled the crowds as he took corners at a tremendous speed. He finished his second lap 7 secs. ahead of Blyth, and then maintained the lead until the end of the race.

There was considerable excitement in the closing stages when it was learned that Munks'

petrol tank developed a leak while he was on his fifth lap, and he had to stop to refuel. By the time he had restarted Blyth and several other riders had finished the course, and there was a thunderous cheer from the crowd when the red light over Munks' number on the score board showed that he had reached Governor's Bridge, less than a quarter of a mile from the finish. He had scarcely flashed past the finishing line before the timekeepers had worked out their calculations, to show that Munks had won by 10 seconds from Blyth. It was revealed after the race that there was less than a quart of petrol in the tank of the winner's machine when he reached the end of the course.

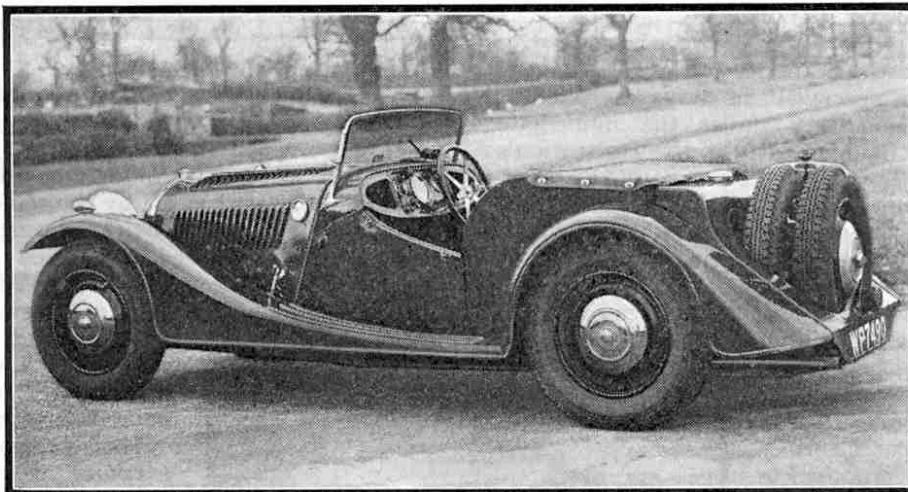

The distinctive "Morgan 4-4" sports car referred to on this page. Photograph by courtesy of The Morgan Motor Co., Ltd., Malvern Link.

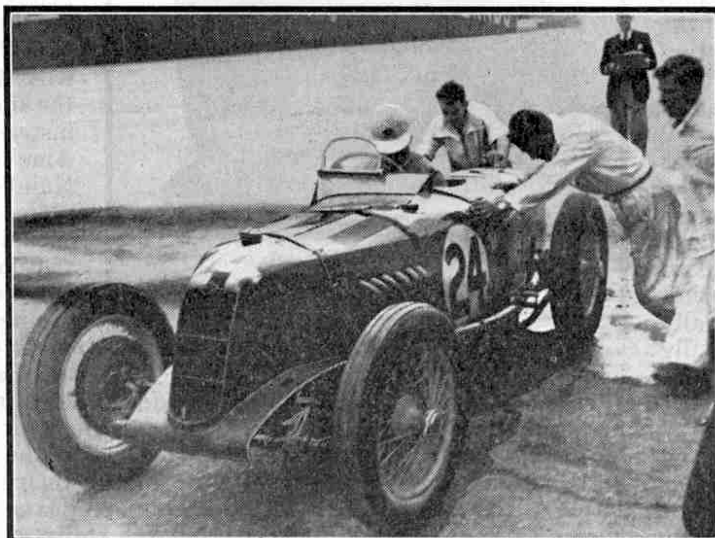

A scene during the British Racing Drivers Club 500-Miles Race last year. A Riley that was second in the race being started from the pits after refuelling. Photograph by courtesy of Riley Record Limited.

A WHIFF OF BY-GONE TIMES

Spanner describes two models that capture the lines of two classical sports cars, now almost extinct on today's roads

PERHAPS IT'S my imagination, but cars, these days, seem to be growing more and more alike. Different makes can sometimes quite easily be confused and even sports cars are beginning to look like saloon cars or vice versa. It hasn't always been like this, however. In times gone by, a saloon car was a saloon car and a sports job could not possibly be confused with it. I might add, incidentally, that the sports cars of the time really appeared far more "sporty" than their counterparts today although I do not of course suggest that they were any better as far as performance went.

It is easy to follow the changes in motor car design over the years by looking through old issues of *Meccano Magazine*. The car models featured there tend to mirror the real-life vehicles in use at the time of publication and you will see that this is so from the two models described here. Both are based on models found in past issues of the M.M. and I think you will agree that both are really distinctive in design.

The first is reminiscent of the famous Morgan three-wheeler, easily recognised by the twin-cylinder motor cycle engine mounted in front of the bonnet and open to the atmosphere. The model, however, draws its power from a Magic Motor.

Construction is not difficult. Beginning as usual with the chassis, two $5\frac{1}{2}$ in. Strips 1 are joined by a

$2\frac{1}{2} \times 1\frac{1}{2}$ in. Flanged Plate 2 and a $2\frac{1}{2} \times \frac{1}{2}$ in. Double Angle Strip 3. Note that the Flanged Plate projects a distance of one hole beyond the ends of the $5\frac{1}{2}$ in. Strips. A further two $5\frac{1}{2}$ in. Strips 4 are attached to Double Angle Strip 3 by Angle Brackets and to Strips 1 by Reversed Angle Brackets 5, then a $1\frac{1}{2} \times \frac{1}{2}$ in. Double Angle Strip 6 is bolted between Strips 4, as shown. Held by Spring Clips in the rear end holes of Strips 4 is a 2 in. Rod carrying a 1 in. Fixed Pulley 7 and a centrally-mounted $2\frac{1}{2}$ in. Road Wheel.

Now bolted to Flat Plate 2 is a $2\frac{1}{2}$ in. Strip 8 to the end of which a $3\frac{1}{2}$ in. Strip 9 is fixed at right angles. A Fishplate is lock-nutted to each end of this Strip, the securing Bolt also firmly fixing a Double Bracket 10 in place, then the Fishplates are further joined by a second $3\frac{1}{2}$ in. Strip 11, lock-nutted in place. Two Angle Brackets arranged in an open-ended "V" shape are fixed to the top of Strip 11 by Bolt 12. A $1\frac{1}{2}$ in. Rod is journaled in the lugs of each Double Bracket 10 to be held in place by a Spring Clip and a $2\frac{1}{2}$ in. Road Wheel.

At this stage, the Magic Motor can be fitted, being attached to Fishplates bolted to Strips 4. Bolted to the brake lever of the Motor is a $1 \times \frac{1}{2}$ in. Double Bracket in the lugs of which a 2 in. Rod extended by a Rod Connector 13, is held by Spring Clips. The Pulley on the Motor output shaft is connected to Pulley 7 by a Driving Band.

Turning to the body, each side is similarly built up from a $5\frac{1}{2} \times 1\frac{1}{2}$ in. Flexible Plate 14 and a $2\frac{1}{2} \times 1\frac{1}{2}$ in. Flexible Plate 15, is bolted to Strip 1, a distance of one hole separating the Plates. Another $5\frac{1}{2}$ in. Strip 16 is bolted between the upper edges of the Plates then Strips 16 at each side are connected by two $2\frac{1}{2} \times \frac{1}{2}$ in.

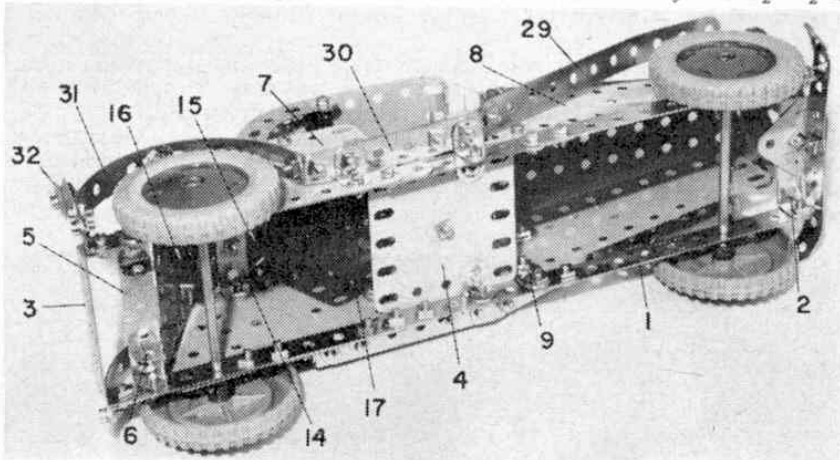

Above right: One of the most easily-recognisable sports cars of recent times was the Morgan three-wheeler, renowned for its "open-air" engine. This simple Meccano model, based on the Morgan, is powered by a Magic Clockwork Motor.

At right: For "sporty" looks, you can't beat the pre- and early post-war sports cars. This Meccano model is very reminiscent of such oldies.

Above: The simple but functional chassis of the model is clearly shown in this photograph.

At left: An underside view of the three-wheeler showing the layout of the chassis and steering gear.

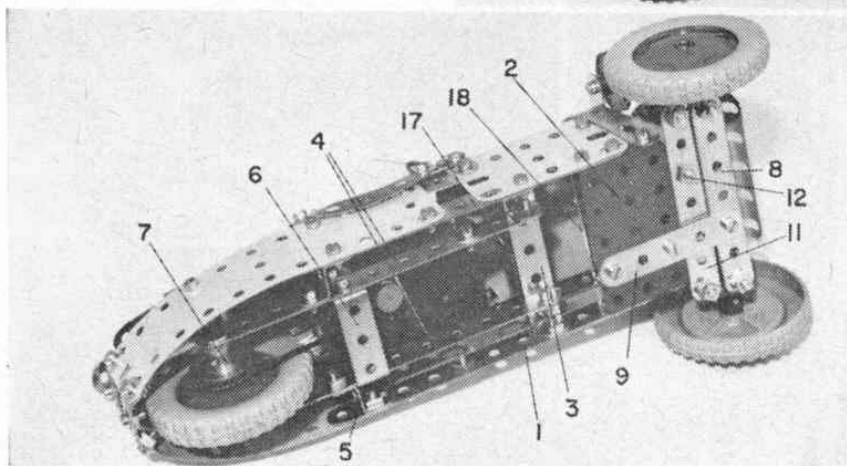

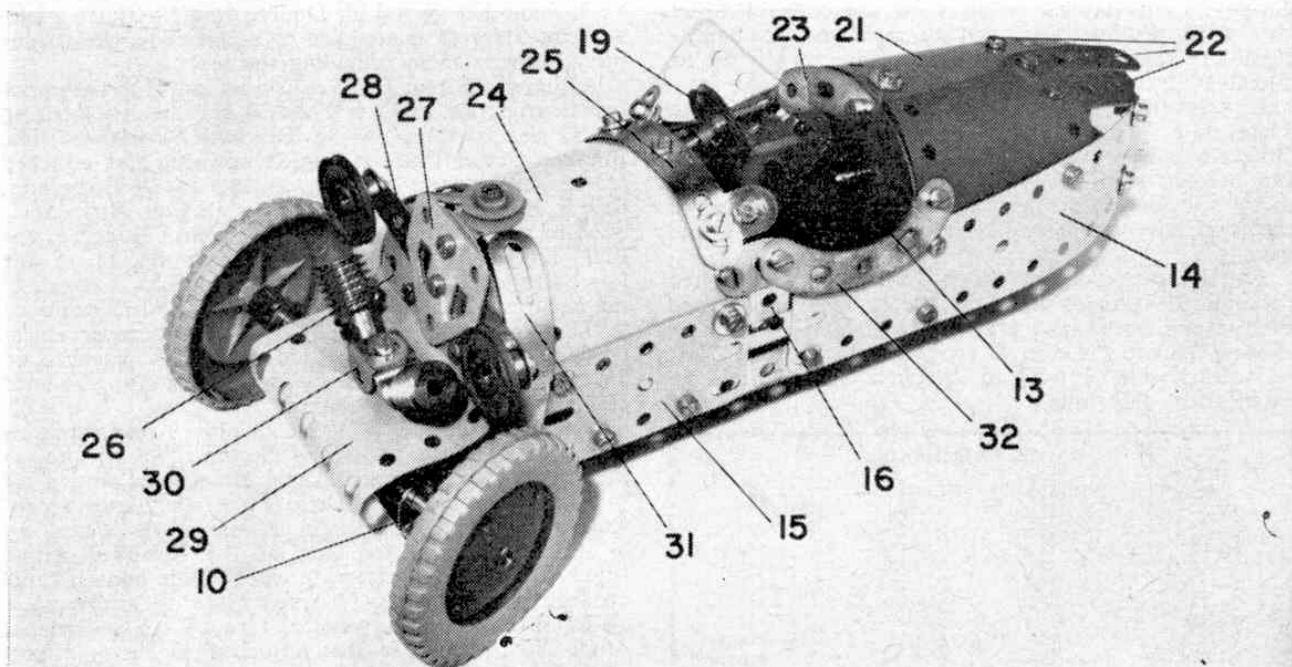

Double Angle Strips 17 and 18. A Fishplate is bolted through the second hole from the right of Double Angle Strip 17, the circular hole in the Fishplate, along with the corresponding hole in Double Angle Strip 18 providing the bearing for a $3\frac{1}{2}$ in. Crank Handle which acts as the steering column. The handle section of this Crank locates between the Angle Brackets held by Bolt 12, while a 1 in. Pulley 19 is fixed on the opposite end of the Crank Handle to serve as the steering wheel.

At the rear of the car, Plates 14 are joined by four Obtuse Angle Brackets 20 arranged in pairs, then the back is completed by a $4\frac{1}{2} \times 2\frac{1}{2}$ in. Plastic Plate 21 extended rearwards by three $2\frac{1}{2}$ in. Strips 22, positioned

as shown. A $2\frac{1}{2}$ in. Stepped Curved Strip 23 is attached to the front edge of the Plate by an Angle Bracket.

The bonnet is represented by a $4\frac{1}{2} \times 2\frac{1}{2}$ in. Flexible Plate 24 to which a Formed Slotted Strip 25 is bolted, the end securing Bolts also fixing two Obtuse Angle Brackets in place. A $2\frac{1}{2} \times 1\frac{1}{2}$ in. Transparent Plastic Plate is attached to these Brackets to serve as the windscreen. Attached to the front of Plate 24 is a $\frac{1}{2}$ in. Pulley without boss, the securing Bolt also holding an Angle Bracket to which a Semi-circular Plate 26 and a Flat Trunnion 27 are bolted, the Trunnion being spaced from the Plate by a Washer. Bolted in place between the Trunnion and the Plate are two $2\frac{1}{2}$ in.

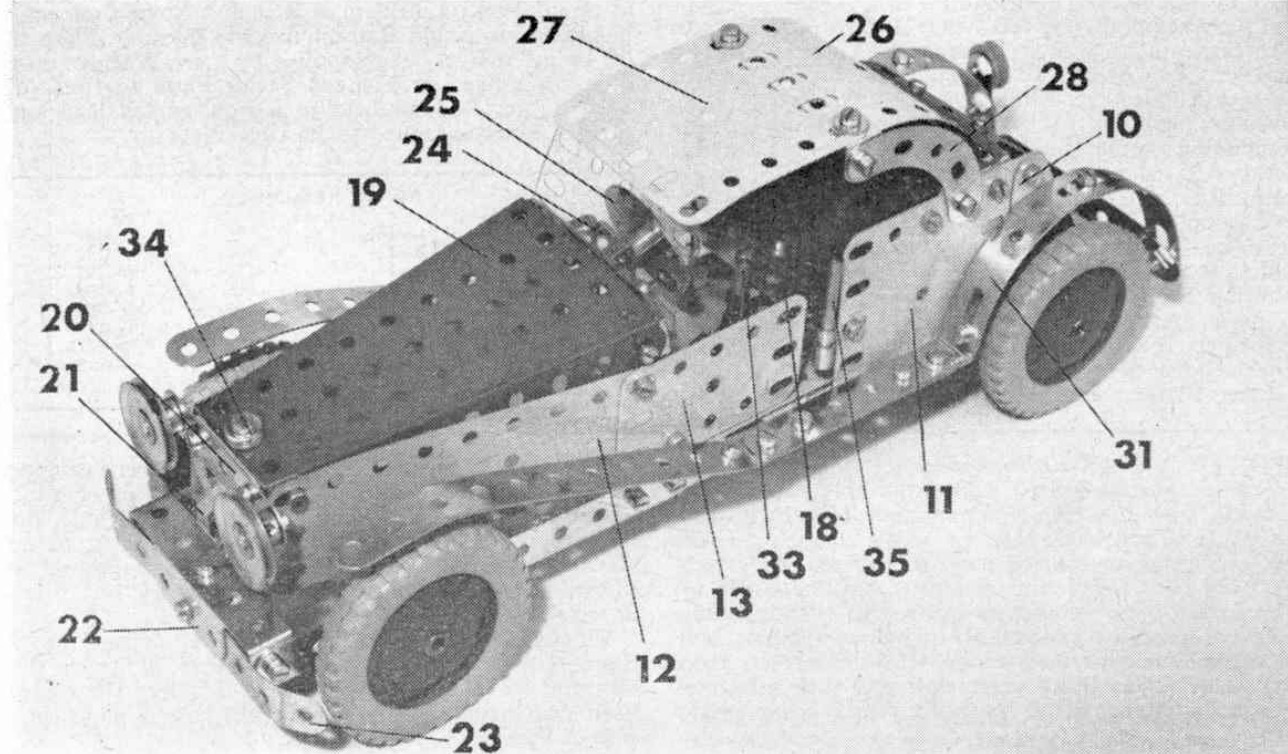

Strips 28, overlapped 3 holes, to the ends of which two 1 in. Pulleys are fixed to represent headlamps. Semi-circular Plate 26 is extended by a $2\frac{1}{2} \times 2\frac{1}{2}$ in. Flexible Plate 29, shaped as shown to cover the front axle assembly. Held by Nuts in the centre of this Plate is a $\frac{1}{2}$ in. Bolt on which two Obtuse Angle Brackets and an ordinary Angle Bracket 30 are held as can be seen in the illustration. Two Worms are fixed to the Obtuse Angle Brackets to give an indication of the distinctive engine cylinders present on the actual vehicle.

Finally, two Formed Slotted Strips 31 are bolted through the unused holes in the flanges of Flanged Plate 2 and are shaped over the front of the bonnet as shown. Plastic Plate 21 is connected to Flexible Plate 24 at each side by a $2\frac{1}{2}$ in. Stepped Curved Strip 32 extended by a Fishplate.

PARTS REQUIRED			
6-2	1-19s	1-51	2-189
2-3	2-22	3-90a	1-190
6-5	1-23	1-111a	1-191
7-10	2-32	5-111c	1-193
2-11	6-35	2-125	1-194c
1-11a	70-37a	1-126a	1-213
7-12	58-37b	1-186a	1-214
8-12c	7-38	3-187	3-215
2-17	1-48	2-188	1-Magic Motor
2-18a	3-48a		

Our second model is easily recognisable as a sports care similar to the pre- and early post-war M.G.'s. To build it, two chassis members 1 are each built up from two $5\frac{1}{2}$ in. Strips joined by a $3\frac{1}{2}$ in. Strip to result in a $12\frac{1}{2}$ in. compound strip, then the members are joined by two $2\frac{1}{2} \times \frac{1}{2}$ in. Double Angle Strips 2 and 3, a $2\frac{1}{2} \times 2\frac{1}{2}$ in. Flexible Plate 4, attached by Angle Brackets, and a $2\frac{1}{2}$ in. Strip 5 attached by Double Brackets 6. Fixed to the right-hand chassis member, in the positions shown, are a $2\frac{1}{2} \times 1\frac{1}{2}$ in. Triangular Flexible Plate, a $2\frac{1}{2} \times 2\frac{1}{2}$ in. Flexible Plate 7 and a $5\frac{1}{2} \times 1\frac{1}{2}$ in. Flexible Plate 8, the last attached at one point only by means of a Fishplate as at 9.

In the case of the left-hand chassis member, this also carries a $2\frac{1}{2} \times 1\frac{1}{2}$ in. Triangular Flexible Plate 10 and a $2\frac{1}{2} \times 2\frac{1}{2}$ in. Flexible Plate 11, but, unlike the other side, these are "butt-jointed" by a $2\frac{1}{2} \times 1\frac{1}{2}$ in. Flexible Plate. A $5\frac{1}{2} \times 1\frac{1}{2}$ in. Flexible Plate 12 corresponding with Plate 8, is included but on this occasion is extended 2 holes rearward by a second $2\frac{1}{2} \times 1\frac{1}{2}$ in. Flexible Plate 13.

The upper rear corners of Plates 7 and 11 are now connected by a $2\frac{1}{2} \times \frac{1}{2}$ in. Double Angle Strip 14 to which a $2\frac{1}{2} \times 1\frac{1}{2}$ in. Flexible Plate 15 is bolted, the securing Bolts also fixing two Obtuse Angle Brackets in place. Attached to these Obtuse Angle Brackets is a further, shaped, $2\frac{1}{2} \times 1\frac{1}{2}$ in. Flexible Plate 16 extended by a $2\frac{1}{2} \times 1\frac{1}{2}$ in. Plastic Plate. Also bolted between Plates 7 and 11 is a $2\frac{1}{2} \times 1\frac{1}{2}$ in. Flanged Plate

17 and another $2\frac{1}{2} \times \frac{1}{2}$ in. Double Angle Strip to which a $2\frac{1}{2}$ in. Strip 18 is attached by a Fishplate, these three parts between them providing the seat.

A Flanged Sector Plate 19 is now bolted to the upper front corners of Flexible Plates 8 and 12, the securing Bolts also holding Angle Brackets in place. The Flanged Sector Plate is angled upwards and attached to the rear corners of Plates 8 and 12 by Fishplates, then a Flat Trunnion overlaid by a $2\frac{1}{2}$ in. Strip 20 is fixed to the Angle Brackets at the front. Bolted to the Flat Trunnion is an ordinary Trunnion 21 to the lower flange of which a second Trunnion 22 is attached, the securing Bolt also serving to fix both Trunnions to Double Angle Strip 2. The front bumper is represented by a shaped $4\frac{1}{2}$ in. Strip 23 attached to Trunnion 22, while 1 in. Pulleys are fixed to the ends of Strip 20 to act as headlamps.

Next, another $2\frac{1}{2} \times \frac{1}{2}$ in. Double Angle Strip is bolted between the flanges of Sector Plate 19 and, to this, is fixed a Reversed Angle Bracket 24 and a $2\frac{1}{2} \times 1\frac{1}{2}$ in. Transparent Plastic Plate, the latter representing the windscreen. An 8-hole Bush Wheel 25 is attached to the free lug of the Reversed Angle Bracket to act as the steering wheel. The hood is built up from a $2\frac{1}{2} \times 2\frac{1}{2}$ in. Curved Plate 26 and a $2\frac{1}{2} \times 2\frac{1}{2}$ in. Flexible Plate 27 bolted to a $2\frac{1}{2} \times \frac{1}{2}$ in. Double Angle Strip which is then attached to Plates 7 and 11 by $2\frac{1}{2}$ in. Stepped Curved Strips 28.

Two sets of combined mudguards and running board are each produced from a $5\frac{1}{2}$ in. Strip 29 attached by an Obtuse Angle Bracket to a 3 in. compound strip 30, obtained from two $2\frac{1}{2}$ in. Strips which is in turn attached by an Angle Bracket to two Formed Slotted Strips 31. The whole thing is attached to the appropriate chassis member by Angle Brackets. The wheels themselves are $2\frac{1}{2}$ in. Road Wheels fixed on $3\frac{1}{2}$ in. Rods journaled in the chassis members.

The model is completed by the addition of (a) a rear light, represented by a $\frac{1}{2}$ in. Pulley 32, attached by an Obtuse Angle Bracket to the right-hand rear mudguard; (b) by an imitation gear lever supplied by a $1\frac{1}{2}$ in. Rod 33 held in a Rod and Strip Connector bolted to an Angle Bracket fixed to Flexible Plate 7; (c) by a "mascot" 34 supplied by three Washers on a $\frac{3}{8}$ in. Bolt fixed in Flanged Sector Plate 19; and (d) by a $1\frac{1}{2}$ in. Rod 35 held in a right-angled Rod and Strip Connector bolted to Flexible Plate 11.

PARTS REQUIRED			
6-2	1-18b	1-54	2-189
2-3	2-22	2-90a	4-190
9-5	1-23	5-111c	1-193
5-10	1-24	1-125	1-194
2-11	82-37a	2-126	1-200
12-12	80-37b	1-126a	1-212
5-12c	6-38	4-187	1-212a
4-16	6-48a	4-188	4-215
1-18a	1-51		

BATTLE (continued from page 642)

an enemy rumbling into sight, was able to draw an immediate bead on him and slam a shell forthwith into his vitals. Tank battles *did* go on for longish periods, and our desire to achieve some sort of realism closely coincides with the desire to ensure that the battle we are engaged in is not over in a matter of a few minutes.

It will be seen that some of the lighter weapons have no strike value at long range—this is correct, their muzzle velocities being pretty low and their effectiveness at anything above medium range being pretty feeble.

The range of some of the most powerful guns extends as we have already seen up to the equivalent of 2000 yards, or 60 in. This is not included in the Table, for the simple reason that visibility will be found to be rarely sufficient for efficient firing at this range to be carried out, particularly where the country is 'close' or wooded and hilly.

Finally, the result of the shot did depend on a couple of obvious conditions—whether it struck the target at which it was aimed, and if indeed the target itself was visible. These points will be our main concern in Part IX.

AMONG THE MODEL BUILDERS

with "SPANNER"

IN THIS article it is customary to steer clear of complete models and deal more with mechanisms, hints, suggestions and matters of general interest to modellers. I have long thought, however, that life would be pretty dull if everyone always followed custom implicitly, without breaking away from "the usual", at least on odd occasions, and so this month I make no apologies for featuring in full the delightful little "simplicity" model illustrated here. Vaguely reminiscent of the old Morgan 3-wheeler, it was sent to me by Roger Le Rolland of Stoke-on-Trent, whose Steam Carriage is described elsewhere in this issue, and it appealed to me immediately. These tiny little models, built with the smallest possible number of parts, always do, you know!

It consists of a Sleeve Piece 1, in each end of which a Chimney Adaptor is fixed by Nuts on a 1 in. Screwed Rod, each Adaptor first having bolted to it a Fishplate

Below: A delightful little "simplicity" model, reminiscent of the old Morgan 3-wheeler, designed by Roger Le Rolland of Stoke-on-Trent.

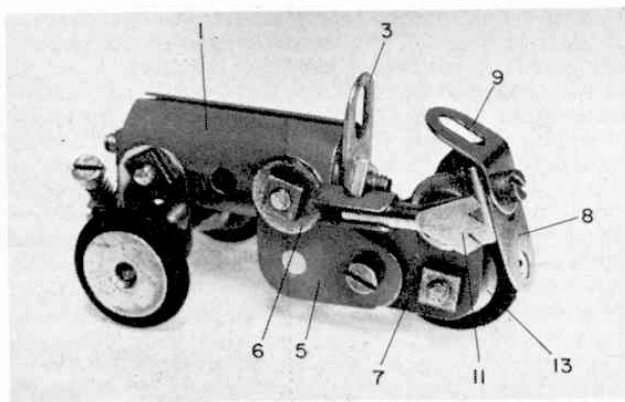

2 or 3, as the case might be. Note that the front Fishplate 2 points vertically downwards, while that at the rear points vertically upwards to represent the windscreen.

Held by the Nuts fixing the front Adaptor to the Sleeve Piece are two more Fishplates 4, whereas the Nuts fixing the rear Adaptor hold two 1 in. Corner Brackets 5, the left-hand Nut also holding a Rod and Strip Connector 6 in place. Bolted to each Corner Bracket 5, but spaced from it by a Washer on the shank of the securing Bolt, is another 1 in. Corner Bracket 7, these Brackets at each side being joined through their upper holes by a Double Bracket, to the back of which a Fishplate 8 and an Obtuse Angle Bracket 9 are bolted.

Now fixed to the lower end of Fishplate 2 is the

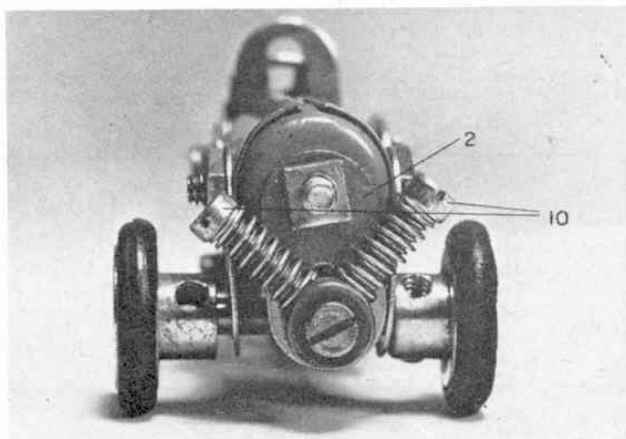

"spider" from a Universal Coupling, in adjacent holes of which are screwed two $\frac{1}{2}$ in. Bolts 10, each carrying a Compression Spring on its shank. These Bolts, with their Springs, represent the engine cylinders, an exhaust pipe subsequently being represented by a Centre Fork 11, held in Rod and Strip Connector 6.

Finally, the wheels are fitted, those at the front consisting of $\frac{1}{2}$ in. Pulleys with boss 12, mounted on a $1\frac{1}{2}$ in. Rod journalled in the free holes of Fishplates 4, while the single rear wheel is a $\frac{1}{2}$ in. Pulley without boss 13 mounted, along with three spacing Washers, on a Threaded Pin fixed in left-hand Corner Bracket 7. If available, suitable Dinky Toy tyres should be fitted to all the Pulleys to improve realism.

Above: The famous V-2 motor cycle engine at the front of the car is realistically represented by Compression Springs mounted on Bolts. The tyres are off an old Dinky Toy.

Below: An underside view of the 3-wheeler showing the wheel arrangement. Note the use of a Threaded Pin for the rear axle.

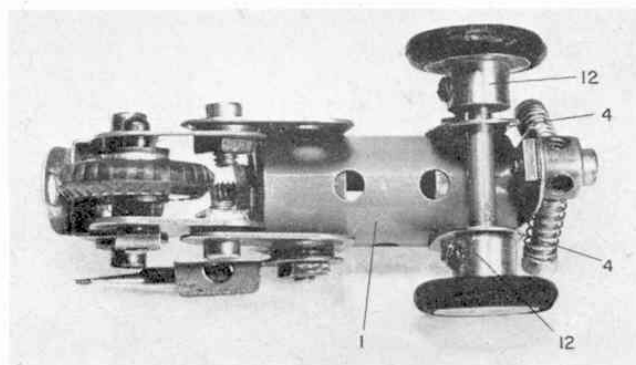

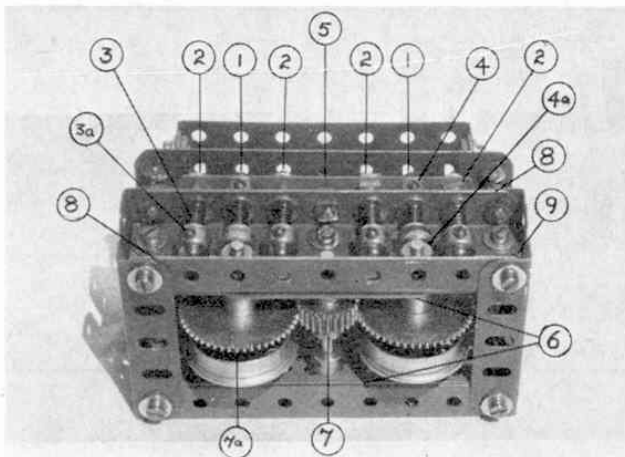

A heavy-duty Crane Bogie designed by Swiss reader Ulysse Bachelard of Zurich. It is best used as one of a pair under operating conditions.

PARTS REQUIRED

5—10	2—23d	2—82	1—140y
1—11	13—37a	2—111a	1—163
1—12c	7—37b	1—111c	2—164
1—18a	5—38	2—120b	1—212
1—23	1—65	4—133a	3—Dinky Toy Tyres

Crane Bogies

Returning, now, to true mechanisms, we have a couple of extremely interesting items which advanced crane-builders will find invaluable—a pair of heavy-duty crane bogies designed by Ulysse Bachelard of Zurich, Switzerland. The units are first class and a credit to Mr. Bachelard's skill, but, as Mr. Bachelard cannot speak English, my thanks also go to Bert Love, Secretary of the Midlands Meccano Guild, for supplying me with the following descriptions of the bogies as well as the accompanying photographs.

Both bogies are fully sprung with helical springs and they exploit to very good advantage the elongated holes which are found in Angle Girders and Flat Girders. This principle has been utilised in previous Meccano mechanisms, of course, but their combination with helical or coil springs is somewhat unique. The first mechanism is a two-wheeled unit, which is best used as one of a pair, joined by a sturdy cross member at the

Another heavy-duty Crane Bogie from Mr. Ulysse Bachelard, this one longer, but considerably narrower than the first example.

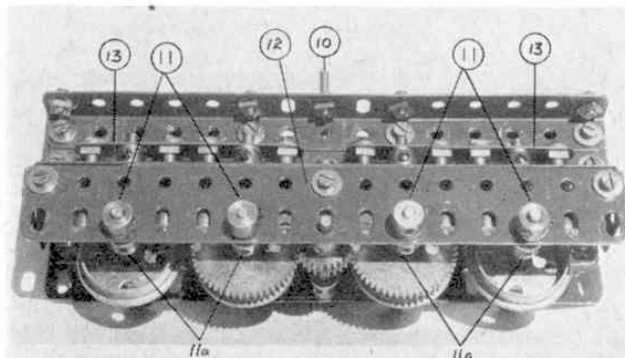

base of a dockside crane. General construction is apparent from the illustration and consists of $4\frac{1}{2}$ in. Angle Girders for the framework, these being cross-joined by $2\frac{1}{2}$ in. Angle Girders. The essential feature of this type of suspension lies in the equalising beams which consist of $3\frac{1}{2}$ in. Narrow Strips 5, which are mounted on both sides of the bogie and which carry four Long Threaded Pins 2, lock-nutted to the Narrow Strips. Each Threaded Pin passes down through the top of the upper Angle Girder 8 and is then fitted with a Compression Spring 3 sandwiched between two Washers, which are held in place by a Collar 3a at the end of each Axle Threaded Pin. Both driven Gears, carried on $2\frac{1}{2}$ in. Axle Rods, mesh with a $\frac{3}{4}$ in. Pinion 7 which, in turn, is driven by a $\frac{3}{4}$ in. Contrate Wheel mounted on a vertical shaft, not shown. Each of the two 50-teeth Gears 7a, together with its associated Flanged Wheel, serves to hold its Rod in place, the external Collars 4a being loose, as they form pivot bearings for the last section of the suspension. Each Narrow Strip 5 receives two more Threaded Pins 1 which are screwed into the floating Collars 4a at the end of the Axle Rods. Again, each Threaded Pin carries a Compression Spring sandwiched between two Washers, but, in this case, each Threaded Pin is spaced with two Washers before being screwed into the Floating Collars 4a to prevent the axles from binding. The upper ends of Threaded Pins 1 carry thrust Collars 4 which bear against Narrow Strip 5, being spaced from it by one Washer.

Construction of the lower parts of the bogie is very important since it relies upon accurate location of slotted holes in a pair of $4\frac{1}{2}$ in. Flat Girders 9, bolted at each side of the bogie frame to a pair of $4\frac{1}{2}$ in. Angle Girders 8. It is important to make sure that all elongations match up exactly so that the two Axle Rods carrying the Flanged Wheels may ride vertically under load. To maintain constant mesh between the Driving Pinion 7 and the two 50-teeth Gear Wheels, 7a, they are linked via a pair of $2\frac{1}{2}$ in. Perforated Strips 6 which are also free to ride up and down the movement of the suspension. The upper portion of the bogie is reinforced by further $4\frac{1}{2}$ in. Angle Girders, joined by $2\frac{1}{2}$ in. Angle Girders, while a $3\frac{1}{2} \times 2\frac{1}{2}$ in. Flanged Plate forms the top of the central drive shaft. This drive shaft, which carries a $\frac{3}{4}$ in. Contrate Wheel, is also provided with a Compression Spring to keep the Contrate in constant mesh with Pinion 7 under all suspension conditions. In each case, the Compression Springs may be "doubled up" for additional load carrying.

In the case of the second bogie, the overall width has been reduced to $1\frac{1}{2}$ in. from the first unit's $2\frac{1}{2}$ in. width, but the equalising beams are doubled, being supplied by two 3 in. Narrow Strips, 13, in which the arrangement of Long Threaded Pins can be clearly seen. All suspension units are mounted internally and location of the Flanged Wheels and Gear Wheels are obtained by external Collars 11. The internal Collars 11a on each Axle Rod form the floating bearings as employed in the smaller unit.

In the accompanying illustration, the floating action provided by the elongated holes in the $7\frac{1}{2}$ in. Flat Girders is evident and, again, the gearing at the centre—which drives the inner two wheels only—is linked by a pair of $2\frac{1}{2}$ in. Perforated Strips. The Drive Shaft 10 is also mounted vertically as before, and passes on the travelling motion via a $\frac{3}{4}$ in. Contrate Wheel to the $\frac{3}{4}$ in. Pinion in the centre.

Either of Mr. Bachelard's travelling bogies is suitable for many of the wide variety of dockside cranes or other



This year is the fiftieth anniversary of the Morgan Motor Company, perhaps the most remarkable British motor car producers still in business as a private concern

NINETEEN-SEVENTY marks the Diamond Jubilee of one of the few surviving family businesses in the motor industry—The Morgan Motor Company of Pickersleigh Road, Malvern Link. The Morgan story really goes back beyond the formation of the company—to 1881, in fact, when Mr. H. F. S. Morgan was

born at Stoke Lacy Rectory in Hereford. “HFS”, as he became widely known, was the son of the late Rev. Prebendary H. G. Morgan, and was educated at Stone House, Broadstairs; Marlborough College and the Crystal Palace Engineering College. At 18, he began his career at the G.W.R. Railway Works in Swindon,



Left: Two Morgan 3-wheelers in the recent concours at Prescott: FF2720 dates from 1928 and JO9778 is a model from the 30's.

Above: Line-up of Morgan 4-wheelers ranging from 1936 to 1970 recently seen at Prescott.



A 1928 Super-Aero Matchless Morgan 3-wheeler in action at a Prescott Hill climb recently.

eventually becoming a draughtsman to spend seven years in the drawing office.

During this time, HFS was developing a love of motor cars and in 1899 he hired a 3½ h.p. Benz cycle-car from a Mr. Marriot, Hereford's first motor trader. This first drive nearly ended in disaster when the car ran away with him down a 1-in-6 gradient, coming to an abrupt stop at the bottom. HFS was unhurt, but his father had to foot a repair bill of £28. Following this ill-fated event, HFS saved hard for three years to purchase his own machine—an Eagle Tandem. This was an 8 h.p. three-wheeler and helped to give its owner the idea of building his own three-wheeler car.

In 1906, at the age of 25, HFS left the G.W.R. and opened a garage and motor works in Malvern Link, where he carried out experimental work and also ran a very successful Bus Service between Malvern Link and Malvern Wells. He was using 10 h.p. Wolseley 15-seaters for this service, and was later to run additional services between Malvern and Gloucester. During this period, he designed a three-wheeled tubular chassis and installed in it a 7 h.p. Twin Peugeot engine that he originally bought for a motor cycle. This experiment was to prove the beginning of forty years of three-wheeler production, but at the time there had been no intention of marketing the vehicle. This model, which was called the Morgan Runabout, received such favourable comment wherever it went that the decision was made to build a few for sale. Hence, in 1910, with capital for machine tools and an extension to the garage provided by his father, HFS

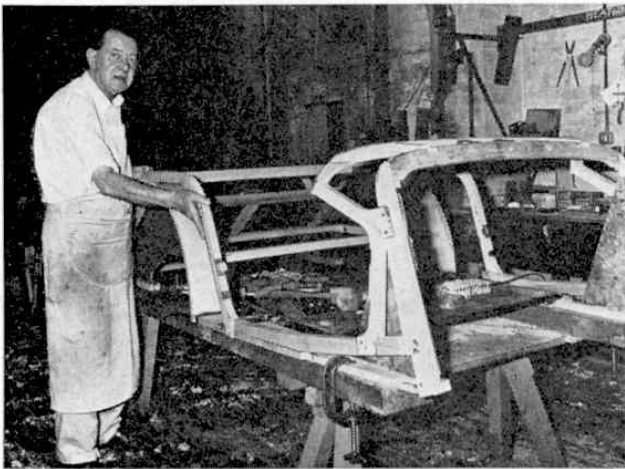

The ash framework of a Morgan 4/4 body is hand built.

started production. With Patent drawings provided by a bright youth by the name of John Black (later to become the famous Sir John Black of the Standard Motor Company) a Patent was granted, and the first Morgans appeared at the Olympia Motor Show in 1910. These were single seaters and created great interest, securing about thirty orders. However, it was clear that the public would prefer two-seaters and these were produced in time for the 1911 Motor Show.

Meanwhile, HFS entered his single-seater, three-wheeler in the London-Exeter-London reliability trial, winning the highest possible award—a Gold Medal. The orders poured in and the garage was further equipped and extended with the help of deposits received on orders. In 1912, the Morgan Motor Company was formed as a private Limited Company, with the Rev. H. G. Morgan as Chairman and his son Managing Director. From now on Morgans were to really make their name in Motor Racing circles with many class wins at Brooklands as well as in Reliability and Speed trials. In 1913, a Morgan made the fastest time at the Midland Automobile Club's Shelsley Walsh Hill-climb, near Worcester, with a speed of 22 m.p.h. (The record today stands at more than 60 m.p.h.).

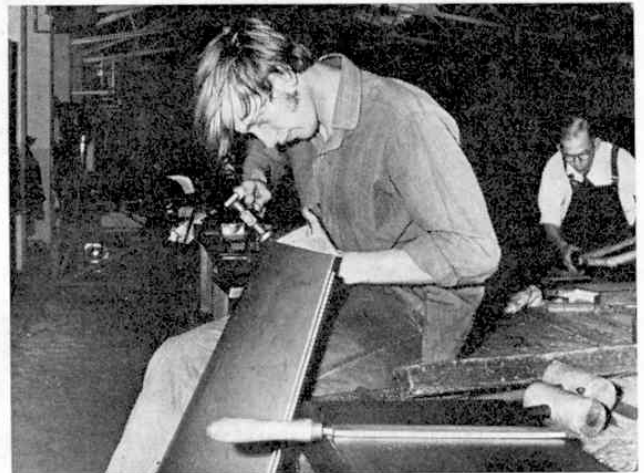

Shaping the bonnet of a Morgan is done by hand. A highly skilled and time consuming task.

Production came to a virtual stand-still during the first World War as the factory was chiefly concerned with munitions, but soon after the war demand was so great for inexpensive transport that the output rose to 50 cars per week. In 1925, Mr. George Goodall joined the company to take over the position of General Manager from Mr. A. Hales, who had been with HFS since 1911. George retired from this position in 1958, and his son, Mr. W. A. G. Goodall is now Works Manager. The three-wheelers continued to win award after award, with 1933 bringing a large number of world records. The original design had been so advanced that few basic alterations were made over the years, apart from the variety of different engines that were tried, and the addition of refinements such as electric-starters and front-wheel brakes.

In 1936, the first 4-wheeler was built and was exhibited at the London and Paris Exhibitions. This new model was called the 4/4, indicating a 4-cylinder engine and four wheels. 1937 saw the death of the Rev. H. G. Morgan and HFS became Chairman and Governing Director. (He was to die at the age of 77 on June 15th, 1959, to be succeeded by his son, Mr.

P. H. G. Morgan, present Governing and Managing Director.) Various models of the Morgan 4/4 were quickly produced for touring or racing, using such power units as a 1098 c.c. Coventry Climax engine developing 42 b.h.p. (one such model met with great success at Le Mans in 1938), or a modified 9 h.p. Standard engine. The latter was used in conjunction with a Moss gear-box, similar to those still being installed in current models.

The Second World War again caused a standstill in car manufacture in Malvern and the factory was turning out parts for the Oerlikon anti-aircraft gun, aircraft components and other precision work. In 1947, Mr. P. H. G. (Peter) Morgan joined the firm as Development Engineer and Draughtsman after his demobilisation. He had spent three years at the Chelsea Engineering College before the war and had himself successfully competed with his father in the 1939 RAC Rally. The long and difficult transition back from munitions to car manufacture was overcome and in 1950 the reluctant decision was made to cease production of the three-wheelers (to the chagrin of members of the thriving Morgan Three-wheeler Club!). This decision was due to the export demand for the four-wheelers in favour of their smaller counterparts.

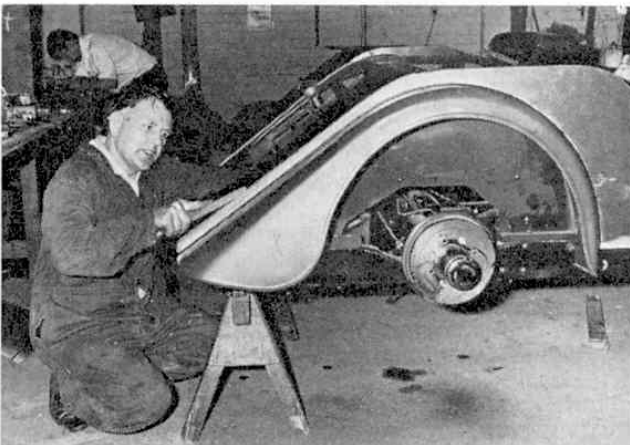

Hand finishing the boot and rear wings of a Morgan 4/4.

Nineteen-fifty-four saw styling changes to the bodywork to introduce the familiar Morgan shape still produced today. The fifties and sixties saw various members of the Morgan family and many others hurtling around circuits and over appalling trials courses in versions of the 4/4 with tremendous success both in this country and in the U.S.A.

In 1968, what must be the ultimate in "hairy" sports cars was introduced when a 3½ litre Rover V-8 engine was squeezed into the 4/4 to produce a model known as the Plus 8. With a claimed top speed of 132 m.p.h. and acceleration which can dislocate the spine, this car is a real enthusiast's dream. Mr. Peter Morgan took me for a run around the Malvern lanes in his personal Plus 8 and the experience was, to say the least, memorable! One point that impressed me was the lack of hair-tearing slip-stream so often experienced in open sports cars. I can only assume that the driving position in the Morgan, close to the shallow windscreen, coupled with the shape of the enormously long bonnet, directs the howling gale over the driver's head. The Morgan is not built for comfort and the suspension is intentionally hard for competition driving, but I did not suffer any undue bone-jarring along the none-too-smooth Worcestershire lanes.



Rubbing down the bodywork of a Morgan 4/4 before spraying.

Today the Morgan Motor Company, with a staff of about a hundred, produces ten cars a week. There is a waiting list of eight months for them, which means an order book of some 330 Plus 8 or the more docile 4/4 models. The Company is reluctant to expand because one of the reasons for the popularity of the Morgan is its scarcity and exclusiveness. Such names as Brigitte Bardot and Jeremy Nabarro appear on the list of owners, as do Mr. Peter Morgan's son, Charles, and two sons-in-law, Lord Colwyn and Dr. Price.

Recently, as part of the 60th Anniversary celebrations, the Morgan 4/4 and Three-wheeler Clubs were invited to take part in a Prescott Hill-climb meeting by the Bugatti and Ferrari Owners' Clubs. Nearly 300 brightly coloured 3 and 4 wheelers, dating from as far back as 1921, arrived to take part in glorious sunshine in the Hill-climb proper as well as a Morgan Cavalcade and Concours. The latter was judged by Mr. Peter Morgan, who was delighted by the turnout.

The Morgan has always been a car designed by enthusiasts, and built, tried and tested by enthusiasts for sale to enthusiasts. I am sure that Mr. Peter Morgan builds his cars because he loves to drive and compete in them. His father is reported to have said "Looking back through the years, seeing both errors and triumphs in their correct perspective, I feel I have enjoyed it all. The motor trade has been, as far as I am concerned, a most interesting business."



Mr. Peter Morgan with his personal Morgan plus-8.

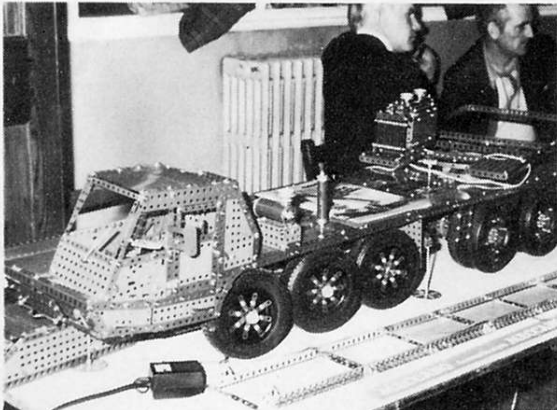

Large-scale modeller Raymond Stephens presented this 6 feet long Grove 1150 Crane Carrier finished in red and green parts, three axles were powered by one motor.

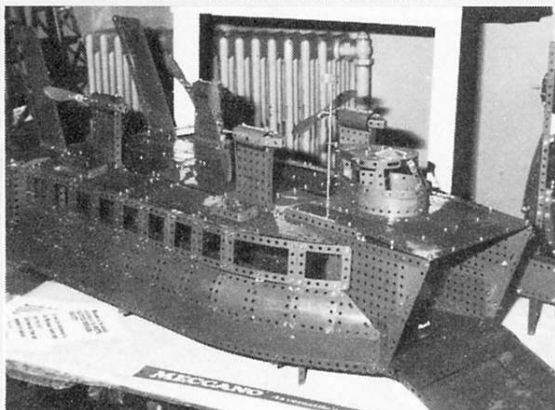

Revolving radar dish, propellers and an opening door are just a few of the features incorporated in Frank Beadle's SRN6 Hovercraft.

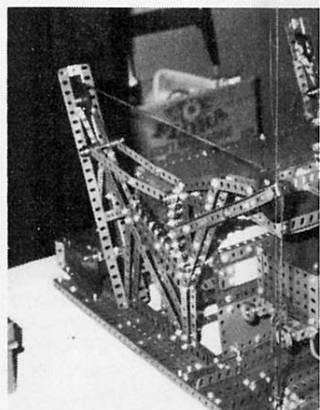

Bill Butterfield showed this fine version of a Tipping Device, incorporating all the counterpart.

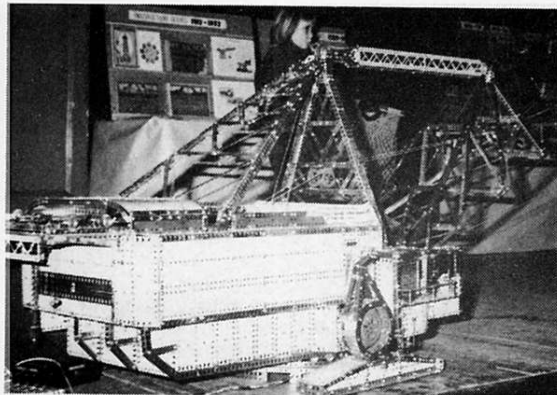

The largest model in the show was undoubtedly Joe Etheridge's 12 feet long Ransomes & Rapier W1400 Dragline Excavator. Weighing 125 kg, no fewer than eleven motors powered its many movements.

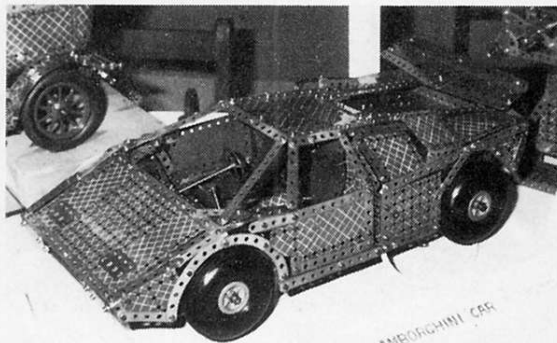

The Blue/Gold criss-cross plating of a bygone era makes a distinctive cladding for Frank Beadle's Lamborghini sports car.

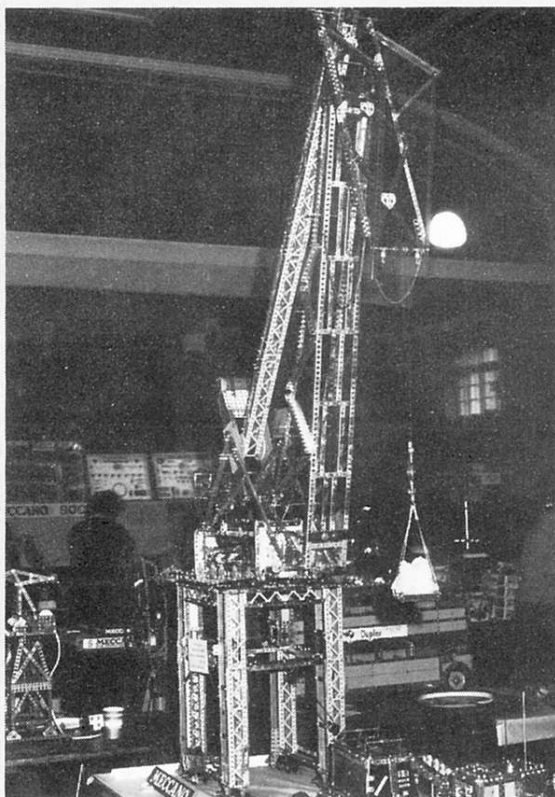

This six feet high level luffing Crane was the remarkable work of 12 year old Robert Anderson and was augmented by a superb heavy duty Recovery Truck with extending jib, front winch, suspension and a 2-speed gearbox.

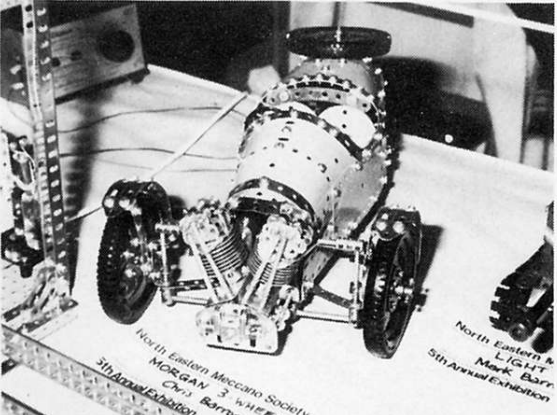

Chris Barron built this extremely neat model of a Morgan three-wheeler car with engine detail and driven by a PDU.

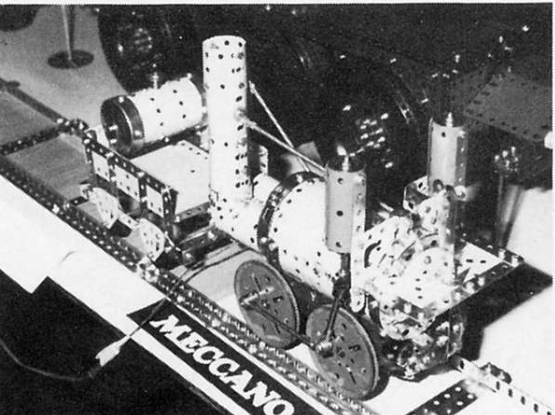

Traversing along a six feet length of track, the 'Sans Pareil', built to a scale of 1:13.5 by Ron Barnby.

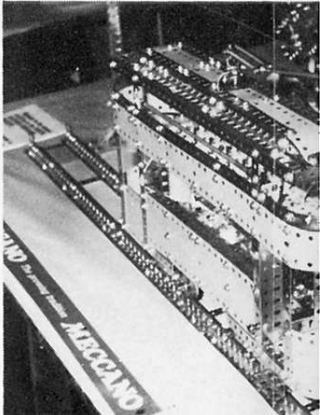

A working Tramcar by Chris Barron, featuring a realistic trolley pole mechanism.

Scene at Darling 198

A look at just a few excellent models of North Eastern Meccano Annual Meccano Exhibition in Darlington on No