

# New Meccano Models

## Beam Engine—Fret-Machine

**C**ONSTRUCTION of the model Beam Engine shown in Figs. 1 and 2 is begun by building up two rectangles from  $18\frac{1}{2}$ " and  $7\frac{1}{2}$ " Angle Girders. For these the ends of two  $18\frac{1}{2}$ " Girders are bridged by two  $7\frac{1}{2}$ " Girders, the four being securely bolted together. When the two rectangles are built they are connected together by four  $5\frac{1}{2}$ " Angle Girders 1 placed one at each corner as shown in Fig. 1. Two further  $5\frac{1}{2}$ " Angle Girders 2, Fig. 2, serve as supports for a  $5\frac{1}{2}$ "  $\times$   $3\frac{1}{2}$ " Flat Plate that forms a base for the governor mechanism. The beams are carried on supports consisting of four  $18\frac{1}{2}$ " Angle Girders, which are bolted two on each side of the base as shown, and at their upper ends are bolted to 4" Circular Plates. These Plates each carry a Bush Wheel in which the axle on which the beams pivot is journalled. The construction of the beams will be clear from Fig. 1. The Rod on which the beams pivot is passed through the centre holes of two  $4\frac{1}{2}$ " Angle Girders, which form the centre vertical member of the beams. The  $9\frac{1}{2}$ " Strips of the beams are bolted to the ends of these Girders.

The cylinders are Meccano Boilers, complete with Ends, which are secured to a  $5\frac{1}{2}$ "  $\times$   $3\frac{1}{2}$ " Flat Plate, 3 bolted between the lower  $18\frac{1}{2}$ " Angle Girders of the base.

The crankshaft webs are formed by four  $2\frac{1}{2}$ " Triangular Plates 4 and 5, to each of which two Cranks are bolted as shown with their bosses facing in opposite directions. The crankshaft carries between the two cranks a Sprocket Wheel that takes the drive from an Electric Motor, which may be bolted in any convenient position inside the base of the model. On the left-hand end of the crankshaft there is another Sprocket, connected by Chain to a Sprocket on the shaft of the governor. The connecting rods 7 and 8 are coupled to the crank pins at their lower ends by means of Handrail Couplings, one of which is shown

at 9; and connection to the beams is made by means of further Handrail Couplings at their upper ends. The Handrail Couplings pivot on 1" Rods held in place in the ends of the beams by Collars.

The opposite ends of the beams also carry 1" Rods on each of which pivot two pairs of  $9\frac{1}{2}$ " Strips 10 and 11, Fig. 1, which form the links between the beams and the piston rods 12 and 13. Connection between the Strips and the Rods is made by means of large Fork Pieces.

The flywheel 14 consists of two Ring Frames, bolted back to back and fitted

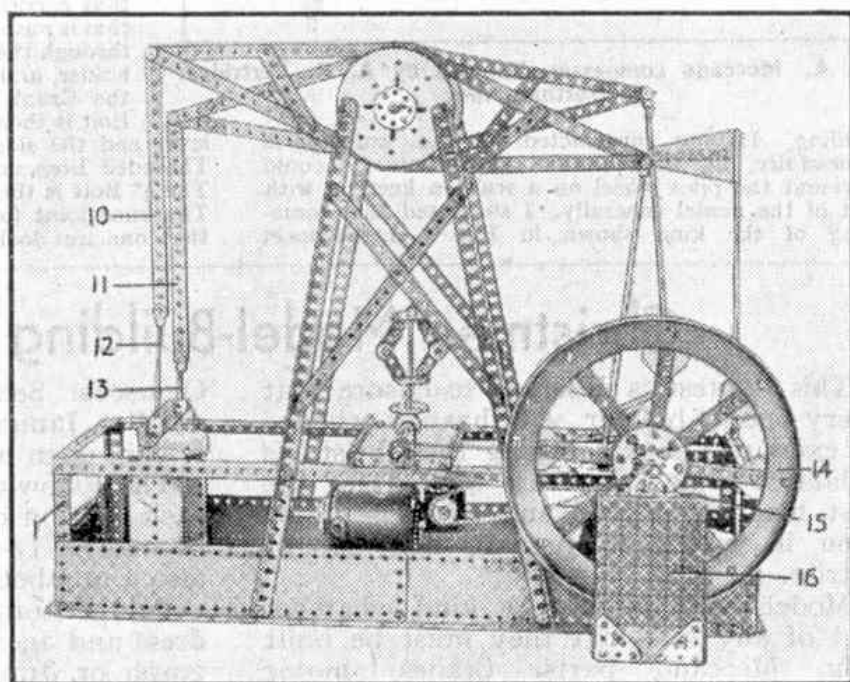

Fig. 1. A fine working model Twin Beam Engine.

with spokes consisting of  $4\frac{1}{2}$ " Strips. The hub of the wheel is a Face Plate.

The crankshaft is journalled in Trunnions fixed to the frame in the positions shown in Fig. 2, and at the flywheel end there is an outrigger bearing consisting of a further Trunnion bolted to a  $3\frac{1}{2}$ " Angle Girder 15. This Girder is supported between the ends of two  $5\frac{1}{2}$ " Angle Girders that in turn are attached at their lower ends to the  $12\frac{1}{2}$ " Angle Girders of the base by means of two  $3\frac{1}{2}$ " Angle Girders. The  $5\frac{1}{2}$ " Girders are also joined at their lower ends by a second  $3\frac{1}{2}$ " Angle Girder, and the rectangular frame so formed is filled in with a  $5\frac{1}{2}$ "  $\times$   $3\frac{1}{2}$ " Flat Plate 16.

The construction of the governor is

shown clearly in the illustrations. Its shaft is journaled in the Flat Plate and also in a Double Bent Strip 17 bolted to the Plate; and a  $1\frac{1}{2}$ " diam. Contrate fixed to it is meshed with a 1" Gear carried on a Rod journaled in a  $2\frac{1}{2}$ " x 1" Double Angle Strip bolted to the Plate.

Parts required to build model Beam Engine: 24 of No. 1a; 8 of No. 2a; 8 of No. 3; 4 of No. 6a; 8 of No. 7a; 16 of No. 9; 4 of No. 9a; 4 of No. 9b; 6 of No. 12; 3 of No. 13a; 1 of No. 14; 3 of No. 15; 1 of No. 15b; 1 of No. 16; 2 of No. 18a; 6 of No. 18b; 4 of No. 23; 4 of No. 24; 1 of No. 28; 1 of No. 31; 174 of No. 37; 10 of No. 37a; 3 of No. 45; 1 of No. 46; 3 of No. 52a; 21 of No. 59; 8 of No. 62; 2 of No. 95; 1 of No. 96; 1 of No. 109; 2 of No. 111; 2 of No. 116; 4 of No. 126; 8 of No. 126a; 4 of No. 133; 4 of No. 136a; 2 of No. 146a; 2 of No. 162; 2 of No. 167b; 2 of No. 190; 2 of No. 192; 4 of No. 197, 1 Electric Motor.

The simple and attractive model of a fret-machine shown in Fig. 3 can be worked either by hand or by a *Magic Motor*.

The table of the machine is built from four  $5\frac{1}{2}$ " Strips and a  $4\frac{1}{2}$ " Flanged Sector Plate and braced by two  $5\frac{1}{2}$ " Strips, as shown in the illustration. The reciprocating arm consists of two  $5\frac{1}{2}$ " Strips, one above the table and the other underneath it, joined together by two  $2\frac{1}{2}$ " Strips 1 bolted to the  $5\frac{1}{2}$ " Strips in the manner illustrated.

The arm is pivoted on a lock-nutted bolt through the holes of two Reversed Angle Brackets, which are spaced from the  $1\frac{1}{2}$ " x  $\frac{1}{2}$ " Double Angle Strip 2 by two Washers, and also through the centre holes of the  $2\frac{1}{2}$ " Strips 1.

The bracing of the table legs carries a  $3\frac{1}{2}$ " Crank Handle. On this is a cam built by bolting two Flat Brackets spaced by a Washer on each

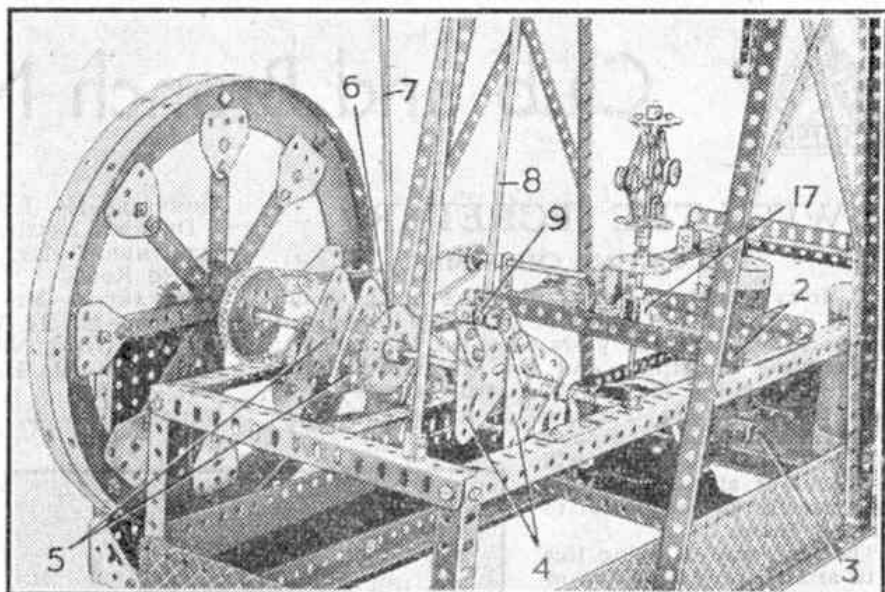

Fig. 2. A close-up view of the Beam Engine showing details of the crankshaft and governor.

side of a Bush Wheel, together with a Road Wheel and a 1" fixed Pulley. The positions of these will be clear from the illustration. A piece of wire is stretched from the end hole of the upper  $5\frac{1}{2}$ " Strip to that of the  $5\frac{1}{2}$ " Strip under the table, and passes through the appropriate hole in a  $4\frac{1}{2}$ " Flanged Sector Plate. This represents the saw blade.

A quick return stroke is effected by doubling a small Driving Band 3 over the arm and looping it on to a Cranked Bent Strip 4, through which the  $1\frac{1}{2}$ " Rod 5 is pushed. If desired, the *Magic Motor* can be bolted to the front leg of the fret-machine and the Driving Band fitted around the 1" Pulley. If a Motor is used, it is advisable to strengthen the front legs by connecting them together with a Double Angle Strip bolted near their lower ends.

Parts required to build Fret-machine: 8 of No. 2; 2 of No. 5; 4 of No. 10; 2 of No. 12; 1 of No. 17; 1 of No. 17a; 1 of No. 19s; 1 of No. 22; 1 of No. 24; 2 of No. 35; 21 of No. 37; 1 of No. 37a; 8 of No. 38; 1 of No. 44; 1 of No. 48; 1 of No. 54a; 1 of No. 111c; 2 of No. 125; 2 of No. 180; 1 of No. 187.

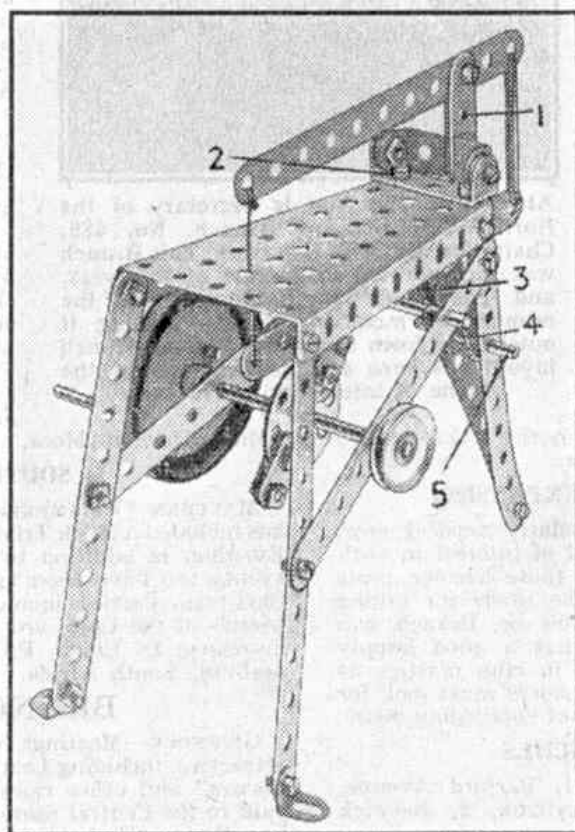

Fig. 3. A simple fret-machine that operates realistically.



shown clearly in the illustrations. Its shaft is journaled in the Flat Plate and also in a Double Bent Strip 17 bolted to the Plate; and a  $1\frac{1}{2}$ " diam. Contrate fixed to it is meshed with a 1" Gear carried on a Rod journaled in a  $2\frac{1}{2}$ " x 1" Double Angle Strip bolted to the Plate.

Parts required to build model Beam Engine: 24 of No. 1a; 8 of No. 2a; 8 of No. 3; 4 of No. 6a; 8 of No. 7a; 16 of No. 9; 4 of No. 9a; 4 of No. 9b; 6 of No. 12; 3 of No. 13a; 1 of No. 14; 3 of No. 15; 1 of No. 15b; 1 of No. 16; 2 of No. 18a; 6 of No. 18b; 4 of No. 23; 4 of No. 24; 1 of No. 28; 1 of No. 31; 174 of No. 37; 10 of No. 37a; 3 of No. 45; 1 of No. 46; 3 of No. 52a; 21 of No. 59; 8 of No. 62; 2 of No. 95; 1 of No. 96; 1 of No. 109; 2 of No. 111; 2 of No. 116; 4 of No. 126; 8 of No. 126a; 4 of No. 133; 4 of No. 136a; 2 of No. 146a; 2 of No. 162; 2 of No. 167b; 2 of No. 190; 2 of No. 192; 4 of No. 197, 1 Electric Motor.

The simple and attractive model of a fret-machine shown in Fig. 3 can be worked either by hand or by a *Magic Motor*.

The table of the machine is built from four  $5\frac{1}{2}$ " Strips and a  $4\frac{1}{2}$ " Flanged Sector Plate and braced by two  $5\frac{1}{2}$ " Strips, as shown in the illustration. The reciprocating arm consists of two  $5\frac{1}{2}$ " Strips, one above the table and the other underneath it, joined together by two  $2\frac{1}{2}$ " Strips 1 bolted to the  $5\frac{1}{2}$ " Strips in the manner illustrated.

The arm is pivoted on a lock-nutted bolt through the holes of two Reversed Angle Brackets, which are spaced from the  $1\frac{1}{2}$ " x  $\frac{1}{2}$ " Double Angle Strip 2 by two Washers, and also through the centre holes of the  $2\frac{1}{2}$ " Strips 1.

The bracing of the table legs carries a  $3\frac{1}{2}$ " Crank Handle. On this is a cam built by bolting two Flat Brackets spaced by a Washer on each

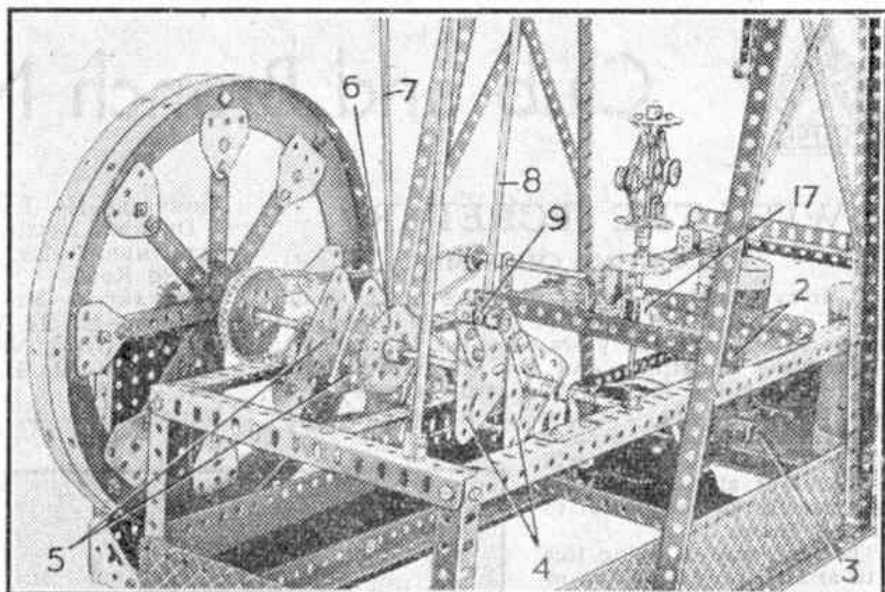

Fig. 2. A close-up view of the Beam Engine showing details of the crankshaft and governor.

side of a Bush Wheel, together with a Road Wheel and a 1" fixed Pulley. The positions of these will be clear from the illustration. A piece of wire is stretched from the end hole of the upper  $5\frac{1}{2}$ " Strip to that of the  $5\frac{1}{2}$ " Strip under the table, and passes through the appropriate hole in a  $4\frac{1}{2}$ " Flanged Sector Plate. This represents the saw blade.

A quick return stroke is effected by doubling a small Driving Band 3 over the arm and looping it on to a Cranked Bent Strip 4, through which the  $1\frac{1}{2}$ " Rod 5 is pushed. If desired, the *Magic Motor* can be bolted to the front leg of the fret-machine and the Driving Band fitted around the 1" Pulley. If a Motor is used, it is advisable to strengthen the front legs by connecting them together with a Double Angle Strip bolted near their lower ends.

Parts required to build Fret-machine: 8 of No. 2; 2 of No. 5; 4 of No. 10; 2 of No. 12; 1 of No. 17; 1 of No. 17a; 1 of No. 19s; 1 of No. 22; 1 of No. 24; 2 of No. 35; 21 of No. 37; 1 of No. 37a; 8 of No. 38; 1 of No. 44; 1 of No. 48; 1 of No. 54a; 1 of No. 111c; 2 of No. 125; 2 of No. 180; 1 of No. 187.

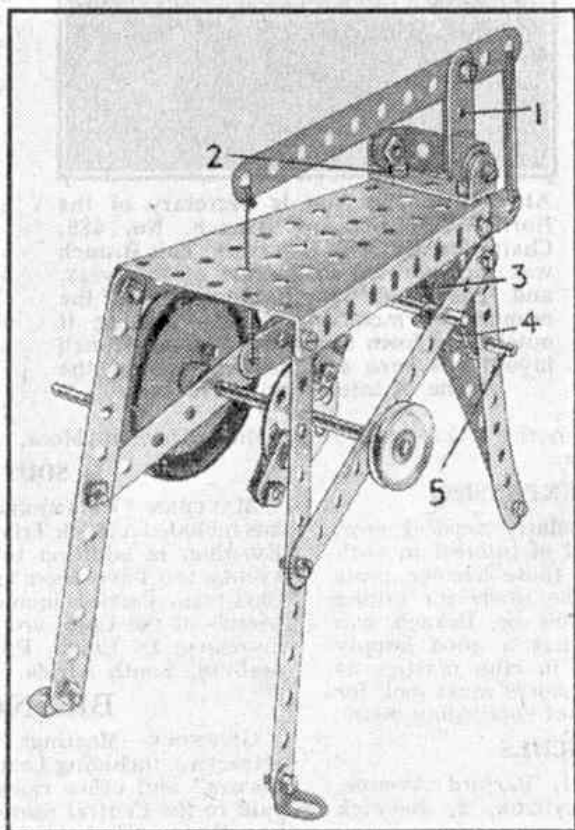

Fig. 3. A simple fret-machine that operates realistically.

# New Meccano Models

## Twin-Cylinder Beam Engine—Tandem Bicycle and Sidecar

THE construction of the fine model beam engine shown in the lower illustration on this page is begun with the framework, which consists of two "A" frames 1 built up from 18½" Angle Girders. These are attached to similar Angle Girders and are bolted to a 7½" Angle Girder and a 7½" Strip. A compound Angle Girder 2 is attached to the side of each "A" frame, and provides bearings for the crankshaft. The cylinders are secured to the other ends of these Girders.

The beams 3 are operated by the piston rods 4, which are 8" long and are mounted in the upper ends of the cylinders. These piston rods are pivotally attached to two 4½" Strips that also are pivoted at their upper ends to their respective beams. The beams are constructed as shown in the illustration. They are attached centrally to Bush Wheels mounted loosely on an 8" Rod 5 secured in the Bush Wheels fixed to the Circular Plates of the "A" frames. The connecting rods 6 are formed from 5½" and 9½" Strips pivoted at their upper ends to the beam, and at their lower ends to the cranks.

Each crank is constructed from two 2½" Triangular Plates 7, to which are bolted a 3½" Strip and a counterweight consisting of five 2½" Strips remote from this Strip. The crank pins are 1" Rods held in two Cranks bolted to the outer ends of the 3½" Strips.

The front crank is mounted on a 2½" Rod journaled in the framework, and its inner component is attached by a 2" Rod to the second crank arranged in the position shown. The latter Rod is mounted in 1½" Strips bolted to 5½" Angle Girders attached to the base. The outer component of the rear crank is fixed to a 6½" Rod on which is mounted the flywheel. The bearings for the Rod are provided by the framework and the flywheel casing, constructed from 5½" × 3½" Flat Plates bolted to Angle Girders attached to the frame.

The construction of the governor and mounting are

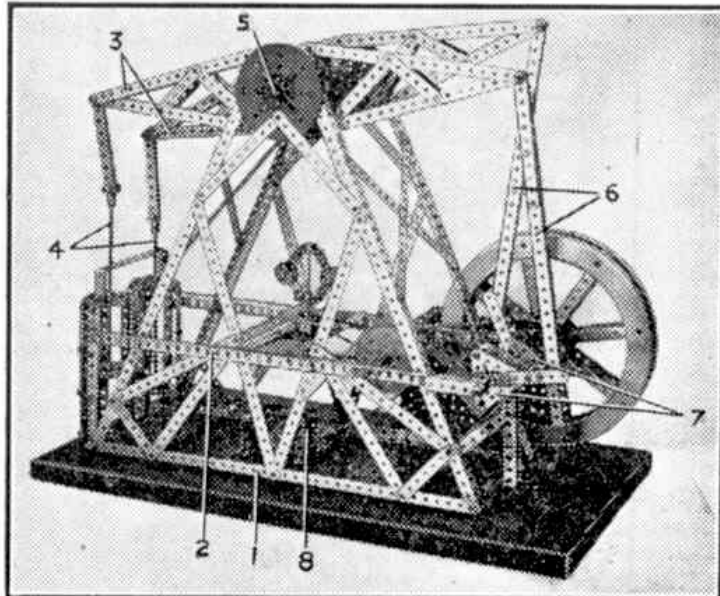

A model of a beam engine, of the type once used for pumping water out of mines as well as for driving machinery.

clear from the illustration, and the drive is transmitted to it through a 1½" Pulley fixed on a Rod driven from an E1 or E120 Electric Motor 8. The Rod in turn drives the crankshaft, as shown.

Parts required to build model Beam Engine: 4 of No. 1; 24 of No. 1a; 9 of No. 1b; 13 of No. 2; 57 of

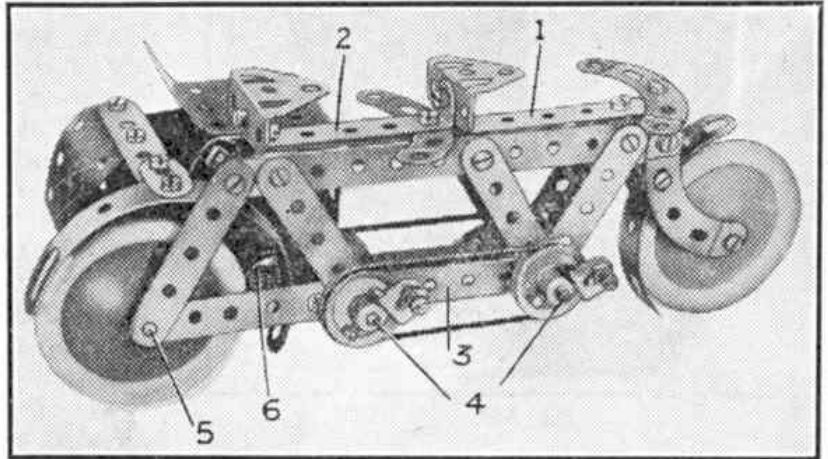

This fine tandem bicycle and sidecar is built from the contents of Outfit No. 3.

No. 2a; 8 of No. 3; 8 of No. 4; 29 of No. 5; 16 of No. 6; 10 of No. 6a; 6 of No. 7a; 4 of No. 8; 1 of No. 8b; 4 of No. 9; 6 of No. 9b; 1 of No. 9d; 16 of No. 11; 30 of No. 12; 1 of No. 12b; 4 of No. 13a; 1 of No. 14; 1 of No. 15b; 1 of No. 16a; 1 of No. 17; 10 of No. 18b; 2 of No. 20a; 1 of No. 21; 5 of No. 22; 1 of No. 23; 8 of No. 24; 378 of No. 37a; 354 of No. 37b; 78 of No. 38; 2 of No. 45; 11 of No. 48; 9 of No. 52a; 31 of No. 59; 4 of No. 62; 4 of No. 62b; 2 of No. 70; 4 of No. 76; 1 of No. 94; 2 of No. 95b; 1 of No. 96; 1 of No. 96a; 6 of No. 109; 1 of No. 111a; 20 of No. 111c; 2 of No. 116a; 2 of No. 125; 1 of No. 133; 1 of No. 133a; 2 of No. 146a; 2 of No. 167b; 1 of No. 186c; 1 E1 or E120 Electric Motor.

The model shown in our upper illustration is constructed from Outfit No. 3 and is driven by a *Magic* Motor housed in the sidecar. The bicycle is assembled by bolting two ½" × ½" Angle Brackets and a Double Bracket respectively ½" from each end of a 5½" Strip 1. Two similar Strips stepped backward one hole are attached at each side to the Angle Brackets and Double Bracket. The front wheel unit is constructed as shown, and is fixed to a ½" Bolt passed through the front end hole of the Strip 1.

A 2½" × ½" Double Angle Strip 2 is bolted to the rear end of the Strip 1, and a Trunion is attached to each of its turned-up ends. Four 2½" Strips are bolted on each side of the frame, and these are linked to 5½" Strips 3 by two 2" Rods 4 and a 3½" Rod 5. The two Rods 4 carry at their ends 1" Pulleys, to which the pedals are attached by Angle Brackets. The Pulleys mounted on the off side are connected by a 6" Driving Band, and those on the near side by a 10" Driving Band, that passes round the Rod 5 and over a ½" loose Pulley lock-nutted to a Flat Bracket 6 bolted to the frame.

The sidecar consists of a *Magic* Motor to which are bolted a 5½" × 1½" and two 2½" × ½" Flexible Plates that are attached also to a 2½" × ½" Double (Continued on page 268)