

# Scientific Apparatus in Meccano

## Microscope Accessories made by Dr. Ernest Bade

### I.—AN ELECTROCUTING DEVICE FOR MICROSCOPIC ANIMALS

THE wonderful adaptability of the Meccano system is well-known to most "M.M." readers, but it may come as a surprise to some people to learn that Meccano can be utilised in constructing delicate apparatus for use in connection with the study of microscopy. Meccano is used by Dr. Ernest Bade in the construction of all kinds of instruments and experimental apparatus that he uses in his scientific studies. We have received particulars of a number of these instruments, and details of one are given in full below. We propose to include descriptions of others in the Magazine from time to time.

Nature study is a subject that appeals to most of us, and without doubt it forms one of the most interesting and instructive spare-time occupations. While a great deal of pleasure may be obtained by studying the animals, birds or insects that are visible to the naked eye, an entirely new sphere of exploration may be opened up by means of a microscope. The teeming life that goes on in the air or in water and vegetation is of absorbing interest.

Doubtless, there are many "M.M." readers who have in their possession, or are able to make use of, a microscope. The instrument need not necessarily be an expensive one as it is quite possible to study the form and actions of some of the very small animals present in, say, a drop of rain or pond water with quite a simple instrument. In many cases, when examining specimens of this kind, it is required to mount them between thin slips of glass, so that they may be filed for future reference. It is here that a difficulty occurs, for it is practically impossible to kill such tiny animals in the ordinary manner without totally destroying their original shape.

With the apparatus about to be described, however, it is possible to execute a minute animal instantaneously by pressing a switch, so causing a high-voltage current generated by a spark coil to pass through the animal. The electrocuted specimen may then be studied at leisure.

It will be seen from the illustration that, in addition to the microscope and Meccano parts, a spark-coil is required to complete the apparatus, and the rather high cost of one of these coils might at first deter readers from carrying out the experiments. There is no necessity to purchase a brand new coil, however, for a second-hand article, which can be bought at many electrical stores, will be found quite satisfactory. The coil shown in the illustration is of an old "army" type used in field transmitters during the war, and many dealers in government surplus materials are willing to sell these coils for quite a small sum.

Again, a spark coil, somewhat similar to that illustrated, was at one time fitted to the Ford car, and it should be quite a simple matter to obtain one of these from a garage or electrical shop, for a few shillings.

#### Commencing to Build the Instrument

The standards holding the glass plate should first be constructed. Each consists of two  $4\frac{1}{2}$ " Angle Girders spaced apart at their upper ends by  $2\frac{1}{2}$ " Angle Girders and at the bottom by  $5\frac{1}{2}$ " Angle Girders. The upright Girders are further strengthened by  $4\frac{1}{2}$ " and  $2\frac{1}{2}$ " Strips bolted in the positions shown and spaced by a  $2\frac{1}{2}$ " Angle Girder held to the Strips by means of Angle Brackets.

When these standards have been completed a strip of clear glass, approximately  $6" \times 2"$ , should be obtained, and two holes bored in it to receive the Terminals shown. The drilling of the holes can be carried out with the aid of a three cornered drill, but those who do

not wish to undertake this operation (which calls for considerable care if the glass is to be drilled properly, and not cracked) may avoid the necessity of passing bolts through the glass by using clips to hold the glass in place. The clips may consist of Flat Brackets bolted to the  $2\frac{1}{2}$ " Angle Girders on which the glass plate rests, and the Terminals should be connected to them. Two clips should be used at each end of the plate.

The two standards should next be screwed down to a base of hardwood or some other insulating substance and the glass plate placed on top of the supports and fastened in position.

In the illustration each end of the plate is shown secured by means of a 6 B.A. Bolt pushed through the centre slot in the  $2\frac{1}{2}$ " Angle Girder and also through the drilled hole in the plate. A 6 B.A. Nut and Terminal is screwed on each Bolt so that short lengths of stiff wire may be mounted in the positions indicated.

A 6 B.A. Bolt, Nut, and Terminal is attached to one of the  $4\frac{1}{2}$ " Angle Girders of each of the standards, and lengths of wire (preferably of the rubber covered type) are taken from these terminals to the secondary terminals mounted on one side of the spark coil case.

The press-switch should next be constructed. The base of the switch consists of a  $5\frac{1}{2}" \times 2\frac{1}{2}"$  Flanged Plate having attached to it a Double Bent Strip and two 6 B.A. Bolts fitted with Terminals. One of these Terminals is insulated from the Plate by means of an Insulating Bush and Washer but is connected by a length of wire to a second insulated 6 B.A. Bolt fastened to the centre of the Plate.

The other Terminal is in electrical contact with the Plate. The switch arm consists of a  $5\frac{1}{2}"$  Strip rigidly secured to the Double Bent Strip and fitted with a 6 B.A. Bolt and a Flat Trunnion 3. Upon depressing the latter the 6 B.A. Bolts are brought together and thus current can flow between the two Terminals of the switch.

A length of wire 4 should be taken from one Terminal of the switch to one pole of a 6- or 4-volt accumulator. The wire 5 is attached to the second terminal of

the accumulator and its other end is fastened between the binding nuts of one of the primary terminals mounted on the spark coil box. Finally, a length of wire connects the other primary terminal and the second terminal of the switch.

All is now ready for carrying out the experiment. The two short wires should be arranged so that their ends are about  $\frac{1}{8}"$  apart. Upon depressing the Flat Trunnion of the switch a spark should pass between the ends of the short wires. If a spark cannot be obtained the ends of the wires should be brought nearer together and the interrupter screw 6 on the end of the coil box should be adjusted. Having obtained the spark the drop of water, known to contain the minute animal that is to be examined, is next placed on the glass slip. The latter should then be placed on the glass plate so that the drop can be viewed through the eyepiece of the microscope in the usual manner, care being taken to see that the ends of the two wires dip into the fluid.

When the animal is seen to be in a suitable position between the ends of the wires the switch should be closed by depressing the Flat Trunnion and a charge of electricity will pass between the ends of the wires, thus electrocuting the animal. The dead animal may then be mounted between glass slips in the usual manner.

Other interesting experiments may be carried out by substituting specimens of plant and animal tissue in place of microscopic animals, and noting the varying effect that the electric discharge has upon them.

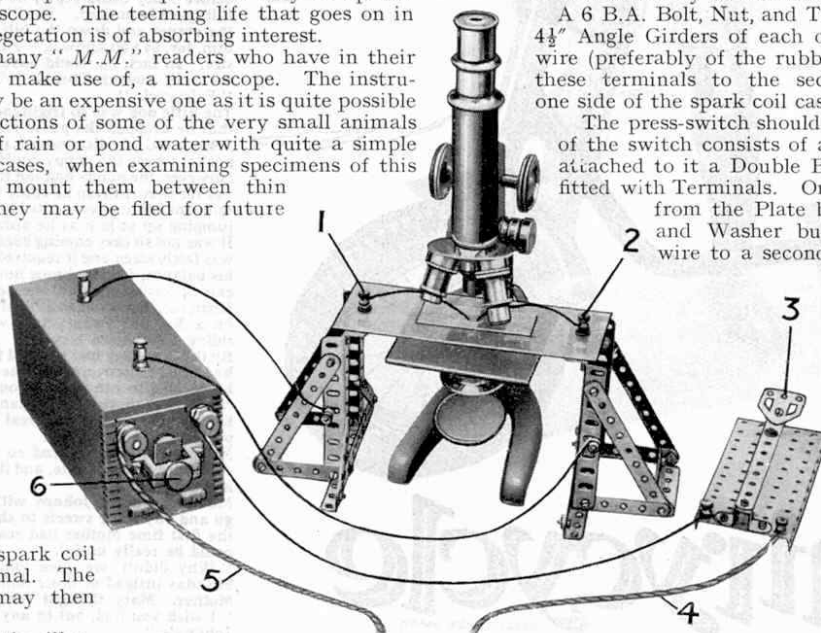

General view of the apparatus, showing the spark-coil and microscope in position

# Scientific Apparatus in Meccano

## Microscope Accessories made by Dr. Ernest Bade

*This article is the second of a series in which we propose to describe some uses that have been found for Meccano in the field of science. In the November issue we described an instrument designed by Dr. Bade for electrocuting small aquatic animals for microscopical study. This month an apparatus for photographing objects through the microscope is dealt with, and also a device that will project microscope slides on to a screen in a similar manner to a magic lantern. In each case the apparatus is the work of Dr. Bade.*

### II.—PHOTO-MICROGRAPHIC DEVICE AND A SLIDE PROJECTOR

THERE must be hundreds of Meccano boys who obtain hours of enjoyment from the study of minute objects under the microscope. But while much pleasure can be derived from studying the wonders of nature that are hidden from the naked eye, there is one disadvantage concerned with microscopical study. Every "hobbyist" expects on the completion of his work to have some material result to show for his labour, which he can display to his friends and fellow enthusiasts when suitable occasions arise.

Objects mounted upon slips of glass form of course a more or less permanent record of the microscopist's work, but the trouble and delay that must necessarily be expended in finding the slide and focusing it in the microscope proves this method to be inconvenient and unsatisfactory, especially when the specimens are required to be shown to several people simultaneously. What is required, therefore, is a photograph of the specimen as seen through the magnifying lenses of the microscope.

#### Photographing Microscopical Specimens

At first it might be thought that in order to secure photographs of microscopical specimens a very elaborate and costly instrument would have to be obtained, but this is not the case. With the aid of Meccano, an old camera "bellows," a plate holder and a few plates, it is possible to take photographs in every way equal to those appearing in scientific publications dealing with microscopy.

Proof of this fact will be found upon glancing at the circular photograph reproduced upon this page. The photograph shows a section of the stem

of a bulrush and the clarity with which the various minute cells are brought out will be noted. (We may mention here that the actual specimen from which the photograph was taken was cut with the aid of a Meccano microtome, an instrument used for cutting very fine

slices of plant and animal tissue. This model will be described in detail in next month's issue).

Before commencing the construction of the apparatus it will be necessary first to obtain an old plate camera of the bellows type. In some cases this may already be in the reader's possession, but if not he should make inquiries of friends interested in photography. Many amateurs have a camera of this type lying aside somewhere, neglected in favour of the more modern film type.

If one cannot be found, however, it should be possible to pick one up from any second-hand dealer who specialises in scientific apparatus. Again, if all else fails, it is not a difficult matter to substitute for the camera bellows a collapsible cardboard connection. The simplest plan is to make two tubes, one slightly smaller in diameter than the other, so that they can slide together or extend like a telescope. To ensure a perfectly light-tight connection, a piece of black felt or similar material should be secured round the end of the inner tube. The tubes should be fastened to wooden frames similar to those shown in the photograph.

If an old camera has been secured it will be necessary to remove the folding portion that acts as the base when the bellows are extended. The lens, if any is still present, should also be removed, as it is not required in photographing the objects.

A short piece of rubber tubing serves to connect the camera to the eyepiece of the microscope. In making the connection to the camera, the end of the tubing should be rolled back to form a flange.

The tubing may then be placed over the opening left after removing the lens, and secured by glue or a few tacks to the lens panel of the camera. Alternatively, a short cardboard tube may be glued into the aperture and the tubing tied over its projecting end in the same way as it is attached to the microscope eyepiece. In either case it is imperative that light-tight connections should be made when fastening the tubing.

As soon as the camera and connecting pieces have been

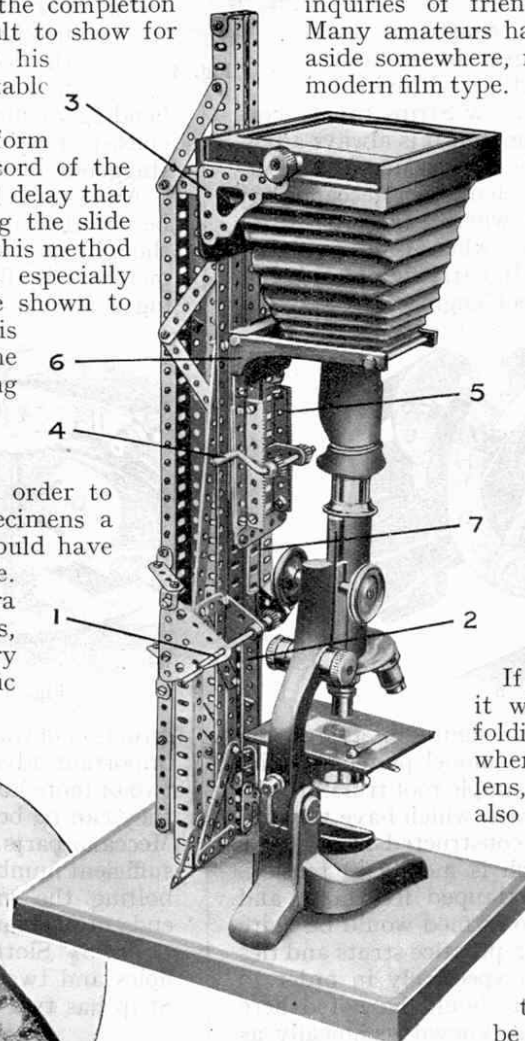

Fig. 1. General view of the photo-micrographic device, and (left) photograph of a bulrush section taken with the apparatus

assembled the construction of the Meccano portion of the apparatus may be commenced.

It will be seen on referring to Fig. 1 that the main framework which supports the sliding members consists of  $18\frac{1}{2}$ " Angle Girders fastened to a strong wooden base by means of Flanged Brackets held down by wood screws. Two other  $18\frac{1}{2}$ " Girders (their upper ends can be seen projecting above the main framework) are held apart by means of a  $1\frac{1}{2}$ " x  $\frac{1}{2}$ " Double Angle Strip. This leaves a slot into which further Angle Girders bolted together can be passed. To these Girders the framework supporting the photographic plate is attached by means of the Architraves 3, the latter being bolted, in turn, to a Plate fastened to the sliding Girders.

Before sliding the Angle Girders into the slot the Rack Strip 2 should be bolted to them. The wooden portion 6 is bolted to a frame consisting of  $5\frac{1}{2}$ " x  $2\frac{1}{2}$ " Strips, which frame slides up and down the movable Girders 7 and carries two Rack Strips 5. The Crank Handle 4 should next be fitted in its journals, which consist of  $1$ " x  $1$ " Angle Brackets, and the  $\frac{1}{2}$ " Pinions that mesh with the Rack Strips 5 should be secured to the Crank Handle.

After assembling the sliding members the Crank Handle 1 carrying a  $\frac{1}{2}$ " Pinion that meshes with the Rack Strip 2 should be mounted in its journals, which consist of three  $2\frac{1}{2}$ " Triangular Plates. It will be noted that two Collars are slipped on to the Crank Handle to hold it in place.

The framework is completed by attaching the various Strips seen in Fig. 1, which strengthen the whole and prevent any "shake" which might affect adjustments. The microscope itself can now be placed in position on the baseboard and the free end of the tubing tied over the eyepiece. The slide containing the specimen that is to be photographed is placed in position on the stage of the microscope and a plate of ground glass mounted in the plate frame of the camera.

The image of the specimen can be focussed on the ground glass screen by manipulating the Crank Handles 1 and 4 and also by the coarse and fine adjustments of the microscope itself. With a little practice the correct setting of the various controls will soon be

found so that a clear picture of the specimen appears on the ground glass.

Provided that a photographic plate has been placed in the plate holder, the screen can be withdrawn and the plate inserted in its stead. All that now remains is to expose the plate for a suitable duration of time, afterward developing and printing in the usual manner. It is of course impossible in this short article to give any definite particulars as to length of exposure, etc., but the experimenter should

have no difficulty in obtaining these after taking one or two trial photographs.

### The Meccano Slide Projector

While photographs obtained in the manner just described form an excellent record for the microscopist, occasion may sometimes arise, such as on Meccano Club Night or at a party, when it is required to show to a number of persons the magnified specimens as seen under the microscope. It is on such occasions that the simple Meccano projector set illustrated in Fig. 3 will prove extremely useful.

With the aid of this apparatus microscope slides may be projected upon a screen, in a similar manner to a magic lantern slide. Fig. 3 is a general view of the projector and Fig. 2 shows it partly dismantled.

In the construction of the projector the following will be required in addition to standard Meccano parts: A 6-volt electric bulb and a bayonet cap holder to receive it (the holder shown in Fig. 2 is one actually taken from a motor car, but the standard S.B.C. lamp holder can be used quite effectively); two small condensing lenses 7 and 9 (the lens 7 can be dispensed with without any great loss in strength and definition of the resulting image, but the lens 9 must be fitted and may conveniently consist of a small double convex lens such as those fitted to "pocket magnifiers"); a low power objective taken from the microscope. The latter article will of course, be already in the possession of the constructor.

The framework of the instrument should first be built up. The base consists of  $12\frac{1}{2}$ " Angle Girders spaced apart at each end by a  $4\frac{1}{2}$ " x  $2\frac{1}{2}$ " Flat Plate. The slide rails 2 are secured to these Girders by means of  $1\frac{1}{2}$ " x  $\frac{1}{2}$ " Double Angle Strips and Angle Brackets. It will be seen that at one end the Strips 2 are connected together by a  $3\frac{1}{2}$ " Angle Girder, and two vertical Strips bolted to this form a clip in which can be slipped the slide containing the specimen that is to be projected.

The next portion to be assembled

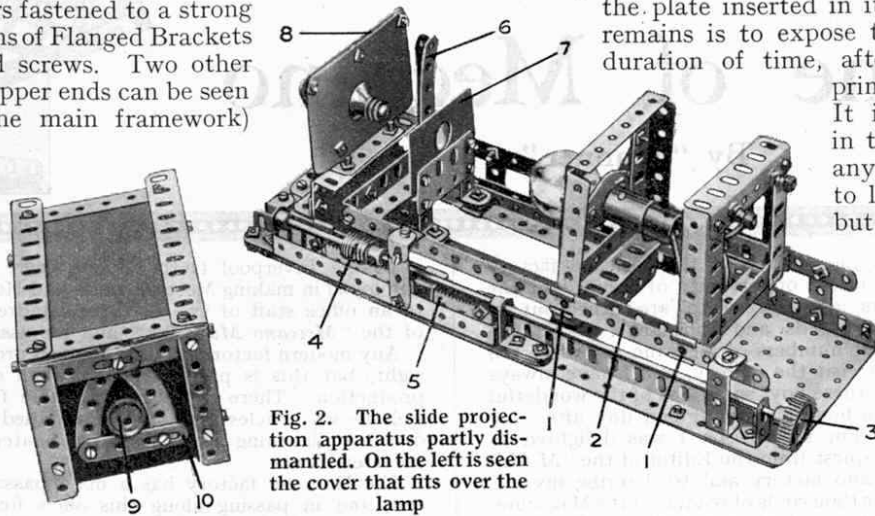

Fig. 2. The slide projection apparatus partly dismantled. On the left is seen the cover that fits over the lamp

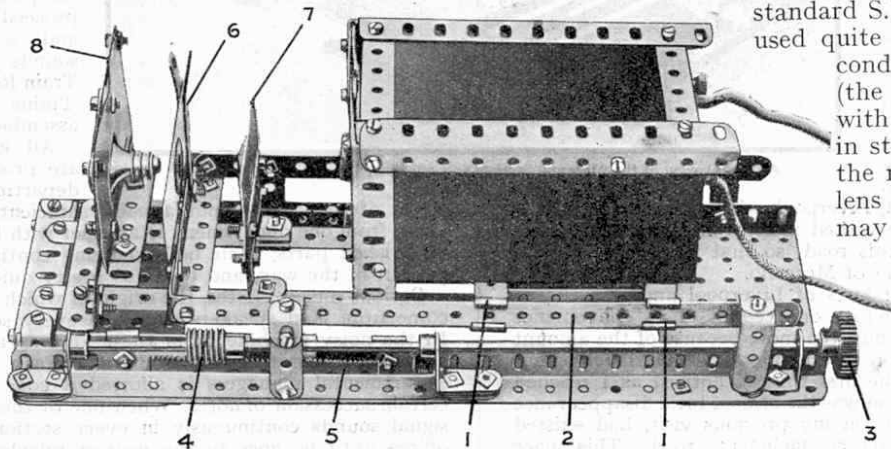

Fig. 3. General view of the projector set. The disposition of the various lenses can be seen clearly in this illustration

The next portion to be assembled

The next portion to be assembled (Continued on page 81)

**Scientific Apparatus in Meccano***(Continued from page 41)*

is the framework holding the lamp bulb; as will be seen this consists of two square end pieces composed of 3" Angle Girders bolted together. The support for the lamp holder may consist of either a piece of stout cardboard on tin plate having a hole cut in it sufficiently large to admit the screwed portion of the holder. Wires from the two poles of the holder are taken to terminals bolted to, but insulated from the frame.

The objective taken from the microscope is held between two pieces of stout cardboard or sheet tin 8. These are secured by 2½" Strips that are bolted to short Angle Girders which, in turn, are secured to two 5½" Strips. These Strips are bolted at one end to the framework holding the lamp and at the other end to a 3" Angle Girder, the ends of which are fastened by Angle Brackets to further Strips that slide in Eye Pieces bolted to the inner sides of the base Angle Girders.

The Rack Strip 5 is attached to one of these Strips by means of a Double Bracket. It is kept in mesh with the Worm 4 which is carried on an 11½" Rod. On turning the 1" Gear Wheel 3, the framework carrying the objective holder 8 and the lamp frame will move backward or forward while the slide holder 6 remains stationary. The holder carrying the condensing lens 7 is mounted on Eye Pieces so that it may be pushed to and fro on the 5½" Strips that are secured to the lamp framework, and the light focussed accordingly.

It now remains to construct the cover that is fitted over the lamp and incorporates the second condensing lens 9. Heavy cardboard should be used for the cover, so that all light is excluded except that issuing from the lens.

Operation of the instrument is very simple. A screen should first be arranged in the room where the demonstration is to take place. It may consist of a white sheet or a portion of the wall if it is of a plain white colour. The lamp having been coupled to an accumulator or transformer, etc., the slide is placed in its holder 6 and the wheel 3 rotated backward or forward until the specimen is seen to be in focus on the screen. The condensing lens 7 should then be adjusted.

**How to Use Meccano Parts—***(Continued from page 39)*

Meccano. Curved lines are not often required in mechanical engineering, but since Meccano is equally at home in the civil branch of the profession, arcs and circles, etc., are almost essential adjuncts to the system.

In mechanical engineering the Curved Strips prove useful in the construction of rotating mechanisms. Fig. 5 shows a useful flywheel built up from four 2½" small radius Curved Strips. The diameter of the circle so formed is not standard with the system, and therefore, in order to form spokes for such a wheel, it is necessary to connect 2½" Strips between the Curved Strips by means of Flat Brackets, the slotted holes of which allow the Strips to be secured centrally.

Complete circles suitable for flywheels, etc., may also be built up from eight 2½" large radius Curved Strips or from four 3" Curved Strips.

Fig. 6 shows how the Circular Strip may be used in a built-up roller bearing.

Flat Brackets, which are really two-hole Strips, will be dealt with in Class C, as also will Single, Double, and Cranked Bent Strips. Rack Strips are in Class O.

**Meccano Biplane—***(continued from page 50)*

It is attached to its respective fixed portion by Hinges 49. The two units—consisting of one fixed and moving plane—are spaced apart by 2½" Flat Girders 50 attached by means of ½" × ½" Angle Brackets to the Flat Girders 47. Bolted to the Flat Girders 50 are Hinges to which the rudders 51 are attached. The rudders each consist of a 2½" Triangular Plate, along the edges of which two 2½" Strips and a 1½" Strip are bolted.

Double-arm Cranks 53 are bolted to the two outside 2½" Flat Girders 50, and Collars 54 are secured on the ends of 1½" Rods held in the bosses of the Double-arm Cranks. The rudder wires 55 are to be taken round the shanks of ordinary bolts that are inserted in the set-screw holes of the Collars 54.

Two ¾" Bolts 56 are attached to the moving portion of each elevator at the extreme trailing edge. The control wires 57 are secured to these bolts, and are led through guides 58 consisting of Angle Brackets bolted to the leading edges of the Flat Girders 46.

The remainder of the instructions for completing this model will appear in next month's "M.M." In that number we shall publish illustrations of the wings, engines, landing wheels and a splendid front view of the complete model. Each part will be described in detail and full instructions will be given for assembling the various units.

**Famous Inventions—***(continued from page 20)*

The "Fire Suds" pump has two entirely separate gunmetal pump chambers, of positive action type, driven at engine speed by an extension of the first motion shaft through the change speed gearbox. One pump chamber takes its supply from either of the alkaline solution tanks and the other from one of the acid solution tanks. The suction pipes leading to the tanks are controlled by a group of gunmetal valves with copper pipes arranged conveniently for operation from the footboards of the engine.

The delivery from each pump chamber is taken to a hydraulic hose reel having two separate extensive lines of rubber hose, jointed together at the extreme end by a short length of rubber delivery hose with branch-pipe and nozzle. The acid and the alkaline solutions are pumped through the separate lines of hose, and mix at the base of the branch-pipe, thus forming "Fire Suds."

All the tanks are kept charged ready for immediate use on arrival at a fire. With the engine running, either or both the pumps are put into gear by a single lever to the left of the driver, and the clutch is then let in, bringing the pumps into operation. By means of control valves the outlets of one alkaline and of one acid tank are opened and the solutions are pumped through the hoses, the resulting mixture being directed on to the fire.

When the first solution tanks are exhausted, as indicated by a pressure gauge, the outlets are closed and those of the second two tanks are opened by the manipulation of the control valves. Before there is time for the latter to be exhausted, the first tank can be recharged with alkaline solution, and the process repeated until all six acid tanks have been emptied, by which time 1,800 gallons of "Fire Suds" will have been produced.

**Our Daily Bread—***(continued from page 23)*

and causes the grain to lose its starch. The risk of an outbreak of the disease is greatest at the end of a rainy growing season, for the fungus flourishes in damp weather. There have been no widespread epidemics since 1816, however, when the districts of Lorraine and Burgundy were ravaged by the disease at the end of a particularly wet summer, and now that wheat is displacing rye, further outbreaks on a large scale are very unlikely.

**New Meccano Models—***(continued from page 47)*

5 of No. 35; 36 of No. 37; 1 of No. 40; 2 of No. 48a; 1 of No. 52; 6 of No. 111c; 2 of No. 125; 2 of No. 126; 2 of No. 126a.

**Stone Sawing Machine**

No doubt many Meccano boys have watched giant stone sawing machines cutting their way slowly but surely through huge blocks of stone that sometimes weigh several tons. The designer of the Meccano model shown in Fig. 7 has endeavoured to reproduce one of these machines with the aid of a small Outfit, and we think readers will agree that he has succeeded remarkably well.

The swinging saw consists of a 5½" Strip lock-nutted to a 2½" Strip at each end, and these 2½" Strips are supported on 3½" Axle Rods journalled in the vertical members of the model. One of the Rods carries two 1" Pulleys that are clamped firmly against the 2½" Strips, and two further Pulleys are secured on the end of this Rod and clamped against another 2½" Strip, which is connected pivotally to a Bush Wheel by means of a 5½" Strip. The Bush Wheel is secured to a Crank Handle journalled in two Flat Trunnions bolted to the side frames of the model. Hence on rotation of the Handle the saw swings to and fro in a very realistic manner.

The Stone Sawing Machine comprises the following parts: 4 of No. 1; 7 of No. 2; 1 of No. 3; 3 of No. 5; 2 of No. 16; 1 of No. 19s; 4 of No. 22; 1 of No. 24; 6 of No. 35; 38 of No. 37; 4 of No. 37a; 1 of No. 48a; 2 of No. 126a.

**Chocolates for New Year**

The House of Cadbury have recently brought out many new chocolates of quality, the new assortments including Lady Betty, Bermuda, Riverside and the new Prince of Wales chocolates in their richly coloured box. We take this opportunity to remind our readers that Cadbury's cater for those who like hard centres by an assortment of that name, and for those who prefer soft centres there are such assortments as Esmond and Countess Cremes. Most Meccano boys have a little extra pocket money at this time of the year and we have no doubt that after carefully balancing the attractions of new Meccano parts and chocolates, they will manage to arrange matters so as to allow of a visit to the tuckshop!

**A Pocket Surveying Instrument**

An instrument that will be of interest to all boys is the Pocket Surveyor designed by Mr. G. C. Sherrin, and produced by George Philip & Son Ltd., 32, Fleet Street, London, E.C.4. Although it is simply made and costs only 2/6, it is very practical and may be used for an astonishing variety of measurements. With its aid the widths of rivers and the heights of hills and buildings are easily found, and even complete surveys may be made with fair accuracy.

The Surveyor will be especially valuable to Meccano boys who wish to reproduce a large engineering structure, such as a bridge, for they will be able to measure its dimensions and plan an exact scale model. Other interesting uses are suggested in the booklet that accompanies the instrument. Among these may be mentioned the levelling and correct marking out of football fields, tennis courts and camp sites.

The instrument is made of oxidised steel, and is rustless and unbreakable. It is only five inches in length, and when closed occupies little more space than a pocket knife.

# Scientific Apparatus in Meccano

## Microscope Accessories made by Dr. Ernest Bade

*This article is the third of a series in which we describe various uses that have been found for Meccano in the field of science. In the first two articles we described an instrument designed for electrocutting small aquatic animals for microscopical study, an apparatus for photographing objects through the microscope, and a device for projecting microscope slides on to the screen. Below we deal with a Meccano microtome, a wonderful precision instrument for use in connection with the microscope. All the apparatus so far dealt with is the work of Dr. Ernest Bade.*

### III.—A REMARKABLY EFFICIENT MECCANO MICROTOME

IN describing a photo-micrographic device last month (see January issue, page 40) mention was made regarding an instrument known as a "microtome" used for cutting very thin slices of plant and animal tissue. The use of such an instrument will be unknown to many of our readers, although any who are particularly interested in microscopical study will know that without a microtome their field of experiment would be considerably limited. The reason for this is that although the student may obtain considerable information of a substance by examining its external appearance under the microscope, he must study its internal construction and the formation of the cells of which it is composed if he wishes to obtain a complete knowledge of the specimen.

This cannot, however, be carried out directly as in practically every case the substance that is to be examined will be of an opaque or semi-opaque nature. If on the other hand we had some means available whereby an extremely thin section could be obtained of the substance, it would become transparent and

its structure would consequently be discernable. The photo-micrograph of a section of bulrush illustrated in the January issue obtained with the aid of this instrument demonstrates its extreme usefulness, and the way in which the tiny cells comprising the major portion of the bulrush have been severed, and so exposed to view, will be noted.

Naturally, very great precision is essential in the manufacture of an instrument of this type, and it is not therefore surprising that its cost varies between £5 and £20. It is therefore all the more remarkable, that an instrument capable of dividing a portion of matter

into a number of very thin slices can be constructed with Meccano parts, and in addition to testifying to the system's adaptability, it also demonstrates the remarkable accuracy of each component part. We may mention also that while in most of the manufactured products the experimenter is required to manipulate the blade himself (an operation that requires a certain amount of skill), the action of the knife in the Meccano model is entirely automatic, the operator only having to push a frame work up and down. By an ingenious arrangement of gearing, the knife, which consists of a lateral sliding action, in addition to its forward cutting motion, and consequently a very smooth cut is obtained.

The object to be cut is embedded in paraffin wax or similar substance, and an ordinary safety blade, which moves forward with a sideways motion, cuts perfectly a section as amazingly thin as two thousandths of an inch! The only non-Meccano parts used in the model are the razor blade and the small metal tube for holding the specimen to be cut. (A Sleeve Piece would serve quite well in place of this tube).

The construction of the model is quite simple. The sides of the frame consist of 5½" x 2½" Flanged Plates spaced apart by 2½" x ½" Double Angle Strips, and a 7½" Angle Girder is bolted to the top flange of each of the Plates, as shown in the illustrations.

A Ratchet Wheel is secured to one end of a Rod that is journalled in the Flanged Plates and that also carries a Worm. The latter meshes with a 1" Gear on a vertical Rod to which is secured a second Worm meshing with a Rack Segment. The Rack Segment is bolted rigidly to a Crank which, in turn, is secured to a transverse shaft

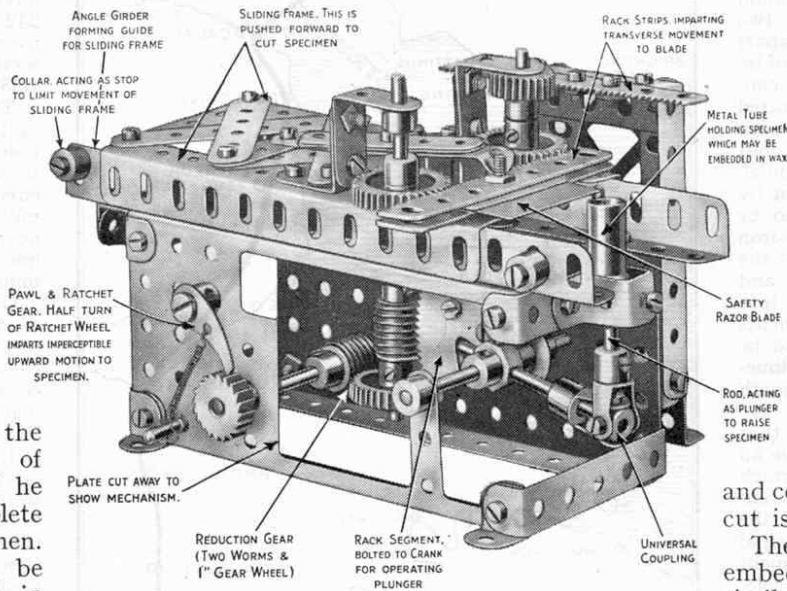

Fig. 1. View of Microtome with side Plate partly cut away to show the gearing operating the plunger, etc.

### Parts Required

The following is a complete list of parts required to build the Meccano Microtome :—

5 of No. 4	2 of No. 12B	40 of No. 37	1 of No. 97
4 " " 5	1 " " 16A	1 " " 45	3 " " 103G
2 " " 8B	2 " " 16B	4 " " 48A	3 " " 110
2 " " 9	2 " " 17	2 " " 52	2 " " 111c
2 " " 9B	2 " " 18A	2 " " 58	1 " " 115
4 " " 9E	1 " " 25	6 " " 59	1 " " 119
3 " " 12	3 " " 31	1 " " 62	1 " " 140
4 " " 12A	2 " " 32	1 " " 63	1 " " 147
1 Safety Razor Blade		1 Small Metal Tube	

A Ratchet Wheel is secured to one end of a Rod that is journalled in the Flanged Plates and that also carries a Worm. The latter meshes with a 1" Gear on a vertical Rod to which is secured a second Worm meshing with a Rack Segment. The Rack Segment is bolted rigidly to a Crank which, in turn, is secured to a transverse shaft

comprising two short Rods joined together by an Octagonal Coupling. A Rod is held in the transverse bore of the Coupling and carries at its outer extremity a Universal Coupling, in the other portion of which is held a short Rod that passes upward through the centre of the tube 7 (Fig. 2). The top of this Rod is fitted with a Collar or similar part to fit the diameter of the tube. If the latter consists of a Sleeve Piece, the top end of the Rod may be equipped with a  $\frac{1}{2}$ " fast Pulley, which will be found to be a sliding fit in the bore of the Sleeve Piece. The specimen to be cut is retained in place on the top of the plunger by means of a small quantity of paraffin wax and lard, etc.

The method by which the slicing motion is given to the razor blade is very ingenious. A sliding frame comprising two  $5\frac{1}{2}$ " Angle Girders braced by  $2\frac{1}{2}$ " and 3" Strips, slides on the up-turned flanges of the  $7\frac{1}{2}$ " Girders that are bolted to the  $5\frac{1}{2}$ " x  $2\frac{1}{2}$ " Flanged Plates, and two 1" Gears are mounted on the front end of the sliding frame as shown in the illustrations. On the Rod of the far 1" Gear in Fig. 1; a  $\frac{3}{4}$ " Pinion is

secured, and meshes with a portion of a Rack Strip 6 (Fig. 2) attached to a fixed portion of the frame of the model. In engagement with the 1" Gears are two Rack Strips 5 bolted face to face with the razor blade 4

clamped between them. They are held in mesh with the Gears by means of the Strips 8 pressing down on the upper one and

a Spring attached to the lower one and to the sliding frame.

When the frame is moved forward, the blade moves across the frame laterally at the same time, owing to motion imparted to the  $\frac{3}{4}$ " Pinion by the Rack Strip 6. Thus a perfectly clean cut is given to the specimen.

Stops in the form of Collars secured to either end of the  $7\frac{1}{2}$ " Angle Girders, limit the movement of the sliding frame. It will be seen that, by turning the Ratchet Wheel one or more teeth at a time, the thickness of the cut may be regulated to within very fine limits.

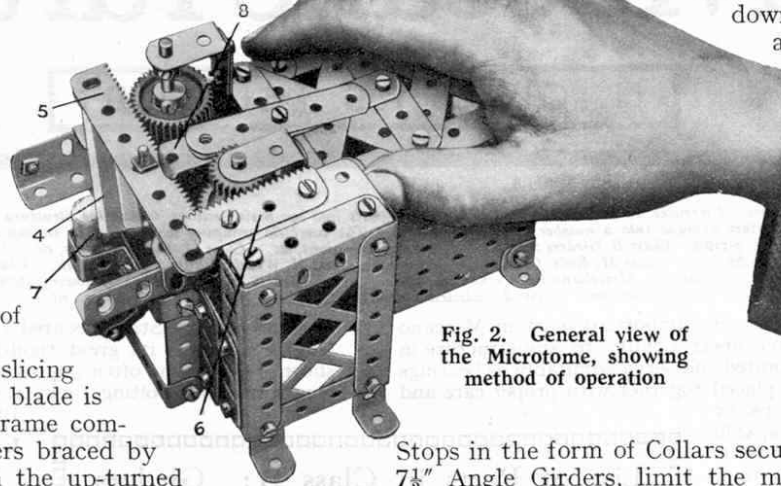

Fig. 2. General view of the Microtome, showing method of operation

Stops in the form of Collars secured to either end of the  $7\frac{1}{2}$ " Angle Girders, limit the movement of the sliding frame.

It will be seen that, by turning the Ratchet Wheel one or more teeth at a time, the thickness of the cut may be regulated to within very fine limits.

**A Run on the "Twentieth Century Limited"**

(Continued from page 99)

"thrashed" to her utmost limit.

Upward we go until at last, after 62 miles' continuous climbing, we reach the summit of Mount Washington. From here after a sharp drop to Pittsfield, where we may touch 70 to 80 m.p.h. the scenery is just one beautiful panorama after another.

Through sleepy towns and villages we tear, the speedometer hanging steadily on at the 72 mark, until, as we start to cross the historic Hudson River we commence to decelerate in readiness for our entry into the great Union Station at Albany, N.Y. Here, two minutes to the good, we detach our train, leaving it to be taken forward to Chicago by one of the new "Hudson Speed" type of engines of the New York Central. Recrossing the Hudson River we reach our resting place where "596" will be thoroughly inspected and washed in preparation for the return on the morrow.

No doubt you feel ready now for a wash and a sleep but that does not prevent tongues from chattering. How, asks somebody, would that great "Hudson Speed" or even our gallant "596" look at the head of the "Cornish Riviera" express! That reminds me of an amusing little incident that occurred to me quite recently. That day I was driving "598" on the "South Western Limited." We rolled into the terminal station of Boston and a few minutes later as I was looking over the engine a young fellow addressed me. It did my heart good to hear him speak. I am from England myself, you know, and he was from good old Lancashire! He was greatly interested in the engine and after a few moments' conversation he mentioned that he was an ex-Lancashire and Yorkshire Railwayman. I asked him how the engine would look running into Exchange Station, Liverpool. "By gum!" he replied, "I don't believe the beggar could get in!"

**Famous Trains**—(continued from page 109)

the first trough we have seen all the way from Liverpool!—and mount the  $2\frac{1}{2}$  miles at 1 in 125 to Belstead Signalbox. A quick run down to the Stour Valley, with a last "60" maximum, precedes a severe slowing over the North curve at Manningtree, which takes us on to the Harwich branch. Sharp ups-and-downs along the right bank of the Stour estuary have to be negotiated with our heavy load, and then, as we run down the final incline from Wrabness, the lights of our arrival being timed at 9.18 p.m. Parkeston Quay bear into view dead ahead.

We are not allowed to stand at the long platform any longer than is necessary to unload passengers and luggage, as the "Esbjerg Continental" is due from Liverpool Street at 9.31 p.m., the "Hook Continental" 11 min. after that, and the "Antwerp Continental" 10 min. later still. This is one of the reasons why our timings have been on the leisurely side, as punctuality of arrival at Parkeston is of vital importance, and there is ample margin for recovery of lost time should one of our many connections put in a late appearance *en route*. After leaving Parkeston Quay we have but another two miles to run, calling on the way at Dovercourt Bay, ere we "make the port of Harwich" at 9.31 p.m. We have had, as I am sure you will agree, a most interesting day.

**The New Channel Tunnel**—

(Continued from page 131)

each dining car would be 55 tons in weight. A train unloaded would weigh 505 tons, and would consist of three first-class corridor coaches, each accommodating 100 passengers; two third-class corridor coaches seating 132 passengers each; one dining car; one luggage van and one

locomotive. The passengers and luggage represent an additional 45 tons, so that a loaded train would weigh 550 tons.

The estimated total cost of the project is £189,177,094. Of this enormous sum the English "overland" section is estimated to cost £58,529,345, the Channel Tunnel £30,811,200, and the French "overland" section £99,836,549. It is calculated that the fare for the entire journey would be approximately £2; that for the journey to Boulogne £1, and the shorter journey from Ashford to Boulogne 10/-. Based on these figures, the gross receipts are estimated at £35,166,664 per annum, of which £23,209,998 would be required to meet working expenses, leaving a net profit of £11,956,666.

The interesting details of the proposed high-speed railway given in our article were published exclusively by "Modern Transport." We have been able to reproduce them through the courtesy of the Editor of that paper.

**How to Use Meccano Parts**

(Continued from page 135)

Another important function of the Circular Girders is illustrated in the Steam Shovel (Model No. 7.7, Special Instruction Leaflet No. 19.) where it is used as the upper guide rail of a built-up roller bearing unit (see also Standard Mechanism No. 106). The part is invaluable in building models of large cement-mixing machines, wagon tippers, and similar models where circular structures are necessary.

Channel Segments (part No. 119), which resemble curved channel girders, are dealt with in Class N (Wheels, Pulleys, etc.), as also are Ring Frames (No. 167B), which resemble the Circular Girder. Girder Brackets and Channel Bearings, which might be compared with very small girders, are included under Class C (Brackets, Trunnions, etc.).

# Scientific Apparatus in Meccano

## Laboratory Apparatus made by Dr. Ernest Bade

Some time ago we described a few of the many practical uses that have been found for Meccano in the field of science. These included the following devices constructed by Dr. Ernest Bade: Apparatus for electrocuting microscopic aquatic animals (see "M.M." for November, 1928); photo-micrographic device and a slide projector (January, 1929); and a microtome for cutting sections of animal tissue two thousandths of an inch thick (February, 1929). This month we are able to reproduce various interesting apparatus which Dr. Bade has constructed for use in chemical experiments.

### IV.—USEFUL MECHANICAL EQUIPMENT FOR THE AMATEUR CHEMIST

CHEMISTRY offers many advantages for the amateur who makes it his hobby and there must be a very large number of Meccano model-building enthusiasts who also obtain interest and instruction by carrying out some of the simpler experiments in this wide and fascinating branch of science.

Most of the various chemical substances that are required can be obtained in small quantities quite cheaply, and with the addition of a Bunsen, or even a spirit lamp, and a few glass vessels, test tubes, etc., the experimenter has all the essentials that are needed to start his hobby.

But just as the addition of a larger variety and quantity of parts enables the Meccano boy to extend his model-building activities, so a more comprehensive equipment will allow the amateur chemist to carry out more complicated and fascinating experiments, but alas! laboratory apparatus, like all other specialised equipment, is expensive, and in most cases quite beyond the pocket of the young chemist.

It is the object of this article, therefore, to show how Meccano can be employed to meet the want of efficient and cheap apparatus for the amateur's laboratory. The great advantage obtained by using Meccano apparatus in place of manufactured equipment lies in the interchangeability of the parts. Suppose, for instance, the experimenter constructs the bottle shaker shown in Fig. 1 and after using it in carrying out a number of experiments, finds that it will not be required for some time. It will then be quite a simple matter for him to dismantle the shaker and build up some other piece of equipment that will fulfil his immediate needs. With manufactured apparatus this cannot be done, and when out of use it merely serves as a dust collector of the most expensive order!

#### Bottle Shaking Device

The bottle shaker (Fig. 1) is constructed entirely from Meccano parts. The framework consisting of  $12\frac{1}{2}$ " and  $5\frac{1}{2}$ " Angle Girders should first be assembled, and to it is bolted a Meccano Electric Motor and the pair of  $12\frac{1}{2}$ " Angle Girders that comprise the rails on which the carriage runs. It will be seen that a  $5\frac{1}{2}$ "  $\times$   $2\frac{1}{2}$ " Flanged Plate has been used as the base of the carriage carrying the bottle that is to be agitated, but the actual size of the carriage, will of course, be governed by the size of the bottle or flask. To the Flanged Plate four Trunnions are attached to form journals for two  $3\frac{1}{2}$ " Axle Rods carrying

the four Flanged Wheels, and to either side of the Plate a  $5\frac{1}{2}$ " Braced Girder is fastened, while the front of the carriage is enclosed by two Corner Brackets. In this way the bottle will be held quite securely even when the carriage is oscillated at a good speed.

The oscillating mechanism (see Fig. 3) consists of a  $5\frac{1}{2}$ " Strip

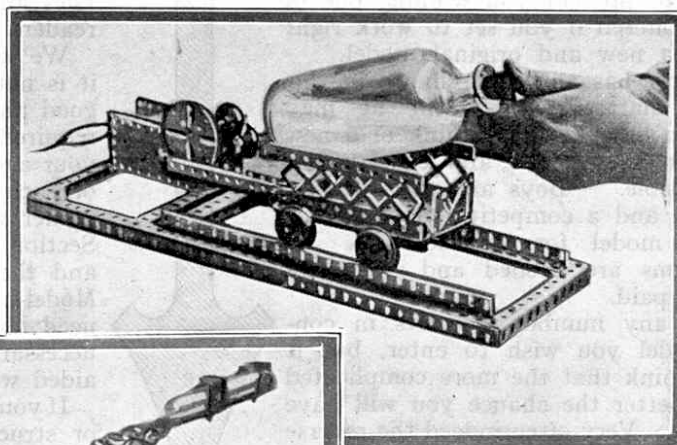
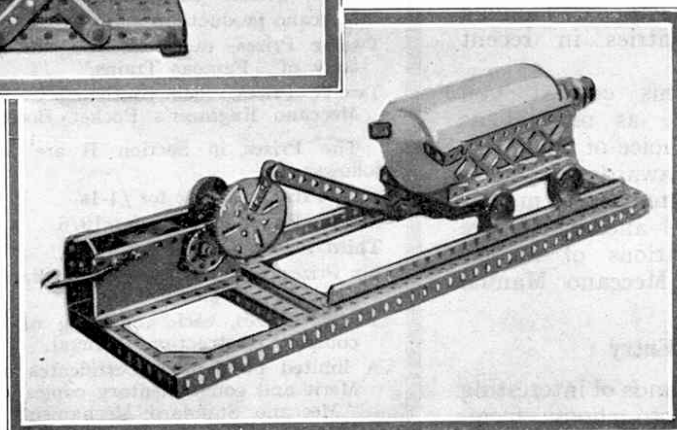
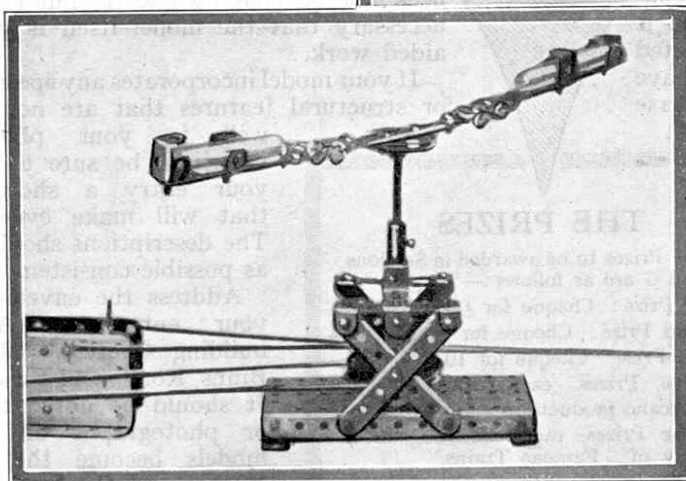

Fig. 1 (Above): Bottle Shaker with bottle in place. Fig. 2 (left): The Meccano Centrifuge in action. The test-tube holders have risen into a horizontal position owing to centrifugal force. Fig. 3 (below): Another view of the Bottle Shaker showing the oscillating gear.



pivotaly secured to a Single Bent Strip that in turn is fastened to the carriage. At its other end the Strip is secured by the means of a bolt and two lock-nuts to a  $2\frac{1}{2}$ " Strip bolted to a Face Plate, which is driven from the Electric Motor through reduction gearing consisting of two 57-teeth Gear Wheels and two  $\frac{1}{2}$ " Pinions. Upon setting the Motor in motion the Face Plate is

rotated and alternately pushes and pulls the carriage holding the bottle, so shaking the contents of the latter. The device will be of particular use when it is required to agitate a liquid for prolonged periods, as for example, when it is required to dissolve a substance that is only slightly soluble.

#### The Meccano Centrifuge

Another form of mixing device is the Centrifuge shown in Figs. 2 and 7. Two test tubes are placed in the holders of the apparatus and are then whirled round at high speed and the contents thoroughly mixed. The base of the Centrifuge consists of a  $5\frac{1}{2}$ "  $\times$   $2\frac{1}{2}$ " Flanged Plate over the centre of which is mounted a Double Bent

Strip on a framework consisting of  $2\frac{1}{2}$ " Double Angle Strips and ordinary Strips. The Double Bent Strip forms a reinforced journal bearing for a vertical Axle Rod that carries a Bush Wheel at its upper end and a 3" Pulley near its lower end.

The holders for the test tubes consist of  $5\frac{1}{2}$ " Strips to which are bolted Angle Brackets. At one end of each Strip a Double Bracket is secured, whilst a 1" Triangular Plate is fastened to the other extremity. To the Bush Wheel that is secured to the vertical Axle

Rod a  $3\frac{1}{2}$ " Strip is bolted, and a 1" Triangular Plate is fastened to each end of this Strip. Each holder is coupled to the  $3\frac{1}{2}$ " Strip by means of two Hooks that are slipped into the holes of the Triangular Plates. This method of connection enables the holders to move freely and swing out by centrifugal force when the vertical Axle Rod is rotated sufficiently fast.

The Centrifuge is set in motion by means of the Electric Motor that can be seen mounted upon the table in Fig. 7. There are many methods of coupling the armature shaft to the 3" Pulley, but the one shown is perhaps the simplest, the cord being passed round the 3" Pulley and over a  $\frac{1}{2}$ " fast Pulley on the armature shaft.

#### Test-Tube and Beaker Shakers

In Fig. 4 will be seen an alternative method of shaking the contents of test tubes. The method of constructing the base and oscillating mechanism is identical to that employed in the Bottle Shaker shown in Fig. 1. Hence it is easily possible to assemble the frame with Electric Motor and oscillating gear and use either the bottle carriage or test tube holder as occasion demands.

The test-tube holder consists of a framework of Strips that is pivoted on two short Axle Rods journalled in two  $9\frac{1}{2}$ " upright Angle Girders. The test tubes are held in partitions constructed from stiff cardboard and are entirely surrounded by a strip of cardboard. When the Face Plate is rotated by the Electric Motor the connecting arm is drawn backwards and forwards and the holder containing the test tubes is rocked gently to and fro.

A further mixing device is shown in Fig. 5. In this case the oscillating mechanism previously described is employed to rotate a 6" Circular Plate, which acts as a table on which is placed a beaker filled with liquid. A Bush Wheel is first secured to the centre of the Circular Plate and a 3" Axle Rod slipped into its boss, a Collar being fastened to the Rod immediately below the Bush Wheel, so that the latter may rotate freely. The lower end of the Rod is secured in the boss of a second Bush Wheel bolted to a  $5\frac{1}{2}$ " Angle Girder forming one of the ends of the base frame.

The Circular Plate is connected to the Face Plate by means of a specially shaped link built up as follows. A  $1" \times \frac{1}{2}"$  Angle Bracket is first attached pivotally, by a bolt and two nuts, to one of the radial holes in the Circular Plate and to this is attached a  $4\frac{1}{2}"$  Strip by means of a bolt and two nuts. To the other end of the  $4\frac{1}{2}"$  Strip a Simple Bell Crank is bolted, and to the latter is

secured a  $3\frac{1}{2}"$  Strip, one end of which is pivoted to the Face Plate.

In order to support the beaker on the Circular Plate four  $3\frac{1}{2}" \times 1\frac{1}{2}"$  Double Angle Strips are secured to the Plate in such a position that the "lip" of the beaker just rests on their angle portions. As a precautionary measure, a rubber band or length of cord should be passed round the Angle Strips near the top so as to prevent the lip of the beaker slipping out of position. When the oscillating mechanism is set in motion the Plate carrying the beaker is given a backward and forward motion through a portion of a circle, and in this way any fluid that is placed in the beaker will be thoroughly mixed.

The remaining illustration represents a Meccano test-tube rack (see Fig. 6). This is certainly the simplest of all the apparatus illustrated, but at the same time its usefulness is unbounded, and it certainly constitutes a great improvement on the wooden racks, which are very difficult to keep clean. The rack shown in Fig. 6, is of course, only representative of this type of laboratory apparatus, and racks of any size and shape can be made to suit the experimenter's requirements.

The stand illustrated is  $5\frac{1}{2}"$  long and is capable of holding three large diameter test tubes and five small size tubes. The tray on which the test tubes rest, comprises a  $5\frac{1}{2}" \times 2\frac{1}{2}"$  Flanged Plate, placed with its flanges upward, and to this is bolted the back and front of the rack. Four Angle Brackets are secured to the top Strip forming the front of the rack, and Flat Brackets are secured to these. Two Flat

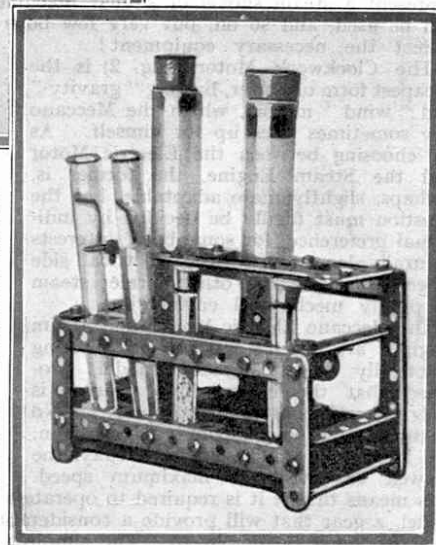
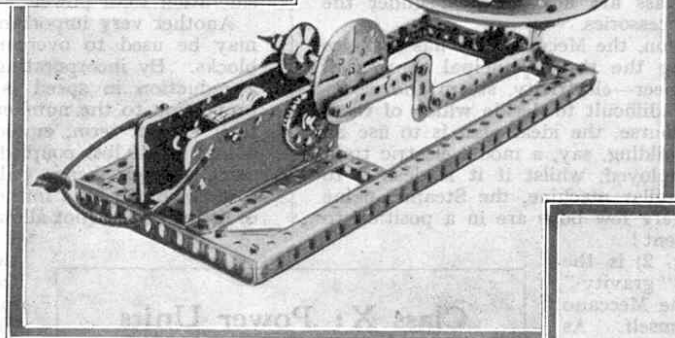
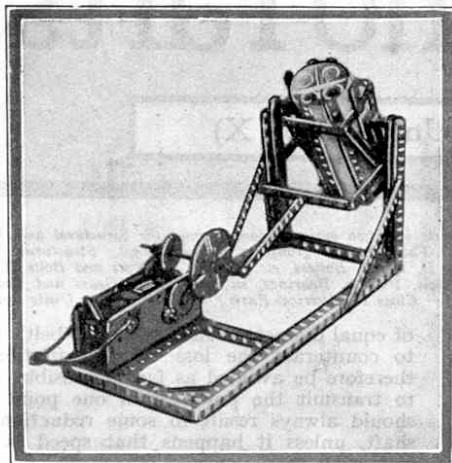

Fig. 4 (top left): An efficient test-tube shaking device. Fig. 5 (above): Apparatus for agitating the contents of a beaker. (It will be seen that this is an adaption of the Bottle Shaking Device shown in Fig. 1). Fig. 6 (right): An example of test-tube rack construction in Meccano.

Brackets are secured in a similar manner to the back, and the complete rack is thus divided into eight separate compartments.

#### Test Tube Tweezers

The model just dealt with forms a solution to the problem of storing test tubes, but an equally troublesome task is that of holding the tubes securely when they are being heated over the Bunsen or spirit lamp. Meccano again comes to the rescue however, as a really efficient pair of test tube tweezers may be constructed from standard parts.

For the arms of the tweezers two  $9\frac{1}{2}"$  Strips should be used, and these should be firmly bolted together at one end. If it is required to insulate the hand entirely from the heat of the Bunsen, the Strips should also be secured to a piece of wood that may be held in the hand, but this addition is not essential. The free ends of the Strips should be slightly curved so that they will fit round the test tubes and grip them securely.

In use, the tube is placed between the Strips, and a Single Bent Strip is placed over the Strips at the end furthest from the test tube, and is then gradually pushed forward, until the curved ends of the Strips are brought into close contact with the outer walls of the test tube, thus gripping it securely.

Every young experimenter who has experienced the unpleasantness of burnt fingers and broken test tubes through lack of a holder, will agree that although the simplest, these tweezers form one of the most useful examples of the Meccano 'Aids to Better Chemistry.'

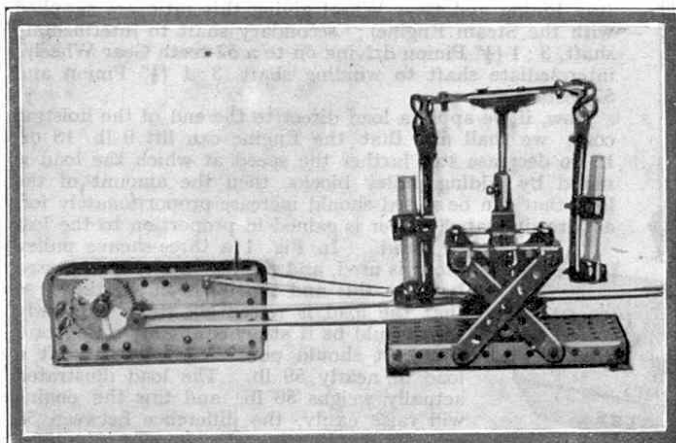

Fig. 7. Another view of the Meccano Centrifuge; mechanism at rest.



# Scientific Apparatus in Meccano

## Laboratory Accessories Constructed from Standard Parts

*This article is the fifth of a series in which we describe various uses that have been found for Meccano in the field of science. In previous articles we have described an instrument for electrocuting small aquatic animals (see "M.M." for November, 1928); a photo-micrographic device and a microscopic slide projector (January, 1929); and a microtome for cutting sections of plant and animal tissue (February, 1929). In the fourth article in the series we dealt with various apparatus for use in chemical experimental work, and this month we describe several additional pieces of equipment for the chemist.*

### V.—FURTHER USEFUL EQUIPMENT FOR THE AMATEUR CHEMIST

IN the previous article in this series, in the April 1930 "M.M.", we described a number of mechanical appliances constructed from Meccano parts, for use in the chemist's laboratory. These included a bottle-shaking device, apparatus for agitating the contents of a beaker, test-tube shakers, and several other articles of use to the chemical experimenter. This month we describe further devices for use in the laboratory, including a tripod, a vertical holder for test-tubes, etc., and a motor-driven stirrer that will be found useful on occasions when it is necessary to keep the contents of a flask or beaker in continual motion for a considerable period.

#### A Meccano Tripod

A tripod stand is a simple but important piece of laboratory equipment. A tripod is used for supporting a beaker, flask or other vessel in such a manner that heat from a Bunsen burner or spirit lamp may be applied to it from below. Stands of this type may be purchased cheaply, but sometimes several are required for a single experiment, and often it is uneconomical to purchase the number required, as most of them will be of little use subsequently to the experimenter. Excellent tripods can be built up as required from standard Meccano parts, and thus the problem may be solved most satisfactorily, the stands that are not required afterwards being dismantled and the parts used again for other purposes.

A simple pattern of tripod constructed from Meccano parts is shown in Fig. 1. The triangular frame of the stand consists of three  $4\frac{1}{2}$ " Strips, and six Cranks are bolted to these as shown in the illustration. The legs of the stand consist of  $6\frac{1}{2}$ " Axle Rods, and these are pushed into the bosses of the Cranks and nipped securely by the Set-screws of the latter. The stand shown in Fig. 1 is a good average size that will be found generally suitable. One of the great advantages of building these stands from Meccano, however, is that different sizes and patterns can be built up by using additional parts.

The experimenter can thus devise stands that will be specially adapted to his own particular requirements.

#### Vertical Holder

A vertical holder for test-tubes, lengths of glass tubing, etc., will be found very useful in the laboratory, and a holder of this type constructed from Meccano parts is shown in Fig. 2.

The base of the holder consists of a  $5\frac{1}{2}$ "  $\times$   $2\frac{1}{2}$ " Flanged Plate, to which four  $12\frac{1}{2}$ " Strips are secured. These Strips support a frame composed of two  $12\frac{1}{2}$ " Angle Girders spaced apart at top and bottom by  $1\frac{1}{2}$ " Strips. A sliding carriage is mounted on this frame. This carriage consists of a  $3\frac{1}{2}$ " Strip having two  $1\frac{1}{2}$ " Strips secured at each end, the  $1\frac{1}{2}$ " Strips being placed on either side of the flanges of the  $12\frac{1}{2}$ " Girders so that the carriage is retained in position in the frame, while capable of being moved up and down when

the holder is required to be adjusted. The carriage is normally held in position by means of a bolt passed through the perforations in one pair of  $1\frac{1}{2}$ " Strips, and through the flange of one of the vertical Angle Girders.

A Double Bracket is secured to the sliding carriage and two  $4\frac{1}{2}$ " Strips are attached to the Bracket, so that they form an arm in which the test tube may be gripped. This arm is held in a horizontal position by means of a strut consisting of a  $3\frac{1}{2}$ " Strip attached to the lower part of the carriage by means of an Angle Bracket. Angle Brackets should be bolted to the free end of the horizontal arm so that a test-tube may be held securely in position.

#### Mechanical Stirrer

Every amateur chemist who has experienced the tedium of stirring liquids

by hand for long periods, will welcome the mechanical stirrer shown in Fig. 3.

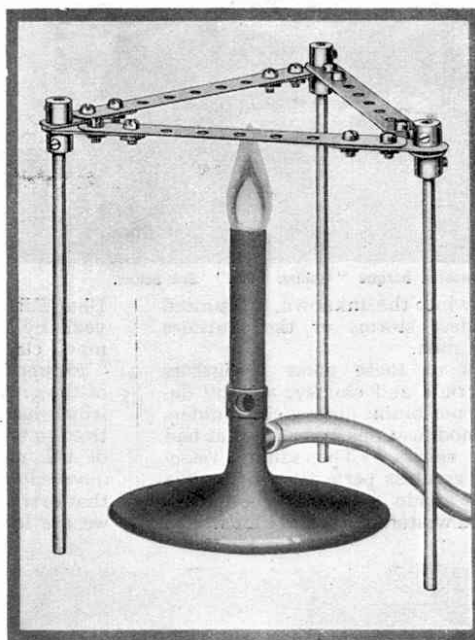
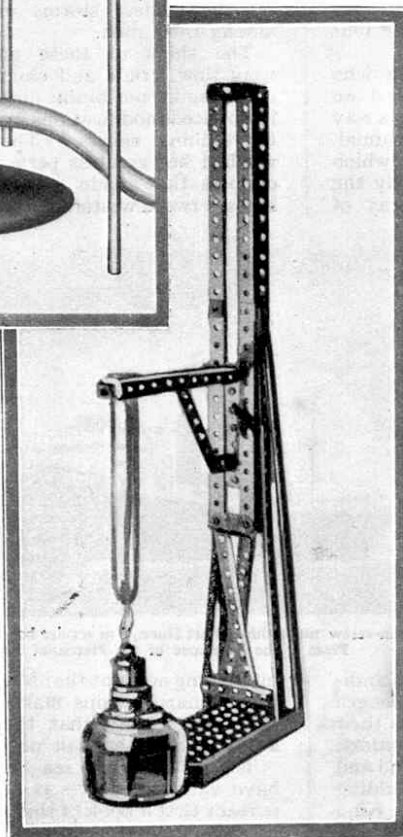

Fig. 1 (above). The Meccano tripod stand used in conjunction with a Bunsen burner. Fig. 2 (right). A useful vertical holder for test-tubes, etc.



The device consists of a combined stand and motor-driven stirrer, that enables the contents of a beaker or similar vessel to be agitated continuously and at uniform speed merely by switching on the Meccano Electric Motor. The base frame of the model is built up from two  $5\frac{1}{2}$ " and two  $12\frac{1}{2}$ " Angle Girders, and two  $5\frac{1}{2} \times 3\frac{1}{2}$ " Flat Plates are secured to these Girders to form a platform on which a spirit lamp or Bunsen burner may rest. The upright frame consists of two  $24\frac{1}{2}$ " Angle Girders spaced apart at top and bottom by  $5\frac{1}{2}$ " Angle Girders, the lower  $5\frac{1}{2}$ " Girders being bolted to the base framework. The upright frame is braced by means of two  $12\frac{1}{2}$ " Strips, the lower ends of which are attached to the base.

A platform for supporting the beaker is next attached to the upright frame. This platform is composed of four  $5\frac{1}{2}$ " Angle Girders, which form a rectangular frame; and two additional  $5\frac{1}{2}$ " Girders are secured between them to form a "grid" on which a beaker or other vessel may be placed. The open construction of the platform enables heat to be applied to the vessel from below. The platform should be braced to the vertical frame by means of Strips.

In the illustration, a glass preserve jar, fitted with screw lid, has been used to hold the liquid to be stirred. This type of jar is excellent for the purpose, providing that a waxed cardboard cap washer is used so that the liquid being stirred does not come into contact with the metal of the lid. A hole must of course be bored in the metal lid, so that the stirrer rod may be passed through into the jar. A beaker or wide-mouthed flask can of course be employed equally well with the device, but care should be taken to see that the stirrer does not run too fast, or a certain amount of liquid will be lost through splashing. A Meccano Electric Motor supplies the power for the stirrer, and it should be secured by means of its flanges to the top of the vertical frame. In

the model a Meccano No. 6 type Motor has been used, but a No. E1 Motor could be employed if slight modifications are made.

The stirrer unit consists of a glass rod, about  $3/16$ " diameter, bent backward and forward in zig-zag formation at one end to form the actual stirrer. The bending process can be carried out by heating the glass rod in a Bunsen flame, and forming the plastic glass to the required shape with fine-nosed pliers.

The straight portion of the glass rod is secured in the bore of a Coupling and an Axle Rod is also held in the Coupling. The Axle Rod is passed through the end holes of two short Strips that are attached to the side Girders of the vertical frame to act as a guide for the stirrer rod.

The upper end of the Axle Rod is connected to the armature shaft of the Electric Motor by a novel form of drive transmission. This consists of a length of  $1/4$ " rubber tubing, one end of which is pushed over a Coupling mounted on the armature shaft while the other end is slipped over the boss of a 2" Pulley attached to the top end of the Axle Rod. The 2" Pulley acts as a flywheel and helps to keep the speed of the stirrer constant. This system of drive transmission greatly increases the adaptability of the device, as the stirring rod can be driven freely even when it is not in alignment with the armature shaft. The lower bearing should consequently be made adjustable so that the stirrer can be used in various positions.

The flexible drive is also useful when open-mouthed vessels, such as beakers, are employed, as it enables the complete stirrer unit to be drawn out of the beaker so that the latter may be removed from the platform. This movement is shown in Fig. 3, but of course it is necessary to disconnect the glass rod from the Coupling when a covered vessel is employed.

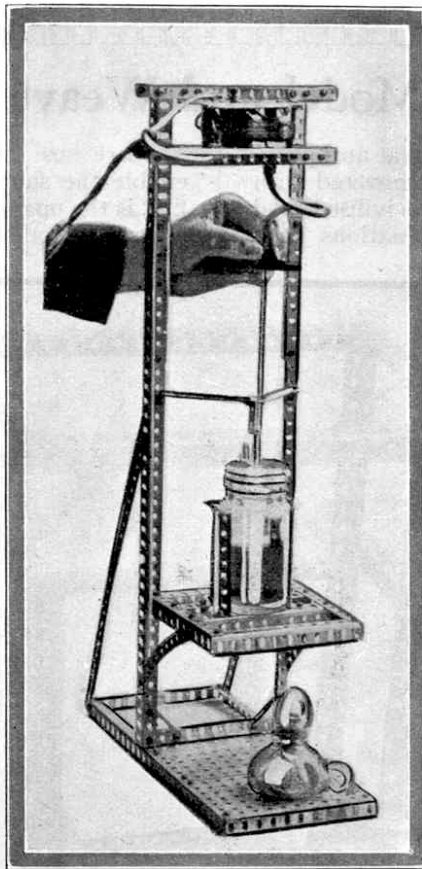

Fig. 3. Meccano mechanical stirrer and beaker stand.

#### New Meccano Models—(Continued from page 213)

is supported at its upper end in the centre hole of a  $2\frac{1}{2} \times \frac{1}{2}$ " Double Angle Strip, while its lower portion passes through the  $5\frac{1}{2} \times 2\frac{1}{2}$ " Flanged Plate. One end of a length of cord is secured to one end of the  $2\frac{1}{2}$ " Strip of the front road axle assembly, and the cord is then passed several times round the projecting end of the steering rod. The remaining end of the cord is finally tied to the other extremity of the  $2\frac{1}{2}$ " Double Angle Strip. A Spring Clip should be placed on the end of the steering column in order to keep the cord in position, while a Bush Wheel is mounted on the upper end to form the steering wheel. A 1" Fast Pulley is mounted on the driving Spindle of the Clockwork Motor and is connected to one of the 3" Pulleys that form the rear road wheels by means of an endless length of cord.

The sides of the trailer are composed of  $12\frac{1}{2}$ " and  $5\frac{1}{2}$ " Braced Girders. A  $12\frac{1}{2}$ " Angle Girder is secured to each of the  $12\frac{1}{2}$ " Braced Girders and a sheet of thick card-

board is bolted to the flanges of the Girders to form the base of the trailer. The front pair of road wheels is mounted on an Axle Rod supported in  $1 \times 1$ " Angle Brackets that are bolted to the cardboard base. The trailer is coupled to the tractor by means of two  $5\frac{1}{2}$ " Strips held to the trailer by Angle Brackets. The  $5\frac{1}{2}$ " Strips are held to the  $5\frac{1}{2} \times 2\frac{1}{2}$ " Flanged Plate of the tractor by means of a lock-nutted bolt.

The rear road axle is mounted in Trunnions which are also secured to the cardboard base by means of bolts. The tractor and trailer contain the following parts:— 8 of No. 2; 2 of No. 3; 12 of No. 5; 2 of No. 8; 4 of No. 10; 2 of No. 11; 10 of No. 12; 2 of No. 12a; 2 of No. 15; 1 of No. 15a; 4 of No. 16; 1 of No. 18a; 2 of No. 19b; 4 of No. 20b; 2 of No. 22; 2 of No. 22a; 1 of No. 24; 7 of No. 35; 60 of No. 37; 6 of No. 37a; 7 of No. 38; 1 of No. 40; 1 of No. 45; 8 of No. 48a; 1 of No. 52; 1 of No. 54; 1 of No. 57; 1 of No. 62; 2 of No. 99; 2 of No. 100; 6 of No. 111c; 4 of No. 125; 2 of No. 126; 2 of No. 126a; 1 No. 1 Clockwork Motor.

#### Model Railway Club Exhibition

The annual exhibition of the Model Railway Club will be held in the Central Hall, Westminster, from Tuesday, 29th March, to Saturday, 2nd April, both days inclusive. This exhibition, which was so keenly appreciated by some 6,000 people last year, will fully maintain its high standard of models of all gauges, from the smallest electric railway to the passenger-carrying steam train that provides such joy to old and young alike. There will be delicate coachwork models, many and varied types of locomotives, and elaborate working layouts completely signalled and controlled from their own signal cabins, and all lighted electrically. We strongly advise all readers who are able to visit this exhibition, for they are certain to find there much that will interest them.

#### For Sutton (Surrey) Readers

An interesting Model-building Competition was held at Sutton, Surrey, recently by William Pile Ltd., and the entries were judged by a representative of Meccano Ltd. The first prize in the class for boys from five to eight years was won by G. Rowley with an excellent model of a Paddle Boat, and the second prize by M. Parker with a model of a Crane. In the class for boys of from nine to 12 years, A. P. Smallman carried off first prize with a well-designed model Stiff-Leg Derrick, and E. P. Gawne obtained second prize for a Motor Car. In the senior section, 13 to 15 years, first prize was awarded to J. C. Bulstrode for an interesting Travelling Crane, and A. C. Greene gained second prize for a good model of a Traction Engine.