

(‘Cathedral Clock’)

SKELETON HIPPI CLOCK

By Dr. Keith Cameron.

THE Hipp Clock was invented by M. Hipp of Neuchatel in 1842. It is powered by a pendulum, the lower end of which has a soft iron armature which swings over an electromagnet providing the impulse. Near the midpoint of the pendulum a V-shaped trigger pivoted, riding over a notched raised section on a contact spring. When the pendulum has full swing, the trigger rides clear of the notch; when the swing shortens, the trigger catches in the notch, pushing the contact spring down, closing contact, and energising the magnet coils. The impulse gives the necessary pull to the armature and when it rides clear of the magnets, the trigger has passed from the notch thus breaking the circuit, and preventing any braking action by the electromagnet. See Diagram A.

A very compact Hipp Clock constructed in Meccano was described in the Meccano Magazine for January 1969 and in ‘Model Building in Meccano’ pages 124-127. The model to be described, however, incorporates several important modifications. Instead of a ‘dimple plate’ as originally described by Hipp and used in the 1969 model, a wedge piece is used and is located to one side of the neutral position of the pendulum, providing a more positive action. TWO contact springs are used, being formed in such a manner as to allow slight rubbing action at the contact points for a self-cleaning effect.

Instead of transferring the action direct to the ratchet through a spring, a gravity arm is used as in commercial clocks. However, the gravity arm is of new design, being inverted from its usual position to allow accurate running without need for critical levelling of the clock case. The clock is housed in an open frame to suggest the skeleton clock of the nineteenth century. No plates are used except in the base. Front and rear sections are held together by Plastic Rods and Screwed Rods to maintain open construction. A seconds hand is included.

BASE Figures 6, 7, 10

This measures 16½" wide by 9½" deep and is 2½" high. It is edged throughout by Angle Girders and Strips, composite ones being used for the long dimension. Sides and top are filled in with Strip Plates and Flexible Plates as shown and the top is strengthened on its under surface by four additional 9½" Angle Girders fixed from back to front. A space 2" x 1½" is left at the location shown for the electromagnets to protrude. A pair of 12½" Angle Girders are bolted to the upper surface of the base by their slotted holes. Between them a pair of 4½" Angle Girders 2 are fixed, also by their slotted holes.

THE ELECTROMAGNET Figures 7, 8, 9

Two pairs of Cylindrical Coils are used, each pair connected by Bolts through their terminal eyelets. Follow Diagram B in making the connections. Each pair of Coils is bolted to the 1½" x 1½" Flat Plate as shown, the Bolts securing one set of Coils also fixing a 1½" Angle Girder 3 in place. The Bolts are screwed down through the threaded section of the base of the Coils, hand-tightened, and then passed through the Flat Plate and fixed firmly with Nuts. This is preferable to the practice of passing the Bolt up into the threaded section. Two pairs of Cores for Cylindrical Coils are lock-nutted together

on 2" Screwed Rods, about ½" of the Rod being allowed to protrude.

These assemblies are now passed into the Coils, about five Washers added for spacing, and through the corresponding holes in the Flat Plate and 1½" Angle Girder. A yoke of five 1½" Strips 4 and a Fishplate are held on the Rods by Nuts. The Cores should project ¼" above the tops of the Coils. The 1½" Angle Girder 3 is bolted to the bottom row of holes of

a 3" x 1½" Flat Plate 5 which is bolted above to the 12½" Angle Girder 1 and fixed below to two 2½" x ½" DA Strips bolted to the rear of the base.

BODY Figures 2, 4, 10

This consists of two sections, front and rear, almost identical. Slight differences between them will be indicated. They are bolted below

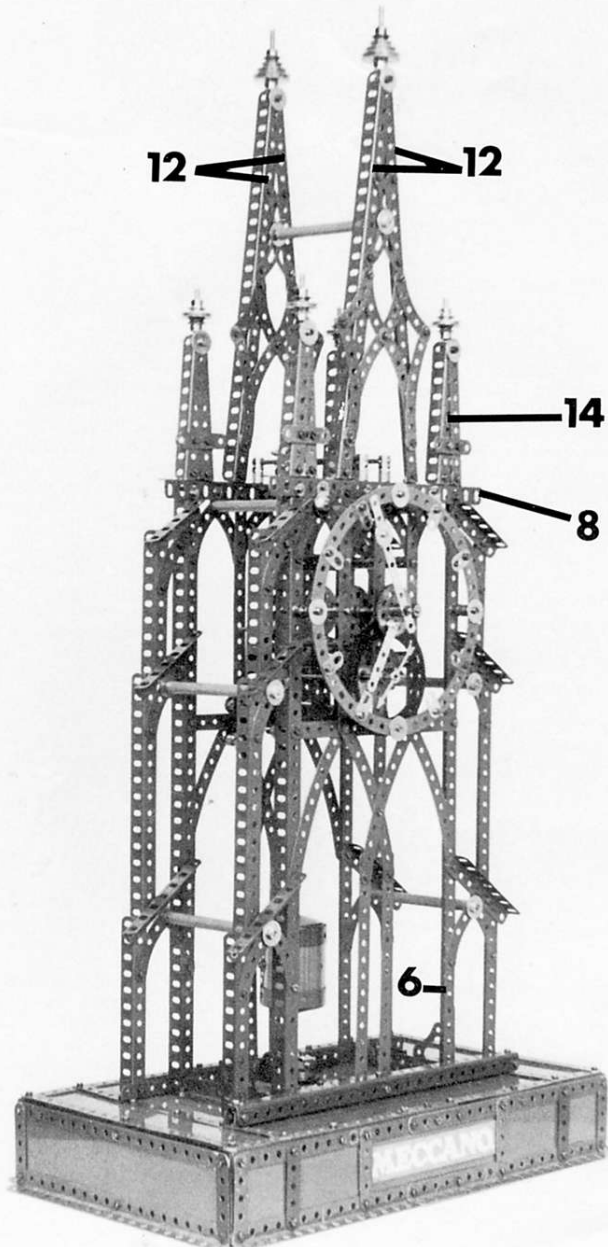

FIG. 1. Forward left hand 3/4 view of the Hipp Clock, designed by Dr. Cameron.

to the rear surfaces of the flanges of the 12 1/2" Angle Girders 1 bolted to the top surface of the base. The main members are 18 1/2" Angle Girders 6 with cross members being 7 1/2" Strips 7 at the 15th hole down, and 9 1/2" Angle Girders 8 at the top holes. Between the main members in the upper section are three vertical 7 1/2" Strips 9 decorated at their upper ends by 2 1/2" Curved Strips which are held to the 9 1/2" Angle Girders 8 by Fishplates.

In the lower section are two vertical 7 1/2" Strips 10 and four 5 1/2" Curved Strips 11. In the rear section, these Strips are spaced to the rear at each point by a Collar to allow space for the pendulum bob. Outside the main members are placed, from below up, 5 1/2", 7 1/2" and 4 1/2" Angle Girders, short sloping girders which are 3 1/2", 3" and 2 1/2" Angle Girders respectively, and each portion is finished by the addition of 2 1/2" Curved Strips as shown. The front 18 1/2" Angle Girders 6 are braced to 4 1/2" Angle Girders 2 by Corner Gussets.

SPIRES Figures 1, 3, 4

The central spire in each case is a pair of 12 1/2" Angle Girders 12, fixed below by Angle Brackets to the 9 1/2" Girders 8. A Bolt and 3/8" Washer secures the top ends by passing into the threaded bore of a Collar which holds a 2 1/2" Rod on which is mounted a finial consisting of a Cone Pulley 13 and a 1/2" Pulley with Boss.

The spire is decorated with pairs of 4", 2 1/2" and 3" Curved Strips as shown. Smaller spires are each made from a pair of 4 1/2" Angle Girders 14 connected below to the 9 1/2" Girder 8 by Angle Brackets, and holding finials above like the main spire, but using two 1/2" Pulleys with a 1" Pulley without Boss between them. 2" Strips decorate these small spires.

MECHANISM FRAME Figures 14, 15

This is fixed to the outer pair of 7 1/2" Strips 9 in the upper part of the front body section using 3" Screwed Rods with three Couplings on each as spacers. The frame consists above and below

FIG. 3: Main view of the front of the Clock, showing the Gothic styling of the frame.

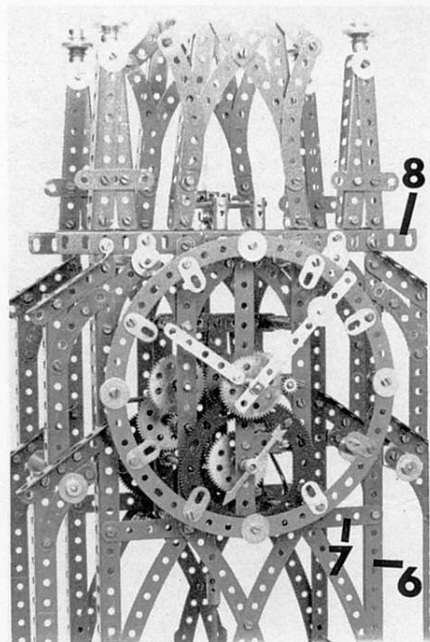
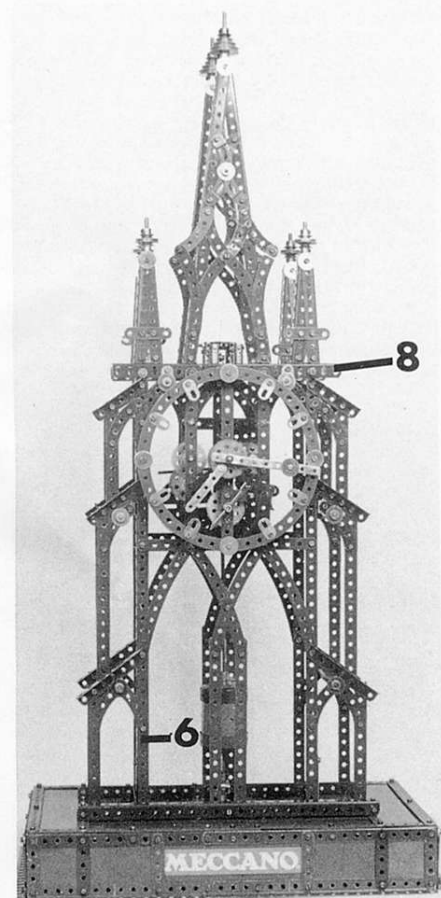

FIG. 2: The Clock dials are shown to advantage in this close-up shot.

of doubled 3 1/2" Strips 15, and attached to these are three sets of vertical 5 1/2" Strips 16, also doubled. Note the uneven spacing. Pivot Bolts (Elektrikit No. 545) are lock-nutted at the places shown, 'x'. A 2" Strip 17 and a 1" Corner Bracket 18 are fixed to the forward 7 1/2" Strips 9.

CONTACT SPRINGS Figure 16

A 7/32" Cheesehead Bolt 19 has its head filed to a wedge as shown in Diagram C. Choose a Bolt with a shallow slot which should be effaced and a new shallow slot filed near the summit.

With this Bolt and Nut connect two 2" Wiper Arms 20, by their end holes. Straighten the bent end of one arm 20 and mount this part between a Fishplate and the long lug of a 1" x 1/2" Angle Bracket 21. Reshape the other Wiper Arm and bolt the Angle Bracket 21, lug upward and behind the horizontal 7 1/2" Strip 7 of the rear body. The free end of this upper contact spring lightly presses against a 3/4" Bolt 22 mounted in a Threaded Boss bolted to the rear body and locked with a Terminal Nut.

A further 2" Wiper Arm 23 reshaped as shown is bolted by its end hole to a Threaded Boss 24 which is held on a 1 1/2" Insulating Strip fixed to the 7 1/2" Strip 7. The upper and lower contact springs are adjusted until their contacts are separated by a 1/32" gap, the upper being vertically above the lower. Bolt two (doubled) 3 1/2" Strips 25 to the vertical 7 1/2" Strips 9 using 1/2" Bolts, spacing them behind the Strips by two Washers and a Collar on each Bolt. Fix a Pivot Bolt in the 3 1/2" Strips 25 as shown at x.

CONNECTING FRONT AND REAR BODY SECTIONS

Below, each section is bolted to a 12 1/2" Angle Girder. Above, the sections are connected by 5" Screwed Rods and 4 1/2" Plastic Rods at seven locations as follows: at the peak of the lowest pair of 2 1/2" Curved Strips; through the hole next to the top of the 2 1/2" Curved Strips connected to the 7 1/2" Angle Girders; through the peak of the pairs of 2 1/2" Curved Strips at the top of the main body just under the 9 1/2" Angle Girders 8; and through the point in the main spire where the central holes of the 3" Curved Strips overlap.

On all of these Screwed Rods, 4 1/2" Plastic Rods are used as spacers, and 3/4" Washers are placed on all surfaces. Terminal Nuts are used

at the front end of the Screwed Rods, being more decorative than ordinary nuts.

PENDULUM SUSPENSION Figures 5, 17

A pair of Threaded Couplings 26 bolted to the flanges of the 9 1/2" Angle Girders 8 support 5" Rods in their upper transverse holes, these Rods also passing through transverse holes of Short Couplings. Through the other transverse holes of these Short Couplings a 2" Screwed Rod 27 is passed; between the Couplings this rod carries a 2" Flexible Strip spaced from each Coupling by a Collar, a Washer, and a Thin Washer, and it is held in place by Hexagonal Nuts. (Square Nuts are obstructed by the Grub Screws in the Couplings.)

PENDULUM Figures 11, 19

From the top down the Pendulum consists of the following: An End Bearing 28, a 3 1/2" Rod carrying a Short Coupling, and connected to a 6 1/2" Rod by a regular Coupling; the 6 1/2" Rod passes through the centre transverse hole of a Threaded Coupling 29 and is connected by a further Threaded Coupling to an 8" Screwed Rod which carries the bob and which is locknutted at its lower end in the boss of a Double Arm Crank 30.

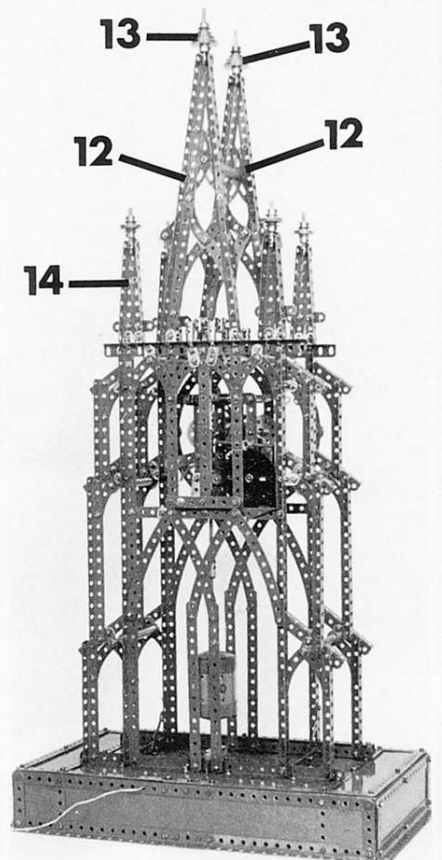

FIG. 4: The Hipp Clock as seen from the rear.

THE BOB

A Cylinder is constructed from a 5 1/2" x 2 1/2" Plastic Plate lengthened 2" by being bolted to a 2 1/2" x 1 1/2" Plastic Plate. Adjust this as a snug fit in a pair of Boiler Ends. Mount all this on the 8" Screwed Rod with a Conical Disc above and below, and also a nut and a Threaded Boss below, and a Threaded Boss above.

Fill the bob with Meccano Bolts till it weighs about one pound. Shot or other weighty matter can be used instead of bolts. Screw the Threaded Bosses together to close the bob to prevent spillage. A Centre Fork held in a Rod and Strip Connector is fixed by a Shoulder Bolt through the connector into the end threaded hole of the Threaded Coupling 29.

PENDULUM MOVEMENT

Complete the wiring as shown in the wiring diagram. The pendulum is suspended by bolting the End Bearing 28 to the 2" Flexible Strip (two holes of which project up unused above the 2" Screwed Rod 27). A 1/2" x 1/2" Angle Bracket is bolted to the end hole of the Double Arm Crank 30 and a Core for Rectangular Coil

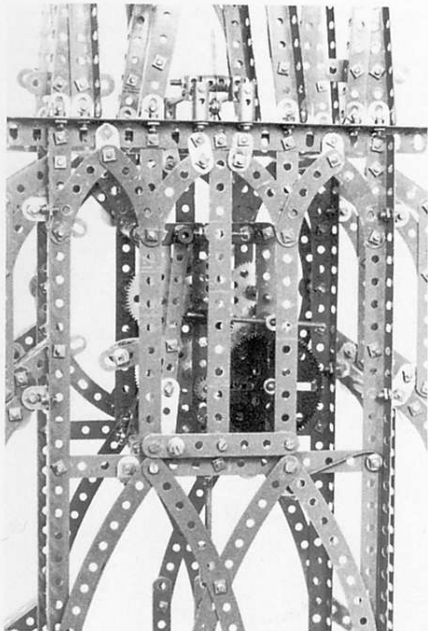

FIG. 5: The rear of the gearbox framework, housed in the upper part of the Clock body.

is bolted by its end threaded hole to the lug of the Angle Bracket thus bringing the Core close to the undersurface of the Crank 30. Adjust the length of the pendulum so this Core clears the Cores of the electromagnets by 1/16".

Adjust the Threaded Coupling 29 till the Centre Fork clears the Contact Strips 20 by about 1/16" but catches on the wedged bolt-head 19 as described in the opening paragraph. Adjust the Short Couplings of the pendulum suspension so that the Centre Fork is centrally placed over the Contact Strips and so that the Core at the lower end sweeps over the electromagnet without hitting the rear part of the body. Connect the coils and contacts to a source of about 9 volts. Set the pendulum in motion. It should keep swinging indefinitely.

GRAVITY ARM Figures 5, 11 18

This is L-shaped, and made from a 5/2" Narrow Strip 31 secured at 90° at its lower end to a 2 1/2" Narrow Strip to which a 1/2" Pulley with Boss 32, is bolted. A Crank secures the 5/2" Narrow Strip to a 2" Pivot Rod 33 journalled in the Pivot Bolt x in the 3 1/2" Strips 25 of the rear frame and in the corresponding Pivot Bolt x on the mechanism frame. Also fixed to the gravity arm are an Insulating Spacer at the top hole and a 2" Slotted Strip at the sixth hole from the top, and set at a slight downward angle.

A 1 1/8" Bolt with a Pawl without Boss 34 held by locknuts at its head end is lock-nutted at about the centre of the slot in the 2" Slotted Strip. A further 2" Pivot Rod 35 carrying a Ratchet Wheel to its rear and a 3/4" Pinion at its front end rotates in the other set of Pivot Bolts x, one of which is held in the 2" Strip 17 of the mechanism frame. The Ratchet Wheel is mounted boss to the front, the Pinion, boss to the rear. The gravity arm rests against a stop made from an Insulating Spacer lock-nutted on a 3" Screwed Rod threaded through the end transverse threaded hole of a Threaded Coupling 36 bolted to the rear of the mechanism frame.

This stop is adjusted by rotating it until the

Insulating Spacer allows the correct range of movement of the gravity arm. The gravity arm is actuated by a 1 1/8" Bolt 37 fixed by locknuts in the transverse unthreaded hole of the Short Coupling near the top of the pendulum. With the pendulum in its neutral position, this Bolt 37 must contact the Insulating Spacer of the gravity arm which should be separated from the stop by about 1/16". Now adjust the 2" Slotted Strip and the Bolt lock-nutted in its slot so that at each swing of the pendulum the Pawl 34 sweeps over one tooth of the Ratchet Wheel.

When the pendulum swings clear of the gravity arm, the latter will return by the weight of the 1/2" Pulley 32 and cause the Ratchet Wheel to advance one tooth. To prevent free-wheeling of the ratchet, a 2" Wiper Arm presses against its axle 35, the wiper arm being fixed to a Fishplate bolted to one of the spacer couplings of the mechanism frame.

Adjust the stop if necessary to provide sufficient movement for the ratchet—and to prevent excessive motion with resulting engagement of two teeth at one swing.

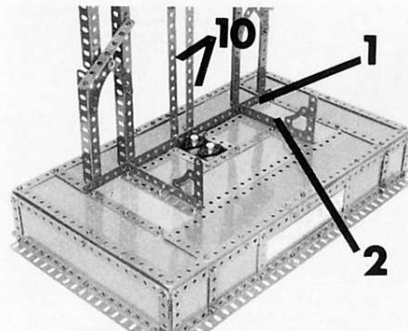

FIG. 6: The base of the Clock prior to fitting the front section of the body.

GEAR TRAIN Figures 12, 13, 14, 15

The 3/4" Pinion on Rod 35 engages a 60-T Gear Wheel on a 4" Rod journalled in the midline of the clock, and 1/2" lower than the ratchet rod 35. To allow for free mesh, the 2" Strip 17 must be adjusted in its bolts to lie as high as possible. This 4" Rod carries from front to rear a Pointer (Obsolete Part No. 156), a Collar and Washer and behind the mechanism a 1/2" Pinion 38 which engages with a 2 1/2" Gear Wheel on a 3 1/2" Rod in the 5 o'clock region.

This rod also carries a 7/16" Pinion (and Washer) which meshes with a 60-T Gear Wheel on a 3" Rod vertically above it, a rod which also carries near its front (but within the frame) a 1/2" Pinion. This Pinion engages a 57-T Gear Wheel on a further 3" Rod vertically above it.

The minute hand is a 4 1/2" Narrow Strip fixed by a nut to the threaded section of a Rod Socket

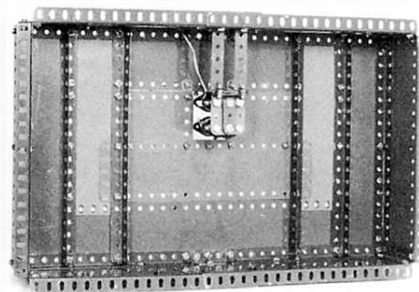

FIG. 7: Underside view of the base, note placement of Elektrikit coils.

mounted on a 4" Rod 40 carrying, from front to rear, a Washer, a 60-T Gear Wheel loose on the shaft, a Collar, a Washer, the centre hole of the central 7 1/2" Strip 9, a Washer, a Collar 39, a

Compression Spring, a 57-T Gear Wheel loose on the shaft but pressed by the spring, against a 1" Pulley with Rubber Ring fixed to the shaft, and finally a 1/2" Pinion in front of the rear strip 16 of the frame. The loose 60-T Gear Wheel has the hour hand fixed to it, a 2 1/2" Narrow Strip spaced with three washers.

The loose 57-T Gear Wheel meshes with its neighbour on the 3 o'clock side. The 1/2" Pinion meshes with a 57-T Gear Wheel on a 3 1/2" Rod journalled in the 1" Corner Bracket 18 and the rear frame and carrying a 7/16" pinion which drives the loose 60T Gear Wheel.

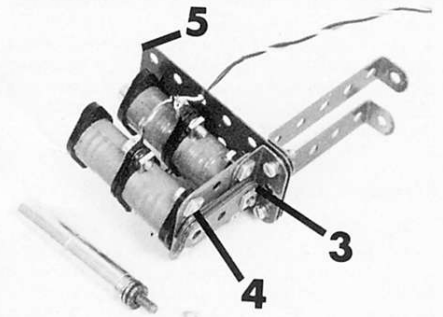

FIG. 8: The built-up electromagnets, with one core removed to show construction.

THE DIALS Figure 2

The seconds dial is a Gear Ring mounted concentrically with the second hand, spaced by a collar above and below. The main dial is a 7 1/2" Circular Strip mounted at 3, 6, 9, and 12 o'clock on 1 1/8" Bolts attached to vertical and horizontal members of the frame, spaced by two Collars on each Bolt. The Bolt at 6 o'clock also secures the seconds dial. These four Bolts hold 3/4" Washers to represent numerals, the other numerals being Fishplates arranged as shown.

Note that the 1 1/8" Bolts pass through the midpoint of the long slotted holes of the Circular Strip. A Circular Strip of a Contrasting colour should be used, and the Narrow Strips making up the hands should also be of a different finish from the body of the clock.

OPERATION

Follow the simple wiring diagram for electrical connections. The ideal power supply is a set of nickel-cadmium batteries connected to a trickle charger. This will obviate stoppage of the clock in the event of a power cut. About 9 volts is ideal. Higher voltages could cause the core at the bottom of the pendulum to touch the core of the electromagnets.

Adjust the pendulum suspension so that the pendulum swings clear of all obstacles, and so that the core at its lower end lines up with the

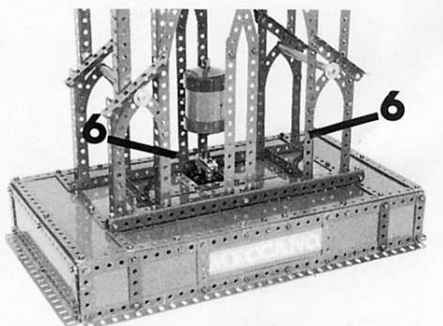

FIG. 10: Close-up view of the completed base.

cores of the electromagnets with a gap of about 1/16". The trigger must also be positioned over the upper contact spring. The gap between the two contacts must be adjusted to close in the

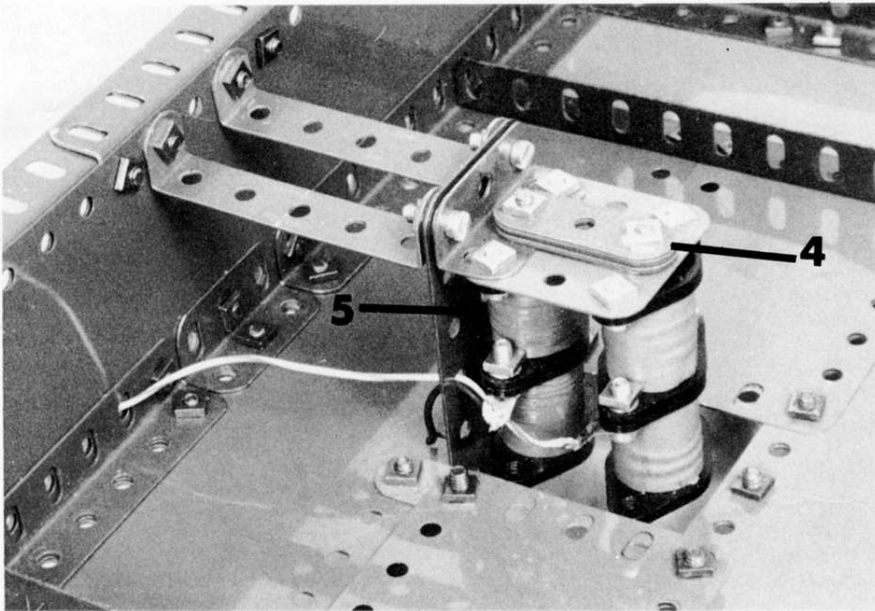

FIG. 9: The electromagnets in position inside the Clock base.

manner described in the introductory paragraph.

When the pendulum is swinging satisfactorily, make sure that the Pawl 34 on the gravity arm rides over a full tooth of the Ratchet. Time-keeping is adjusted by altering the level

of the pendulum bob and this is easily done with the supporting Threaded Boss. This adjustment is made easier because of the provision of the seconds hand, the sweep of which can be checked against that of a commercial mains-operated electric clock.

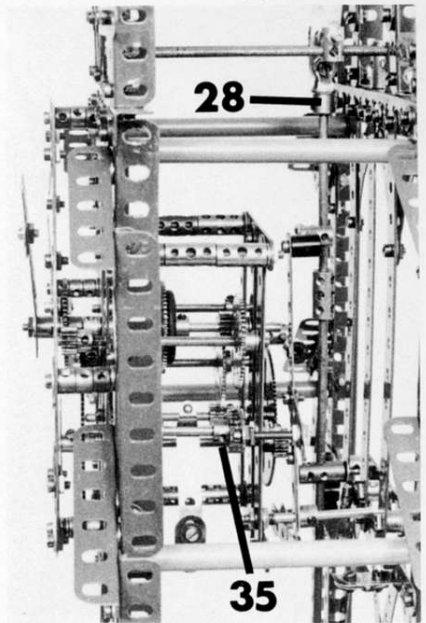

FIG. 11: Clock mechanism as viewed from the '3 o'Clock' position.

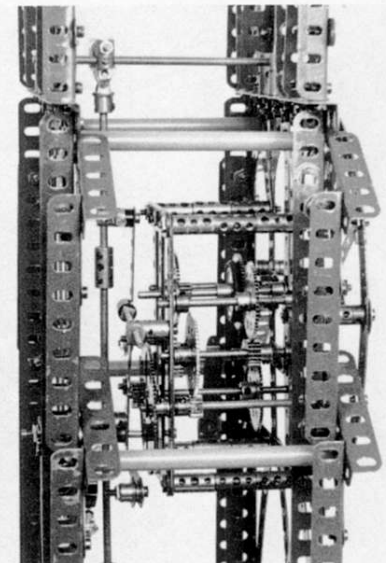
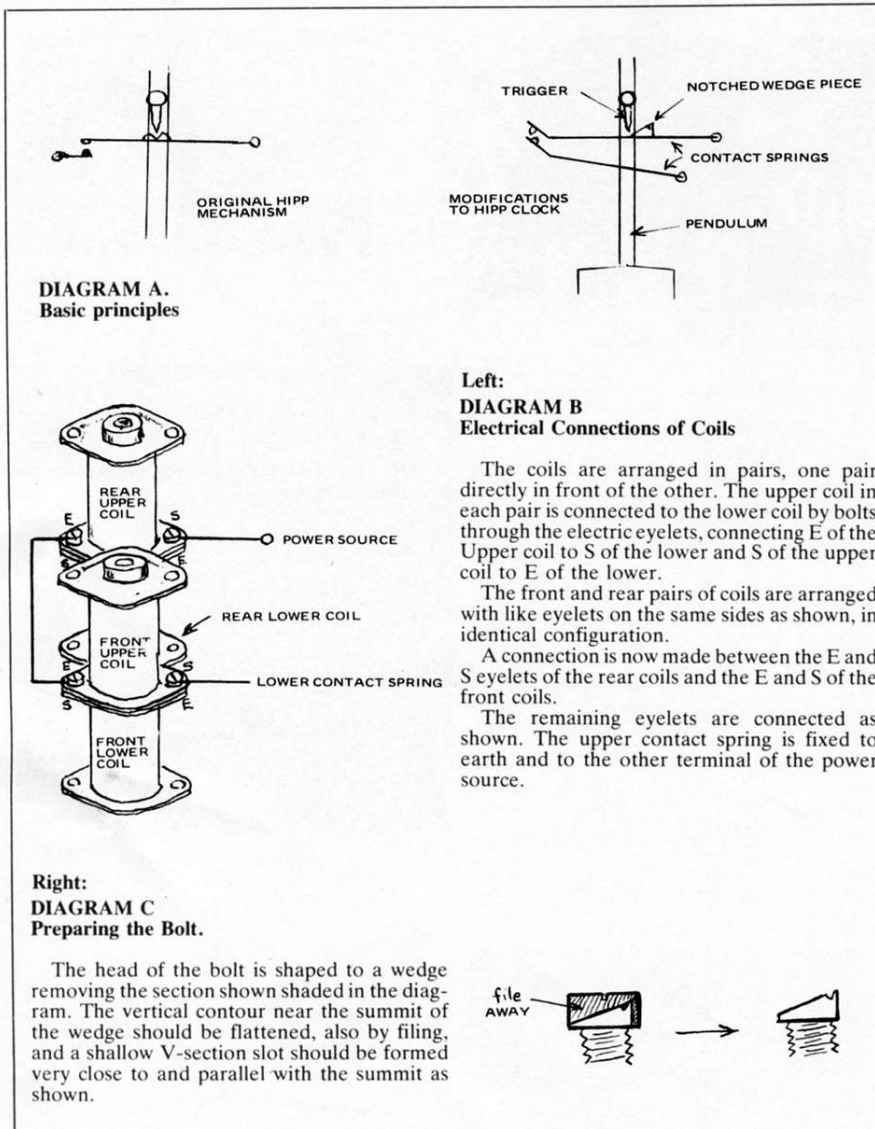

FIG. 12: Clock mechanism as viewed from the '9 o'Clock' position.



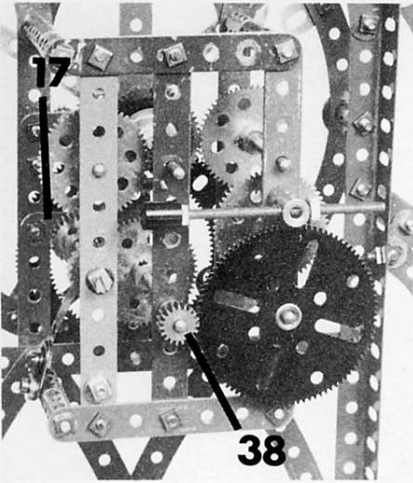

FIG. 13: The mechanism after removal of the rear part of the body.

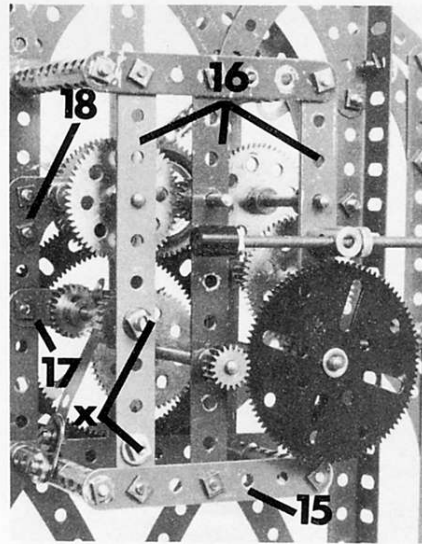

FIG. 14: The 2" Strip 17 requires careful adjustment to insure the best operation.

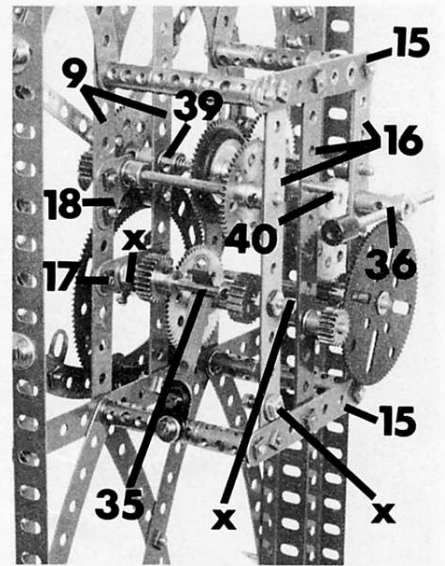

FIG. 15: The gearbox seen from a different rear viewpoint, showing positions of Axle Rods.

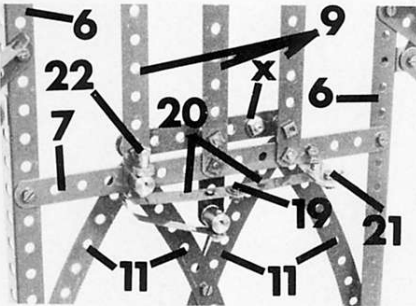

FIG. 16: Contact Strips, with the notched wedge piece 19.

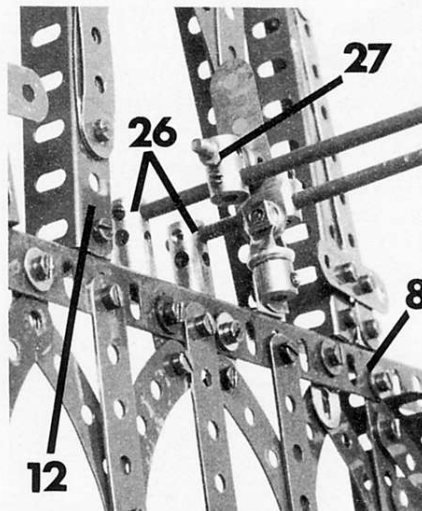

FIG. 17: The pendulum suspension arrangement, after removal of pendulum.

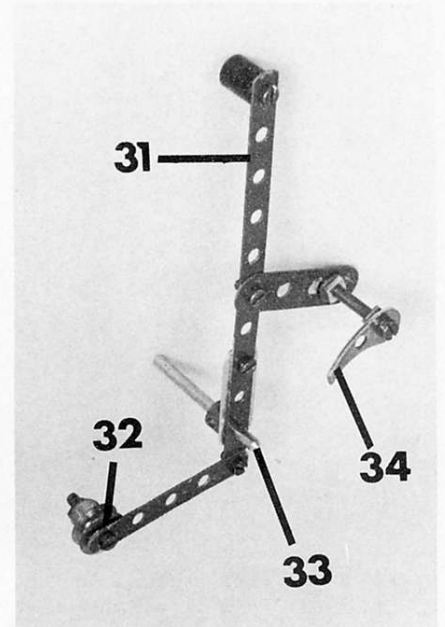

FIG. 18: Removed from the mechanism, the gravity arm.

SKELETON HIPPI CLOCK PARTS REQUIRED

1 of No. 1	340 of No. 37C
12 of No. 1A	130 of No. 38
13 of No. 1B	24 of No. 38D
6 of No. 2	2 of No. 48A
2 of No. 2A	1 of No. 55A
6 of No. 3	34 of No. 59
2 of No. 4	1 of No. 62
16 of No. 5	1 of No. 62B
5 of No. 6	13 of No. 63
7 of No. 6A	7 of No. 63C
4 of No. 7A	3 of No. 63D
7 of No. 8	3 of No. 64
14 of No. 8A	1 of No. 65
8 of No. 8B	1 of No. 73
4 of No. 9	
14 of No. 9A	1 of No. 74
4 of No. 9B	1 of No. 79
4 of No. 9C	5 of No. 80
8 of No. 9D	4 of No. 80C
3 of No. 9F	3 of No. 81
27 of No. 10	8 of No. 89
21 of No. 12	4 of No. 89A
1 of No. 12B	8 of No. 89B
1 of No. 14	36 of No. 90
2 of No. 15	2 of No. 108
2 of No. 15B	3 of No. 111
3 of No. 16	9 of No. 111A
	11 of No. 111C
	9 of No. 111D
2 of No. 16A	1 of No. 120B
2 of No. 16B	2 of No. 123
4 of No. 17	
1 of No. 22	
4 of No. 22A	1 of No. 145
11 of No. 23A	1 of No. 147C
1 of No. 25	1 of No. 148
3 of No. 26	1 of No. 155
2 of No. 26C	1 of No. 162A
3 of No. 27A	1 of No. 166
1 of No. 27C	1 of No. 179
3 of No. 27D	1 of No. 180
300 of No. 37B	2 of No. 187A

4 of No. 190
2 of No. 190A
1 of No. 194
1 of No. 194E
2 of No. 195
5 of No. 196
2 of No. 197
1 of No. 212
2 of No. 235
1 of No. 235D
1 of No. 235F
Replica part:
1 of No. 156
Elektrikit parts
1 of No. 503
4 of No. 522
1 of No. 526
4 of No. 528
1 of No. 530
4 of No. 533
9 of No. 542
4 of No. 545
2 of No. 549
2 of No. 564
2 of No. 561
Plastic Meccano
7 4 1/2" Rods

A 1" Rod filed to a screwdriver point is just as good as a Centre Fork

FIG. 19: The Pendulum is shown here complete, except for the End Bearing 28.

