

TABLE-TOP BLOCK-SETTER

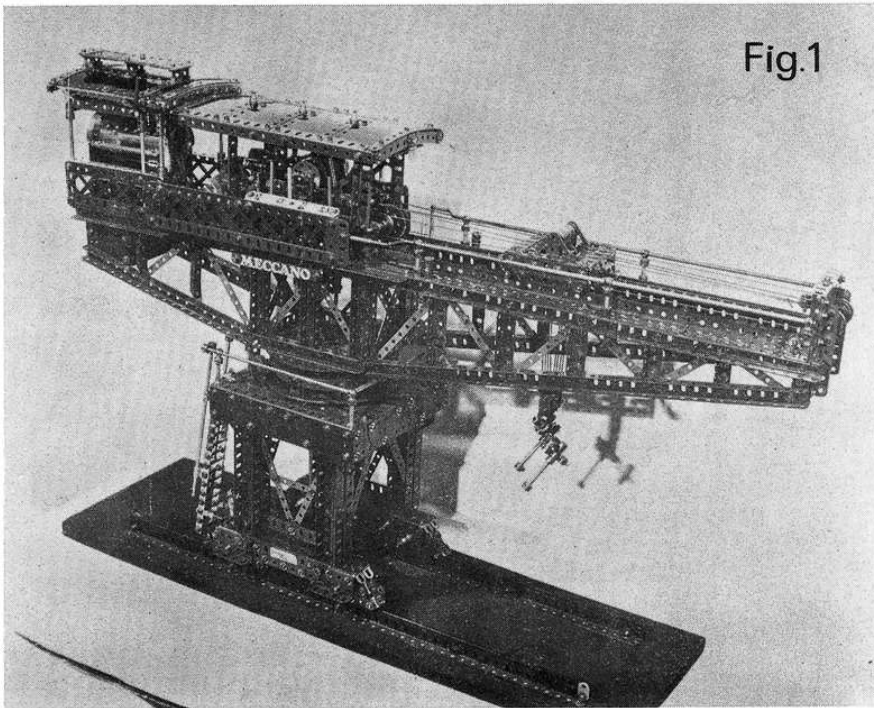

Fig.1

The superb steam-driven Crane with which MICHAEL MARTIN won the Meccano Cup at the 1974 Model Engineer Exhibition.

VISIT ANY Meccano Exhibition and the chances are you will spot at least one Giant Block-setting Crane. In fact, some of them are like old soldiers – they never die and hardly ever fade away!

One of the drawbacks of such giants, however, is the abnormal

amount of space they take up in the home and this is something which MICHAEL MARTIN – MMQ reader and advanced modeller of long-standing – had very much in mind when he settled down to build a new Block-setter of his own. The result was the superb 'table-top' model

illustrated here. The table-top description, however, should not be misunderstood; although smaller than some other Block-setting Cranes that have been built in the past, Michael's version is still a large and advanced model of excellent detail and proportion. Indeed, so good is it that it

Fig. 1 (above), the finished Block-setter by Michael Martin. All motions work from a single Steam Engine. Fig. 2, close-up of gearbox. Fig. 3, mid-section of crane gantry showing the four operating levers.

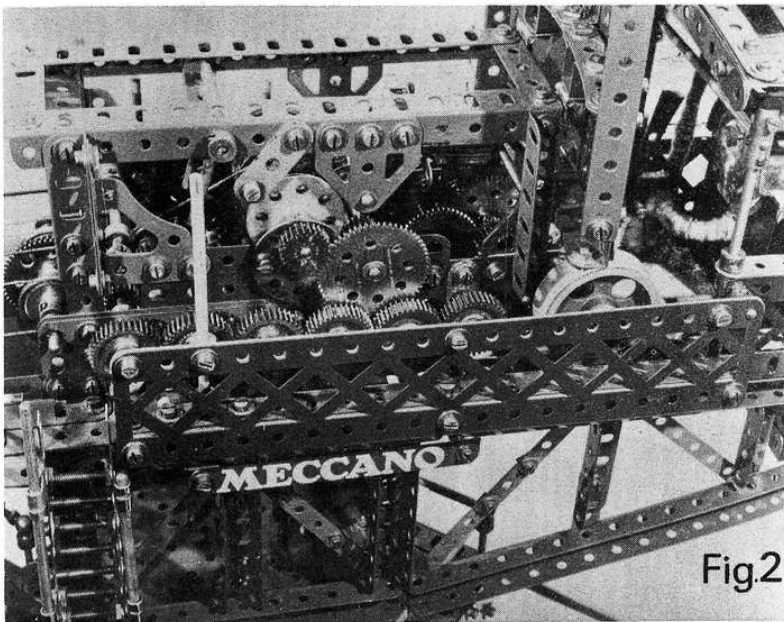

Fig.2

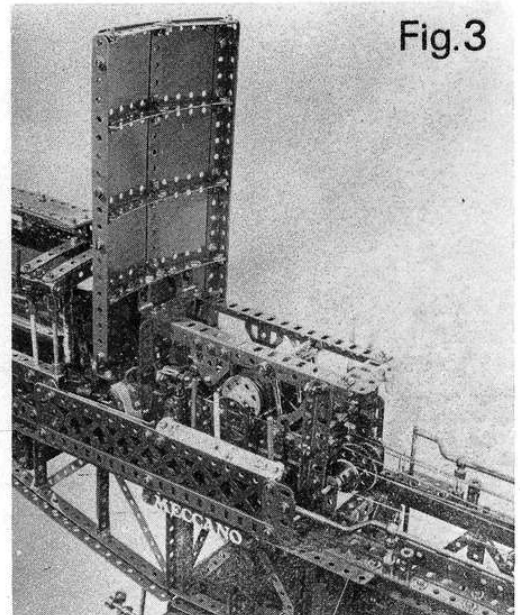

Fig.3

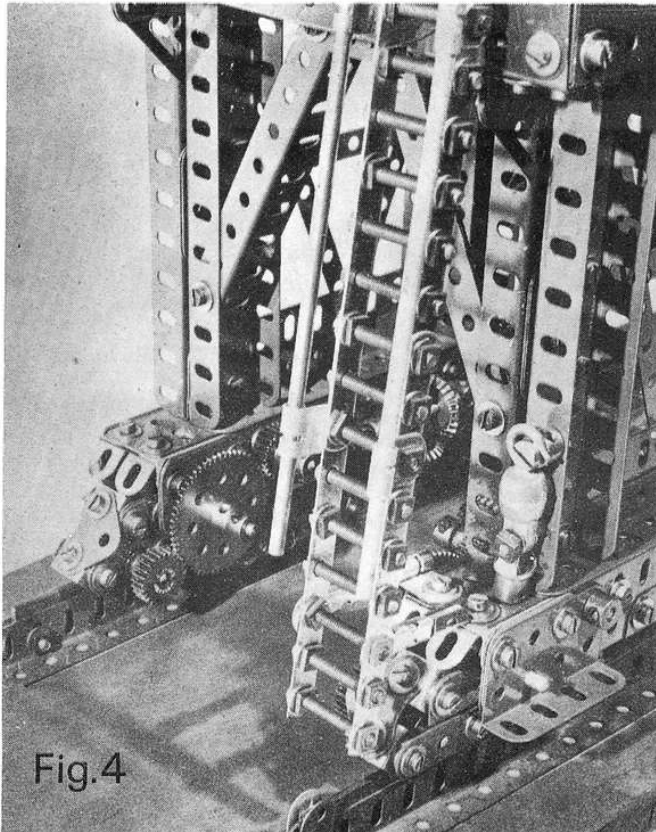

Fig. 4

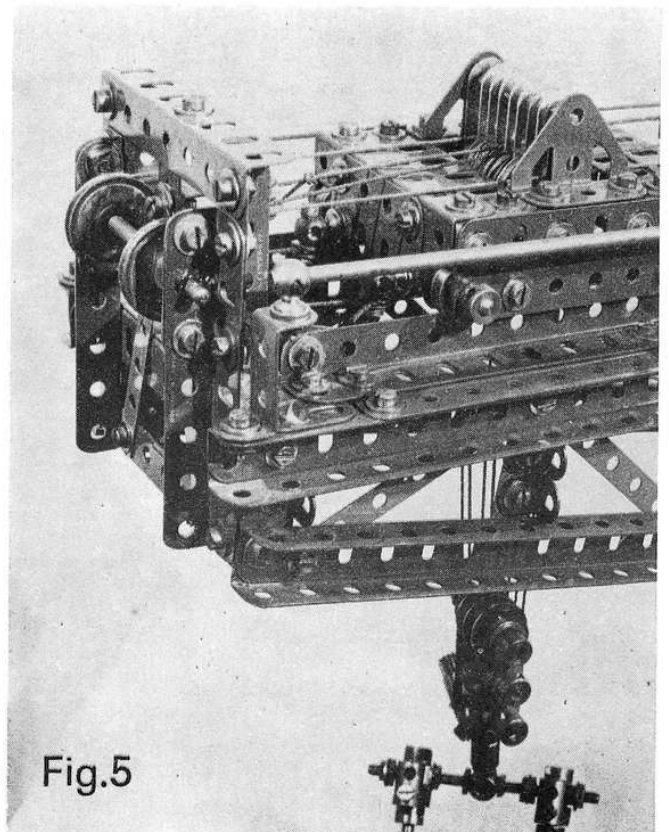

Fig. 5

Fig. 4, close-up of tower base showing details of final spur drive, ladderwork and auxiliary hook stowage. A raised edge rail is used to accommodate $\frac{1}{2}$ " Pulleys used as travelling wheels. Fig. 5, gantry-head details and trolley construction. Hoisting cord from the winding drums is centralised by a $\frac{1}{2}$ " Pulley in the gantry-head after passing through the twin sets of pulley blocks in the trolley and hoisting block. Fig. 6, a ground view of Michael Martin's completed Crane. The turntable has a captive ball race. Note compound bevel, contra and spur gear drive to travelling wheels.

netted the Meccano Cup at the 1974 Model Engineer Exhibition — a well deserved success.

Michael set himself two tasks, one being to keep the model's overall size in bounds, while still producing a fully-detailed and operating model, and the other to make sure that it had all of its motions working properly from one steamplant — just like the original juggernauts which, at the beginning of this Century, heaved into place the massive stone blocks of half the world's harbours. He achieved all of his original aims.

And herein lies the problem. General assembly details of the model have been prepared, but, because of the comprehensive nature of the model, the details are too extensive for inclusion in the magazine, itself. We therefore feature here the photographs of the model — taken by BERT LOVE — and we will supply the building instructions as a separate supplement obtainable from us on request. To obtain a copy, please send an S.A.E. (overseas, two International Reply Coupons) to: Meccano Magazine Quarterly, P.O. Box No. 4, Binns Rd., Liverpool L13 1DA.

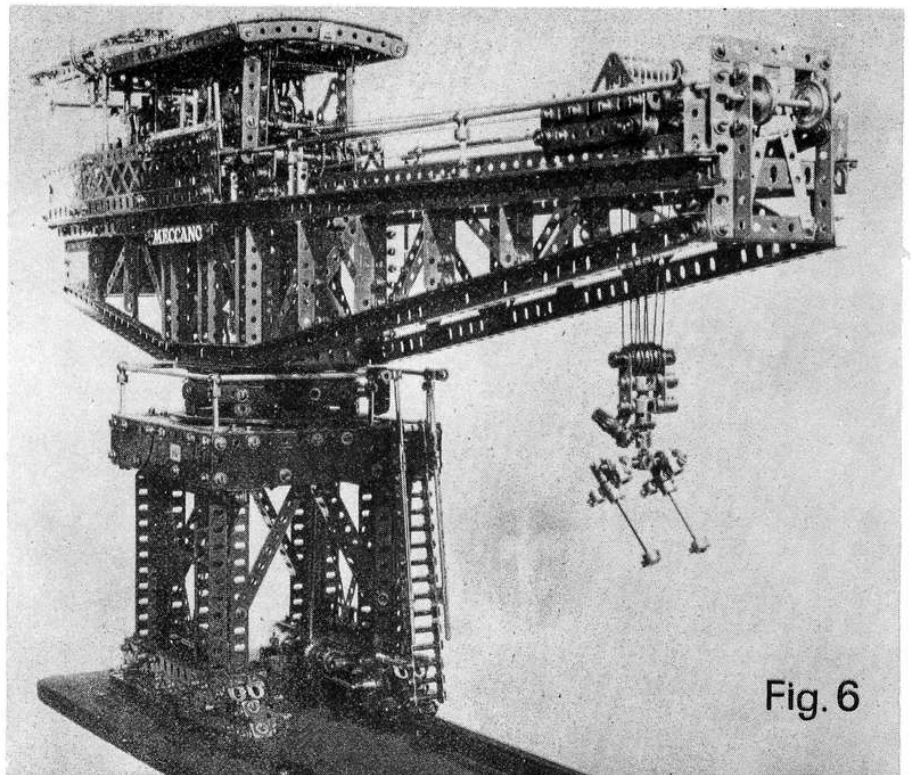

Fig. 6

TABLE-TOP BLOCK-SETTER

by MICHAEL MARTIN

*

**Assembly notes
for the cup winning
Crane featured in
the Jan.'75 MMQ**

*

These assembly notes are intended for use in conjunction with the photographs of the Blocksetting Crane appearing in the January 1975 issue of Meccano Magazine Quarterly.

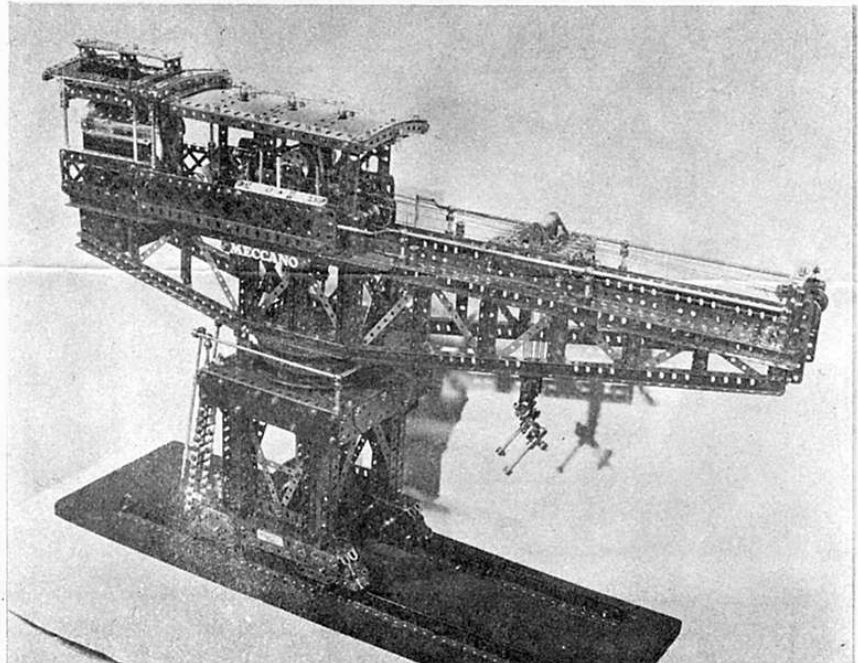

GIANT BLOCK-SETTING cranes have always been popular in Meccano, but advanced models have usually been powered by electric motors. It seemed a good idea therefore to try to drive such a crane entirely from a single Meccano Steam Engine.

It has been said times without number that, with complex models, it is essential that all moving parts run freely. This crane weighs 30 lbs and, unless every gear, pinion and axle runs freely when installed, there will not be sufficient power at the track for the crane to move. It is no good hoping that a binding gear will loosen up; it won't, and will be difficult to trace once it becomes just a part of the whole train. Incidentally, the Steam Engine used was modified to enable it to run repeatedly at exhibitions, without causing rusting to its supporting structures, and was placed in an aluminium tray to restrain condensed water, but this is not essential.

GANTRY BOOM

Each side of the boom consists at the top of 'U' girders formed from two 24½" Angle Girders bolted

together by the slotted holes and butt-jointed by Strips to two 9½" Angle Girders similarly joined at the rear (see Fig.1). The bottom 'U' girders are likewise constructed, the forward end from 18½" Angle Girders, the middle from 5½" and the rear from 9½" Angle Girders. Top and bottom of the boom are connected at the front by 1½" Angle Girders facing inwards; along the centre section by three equally-spaced pairs of 3½" Angle Girders, arranged to form three 'U' girders and secured by Flat Trunnions top and bottom and, at the rear, by the outer edge of a 2½" x 2½" Flexible Plate which forms the end plate of the ballast box. The top 'U' girder projects one hold beyond this Plate. The rest of the vertical bracing can now be put in, using single Angle Girders attached at the back by 2" Slotted Strips and 1" Triangular Plates. At the front end 1½" and 2" Strips are used with Angle Brackets bolted to them to simulate girders. Cross bracings are Narrow Strips, with Fishplates being used where necessary to adjust for length.

On completion, the side frames should be compared and matched. They are spaced apart by two 3½" Angle Girders top and bottom at the

front and by three 3½" x 2½" Flanged Plates at the rear, the latter bolted around the 2½" x 2½" Plates mentioned above to form an open-topped box for the counterweight. Each side frame has a 4½" Angle Girder bolted along the back of both the front and the rear vertical 'U' girders and the two side frames are joined top and bottom by four more 3½" Angle Girders. At both front and rear of the centre section, 5½" Strips are bolted diagonally from the top of each side across to the bottom of the other side, thus forming a rigid box above the turntable. Flat Girders, projecting inwards, are fixed, end to end, all along both sides of the top and, to these, are attached 18½" Angle Girders at the front to form the trolley rails (see Fig.2).

ENGINE MOUNTING

After putting sufficient ballast in the ballast box to counterbalance the front end of the boom, the Meccano Steam Engine is bolted to the rear end, with a 4½" x 2½" Flat Plate in front to form the bottom of the gearbox. The gearbox sides each consist of 3" x 1½" Flat Plates, fixed to the Steam Engine

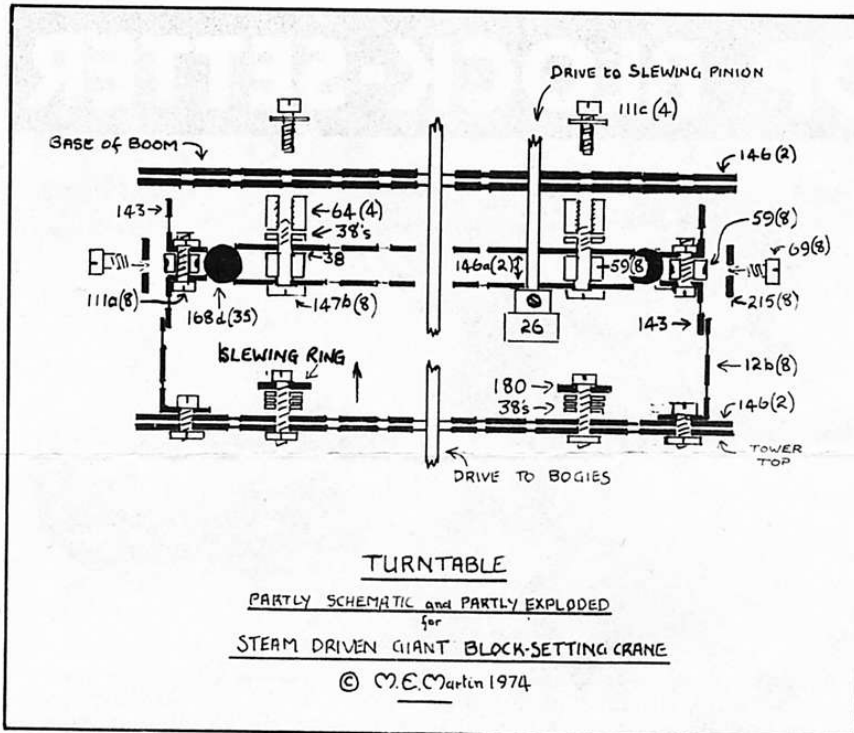

Diagram by the author showing the sturdy construction of the turntable.

side plates, and leading on to $4\frac{1}{2}$ " x $2\frac{1}{2}$ " Flat Plates and Flat Girders, all secured to the base plate by Angle Girders as shown in Fig. 3.

TURNTABLE

The turntable is a captive ball-race. The outer race, to be secured to the tower, is made from two $5\frac{1}{2}$ " diameter Circular Girders, back to back, but spaced apart by eight Collars held by $\frac{1}{2}$ " Bolts. The centre race is two 4" diameter Circular Plates held apart by eight Collars and additional Washers, each Collar being secured by Pivot Bolts. The distance apart of the two plates is critical and some experimenting will be needed before the ring of Ball Bearings, fed into the gap between the inner and outer races, will move freely without shake. The centre plate, minus the top plate and Pivot Bolt nuts, should be placed on a flat surface, the outer race placed around it, and Ball Bearings placed around leaving a small gap. The top plate is then dropped on and the nuts secured. Slackness will mean thinner washers are needed and Electrical Set Washers will prove useful. Make certain that everything is concentric and that the Collars used on the outer race are as far out as they will go. When satisfied, grease lightly and replace four alternate Pivot Bolt nuts with Threaded Bosses,

raised by Washers so that their tops just clear the raised flange of the Circular Girder.

The top of the gantry support tower is a $7\frac{1}{2}$ " square box built up from $7\frac{1}{2}$ " Angle Girders at top and bottom and spaced apart at the corners by $1\frac{1}{2}$ " Angle Girders. The sides are filled in by overlapping $5\frac{1}{2}$ " x $1\frac{1}{2}$ " Flexible Plates reinforced by $2\frac{1}{2}$ " Semi-circular Plates (see Fig. 1). Across the inside of this box top, two more $7\frac{1}{2}$ " x $1\frac{1}{2}$ " 'U' girders are fitted parallel to one another and $5\frac{1}{2}$ " apart, and yet another pair of $5\frac{1}{2}$ " x $1\frac{1}{2}$ " 'U' girders stretch between these two girders to make an internal box square $5\frac{1}{2}$ " x $5\frac{1}{2}$ ". The space between the inner and outer frames is filled in on top by $1\frac{1}{2}$ " wide Flexible Plates with $2\frac{1}{2}$ " x $2\frac{1}{2}$ " Triangular Flexible Plates filling in the internal corners. Two 6" diameter Circular Plates are bolted to the centre of the $5\frac{1}{2}$ " square and are raised slightly on Washers. A Gear Ring, raised by three Washers, is bolted to the Plates and carefully centred. Underneath the tower-top, along two opposite sides, pairs of $7\frac{1}{2}$ " Angle Girders are bolted, each pair back-to-back, their downward flanges to be used to attach the tower legs.

Each leg consist of four $5\frac{1}{2}$ " Angle Girders making an 'H' girder (with $4\frac{1}{2}$ " Flat Girders strengthening the web) bolted to the tower top and to another back-to-back pair of

$7\frac{1}{2}$ " Angle Girders on the base of the tower, these being strengthened by Flat Girders. Each base is an open-ended, three-sided box girder constructed from three $7\frac{1}{2}$ " Flat Girders joined by Angle Girders and Girder Brackets (see Fig. 4). The bogie sides are $2\frac{1}{2}$ " Flat Girders extended at the bottom, one hole each end, by $3\frac{1}{2}$ " Strips, the sides being spaced apart by $\frac{1}{2}$ " x $\frac{1}{2}$ " Double Brackets and Washers to allow the three $\frac{1}{2}$ " Pulleys with bosses to have some space to move. All fixed pulleys and gears need two Set or Grub Screws.

BOGIE DRIVE

The bogies float on Axle Rods secured in a Double Arm Crank bolted top centre in the bogie. These Rods pass through the sides of the base and extend inwards far enough to allow a 60-teeth Gear Wheel to be fitted on it, free to turn and held on by a Collar. On each bogie, the two end $\frac{1}{2}$ " Pulley axles also extend inwards and have $\frac{3}{4}$ " Pinions fitted which mesh with the 60-teeth Gear Wheel. The centre Pulleys are not driven.

The all-important drive to the track will pass down through the gearbox base and on down, via a Flexible Coupling Unit, to a gearbox in the bottom centre of the tower top. Here it splits sideways through a 2:1 reduction system to travel down the centre of each side by means of an Axle Rod, journalled at the bottom in a Threaded Coupling attached to the inside of the base. Here a $\frac{3}{4}$ " diam. Bevel Gear drives two more $\frac{3}{4}$ " Bevels on short horizontal Axle Rods also running through threaded Couplings and with $\frac{3}{4}$ " Contrates on the ends. These mesh with $\frac{3}{4}$ " Pinions, free to rotate on stub axles on the base side and meshing with the 60-teeth Gear Wheels mentioned above. It is worth spending time on these gears - which must be secure, but absolutely free-running.

ASSEMBLY

Assembly can now start to complete the crane. The turntable can be attached to the tower by Angle-Brackets, but a neater result is obtained by bolting a ring of eight 1" x $\frac{1}{2}$ " Angle Brackets to the outer holes of the tower's Circular Plate. The turntable will fit inside this ring. Formed slotted Strips are placed around the ring and the whole

lot secured by eight Set Screws screwed into the threaded holes of the spacing Collars on the Circular Girders. Before fitting the turntable, a 1/2" Pinion is fitted on a 2" Rod passing through the pair of holes in the centre race so that it will engage with the inside teeth of the Gear Ring which is attached to the tower top. A 6" Circular Plate is bolted to the base of the boom using 1 1/2" Flat and Angle Girders, and the boom with the Plate is placed on the turntable, so that the 2" Rod passes to the rear of the centre hole and a Collar is fitted. Four Bolts through the Circular Bosses hold the assembly firmly in place.

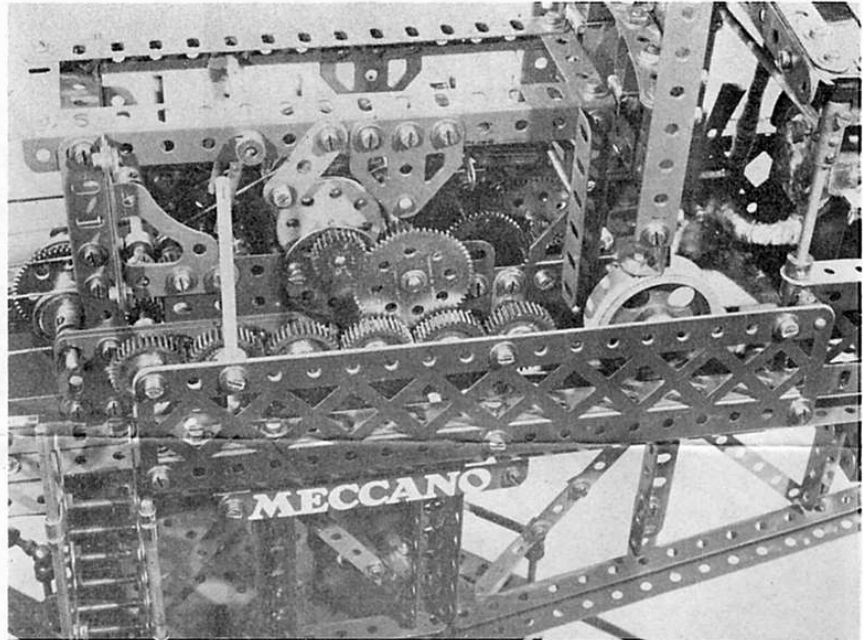

This photograph, reproduced from the January 1975 issue of the MMQ, shows the gearbox which is built into the Block-setting Crane. A diagrammatical view of the gearbox, drawn by the author, appears below. A complex unit, it allows all movements of the model to be powered by one Meccano Steam Engine.

GEARBOX

The diagram of the gearbox shows just one horizontal plane from the crankshaft to the trolley rope pulleys. A compact gear train drives a Rod with a 1" Gear which drives a further five 1" Gears. Staggered along the Rods and turned by these Gear Wheels are 1/2" Pinions. Between these Rods are further Rods which slide in and out under control of vertical handles fitted to Swivel Bearings at the end. The handles pass downwards into the ends of four Couplings which have a Rod passing through all four of them (with Washers filling in the

spaces). This Rod is held by a Double Angle Strip bolted to the deck of the crane. The sliding Rods have 1/2" Pinions held by Collars and free to rotate. In the neutral position no power is transmitted to these 'idler' Pinions, but, pushed in or out, they

engage the rotating Pinions and turn one way or the other.

Journalled in the gearbox sides beneath Rod 1 is another Rod (held by Collars) on which a 1/2" x 1/2" Pinion is secured, this Pinion meshing

continued →

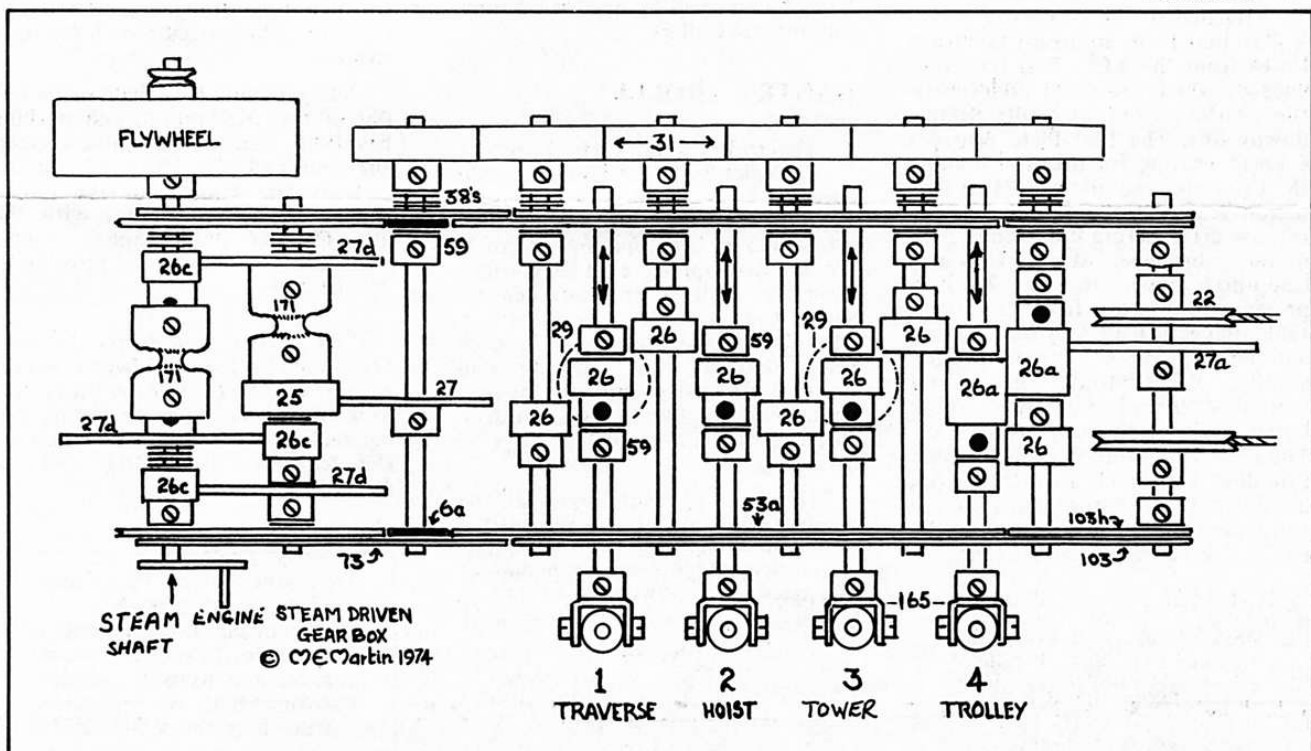

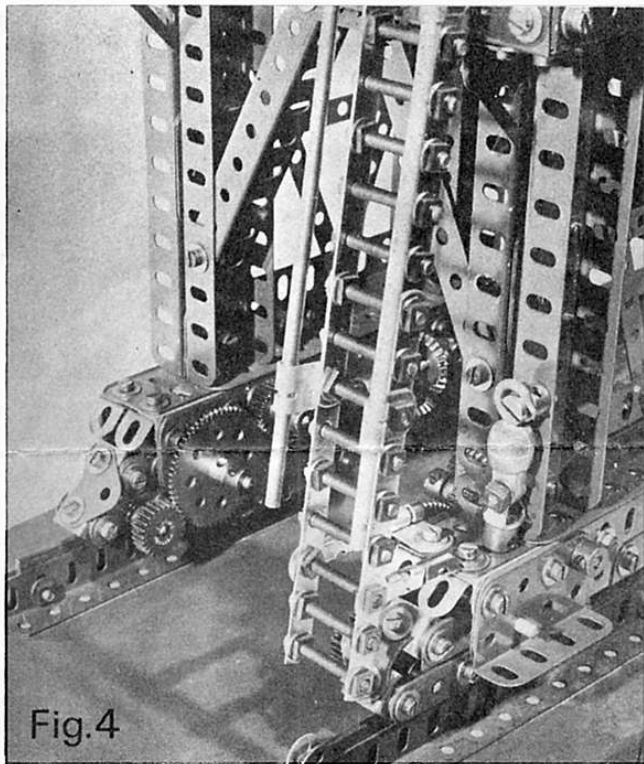

Fig. 4

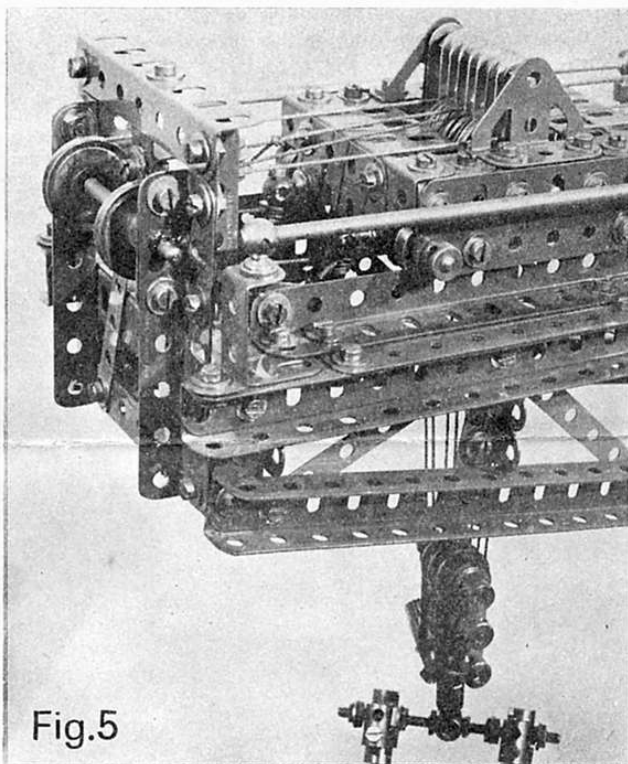

Fig. 5

Two more photographs reproduced from the January 1975 MMQ. Left, the tower base showing details of final spur drive, ladderwork and auxiliary hook stowage. Right, gantry head details and trolley construction.

with the idler Pinion above it. Passing up through the gearbox floor beneath it is a vertical Rod on which a $\frac{3}{4}$ " Contrate is fixed to engage with the $\frac{1}{2} \times \frac{1}{2}$ " Pinion.

Attached to the corners of a $2\frac{1}{2}$ " x $2\frac{1}{2}$ " Flat Plate are four Cylindrical Cores from the 4 EL. Set, the other ends of which are fixed underneath the gearbox floor by Bolts passing downwards. The Flat Plate provides a lower bearing for the Rod holding the Contrate, and allows further reduction gearing to be installed to the traverse drive, before it descends once more through two Universal Couplings down to the 2" Rod projecting upwards from the turntable. Beneath Rod 3 in the diagram another $\frac{1}{2}$ " x $\frac{1}{2}$ " Pinion driving another $\frac{3}{4}$ " Contrate on a Rod journaled in a Double Arm Crank bolted underneath the gearbox floor. The drive is continued via a Flexible Coupling Unit and a further Rod, on down through the centre of the turntable to join the gear train to the tower drive as mentioned earlier.

Rod 2 has a $\frac{1}{2} \times \frac{1}{2}$ " Pinion above it, its Rod projecting into the space between the gearbox side and the row of 1" Gear Wheels. There, a $\frac{3}{4}$ " Pinion takes the drive up and forward to a 60-teeth Gear Wheel on whose axle the winding drum is

mounted. A brake will be needed on this drum, but the modeller's own type can be used. Both ends of the cord are wound on this and it should have a central divider. Small $7/64$ " Grub Screws will be needed on some Pinions and Collars.

GANTRY TROLLEY

The trolley sides each consist of two parallel $3\frac{1}{2}$ " Flat Girders joined together at each end by Channel Bearings. The two sides thus formed are joined at each end by 3" Angle Girders overlapping 3" Flat Girders. Four $\frac{1}{2}$ " Pulleys are mounted on short Rods, one at each corner. A Trunnion is fixed centrally to each side and six 1" Pulleys are mounted on a Rod passing through the top centre holes of the $3\frac{1}{2}$ " Flat Girders. Rope guides are supplied by $1\frac{1}{2}$ " Strips.

The hoisting cable starts at the winding drum, passes over the outside Pulley then is taken down to the hook sheave which has four $\frac{1}{2}$ " Pulleys – and passed under the outer $\frac{1}{2}$ " Pulley. It is then taken back over the next 1" Pulley, down and up again and then on to the end of the boom where it passes round a strategically-placed Pulley on a vertical Rod before being taken back to the trolley

over pulleys four, five and six and then further back to be tied to the other side of the winding drum. Thus the winding drum winds in both ends of the cord, preventing the irritating tilting and twisting of the hoist which occurs with multiple sheaves.

Many details have had to be left out of this description, and nothing has been said of the Filders Gear, the roof and side structures on the rear of the crane, nor the pulley frame at the front, but with the aid of the photographs – and patience! – it should be possible to construct it.

The author would like to acknowledge the helpful advice supplied to him by Mr. B. N. Love (who also took the photographs reproduced in connection with this description in the January 1975 MMQ) and by Mr. H. J. Halliday.

We regret that no Parts List is available for this model. Quite understandably, the author dismantled the model, without preparing a parts list, before knowing that we wished to feature it in the MMQ. Sorry!