

## COLIN HAMILTON looks at DYNAMOS FOR SHOWMAN'S ENGINES

Steam Fairs are a popular hit with the public at large and Meccano enthusiasts in general, and the rides in such a fair should all be driven by individual steam engines built into the gallopers, cakewalks, steam yachts etc if the fair is to live up to its title. However, steam has a number of disadvantages, not least of which are the humping of coal and the time-lag in getting up steam.

As fairground rides became more complicated, the advantages of electrical power were utilized both for movement and illumination. By generating such electricity at a central point and feeding it across the fairground by cable, economy and convenience were achieved.

Normally a Direct Current is required for fairground machinery so that DC motors can be used with speed control circuits. In addition to this, the voltage is commonly about 120 volts (instead of the UK mains standard of 240 volts) as the lower voltage is considered to be below the lethal level in the case of electric shock.

As the steam traction engine evolved into the Showman's Road Locomotive, the role of the flywheel driving

agricultural machinery was changed to that of driving a dynamo mounted on a special cantilever bracket extending forward over the smoke box. Hundreds of examples are still seen today thanks to the enthusiasm which has preserved these juggernauts of the steam age, and the most common type is that of a single-unit dynamo often designed to supply the fixed set of 'rides' which that showman's engine towed from fair to fair.

When the heavy-duty compound Burrells came on the scene, their additional horse-power enabled them to drive more powerful generators, but there is a limit to the size and weight of a dynamo which can be carried on a cantilever boiler bracket. In addition to this, the electrical 'load' carried by the dynamo could vary considerably according to the number of fairground rides in operation, their frequency of operation, and the standing load of illumination around the fairground.

Fig 1 shows a method by which this problem was overcome: the famous Burrell showman's engine *Winston Churchill* is shown with two machines on different boiler mountings. The one in

the normal place on the cantilever bracket is the main dynamo, and the smaller machine on the saddle bracket is known as a 'field exciter'. Both machines generate electricity, but that coming from the smaller machine is fed to the field coils of the forward dynamo to control the power output against the demand or 'load' of the fairground rides being energized by the showman's engine's dynamo. The smaller 'field exciter' and the main dynamo both have cover plates with instructions showing how machines can be converted from dynamo to motor operation.

The general shots of Figs 1 to 4 show the two dynamos and the arrangements of brackets and belt drives from the main engine flywheel and from the offside pulley of the main dynamo to that of the field exciter. A number of modellers have reproduced this system, and a compact design is shown in the two well-known Meccano Books by Bert Love; on pages 81 and 83 of *Meccano Constructors' Guide* and pages 81 and 82 of *Model Building in Meccano and Allied Constructional Sets*.

Given a little thought and the unorthodox application of standard Meccano parts, it is possible to make dynamos of pleasing and realistic appearance. Taking the simplest form as conceived by the Model Room at Liverpool, Fig 5 shows a rather stark representation which has been used on the large-scale dealer's model of the Meccano Showman's Engine and has very little to commend it as a dynamo. However, as a large number of these had to be produced and assembled with an economy of parts and time, the bare outline served its purpose.

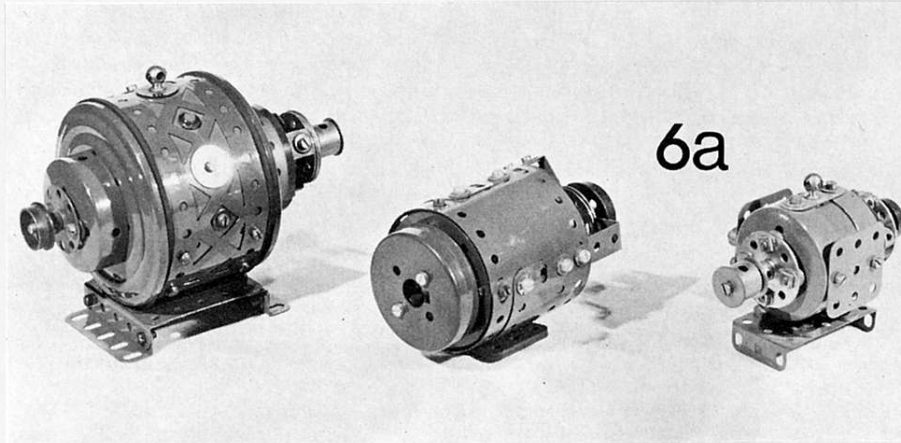
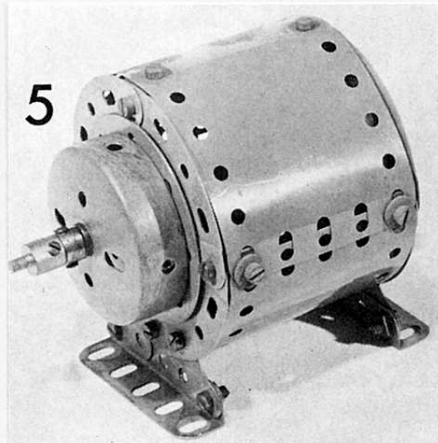

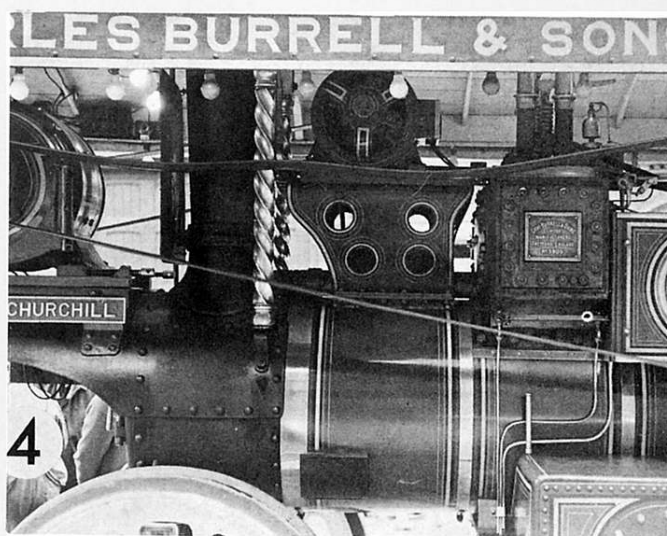
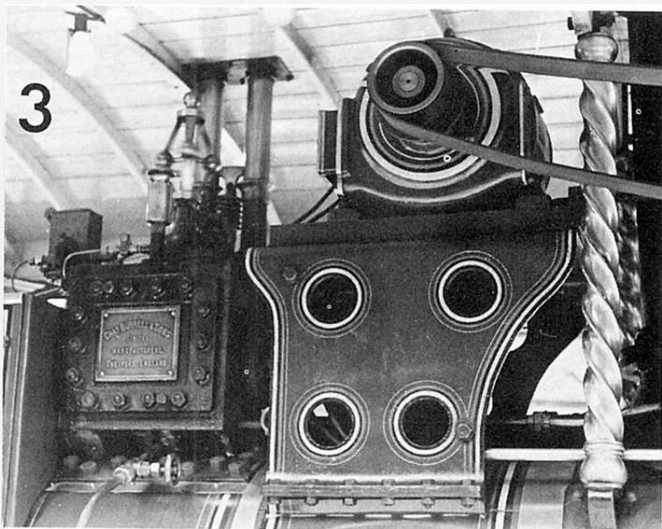

However, as the illustrations in Figs 6a and 6b show, it is not very difficult to make rather more interesting and realistic dynamos from standard parts. The smallest dynamo shown on the right of the photographs is still simple in construction, being two Boiler ends joined by an internal 2½" x 1½" Flexible Plate, and the two 1½" Flexible Plates make a firm reinforcing, at the same time providing a heat shield for proximity mounting by the boiler chimney and, on the front side, a large terminal/dial board simulated by Collars on the middle row and Washers on the lower one.

Some years ago, Meccano Ltd, produced an all-black small Flanged Wheel, and these are worth preserving for use in mechanisms where the 'brassy' look is out of place. One of these is used as the offside back drive on the small dynamo while the main drive pulley is a double-flange type made up as follows. A Rod Socket is fitted with a ¼" Washer and a Chimney Adaptor which is locked in place on the threaded portion of the Rod Socket by a Threaded Boss. This, in turn, allows the outer ¾" Washers to be secured by a standard Bolt. If an antivibration fixing is required here, the outer ¾" Washer should be packed internally with standard or brass shim washers [Meccano Electrical part 561].

It is normally possible to see the bush gear and commutator on a fairground dynamo as one side is of open construction, and this has been achieved in each of the dynamos illustrated here. The medium-size machine on the left in Figs 6a & 6b has its diameter set by one external and one internal Face Plate

attached to the external series of four 2½" Flexible Plates by Threaded Bosses, and this time the drive pulley is a large Flanged Wheel, also black, having been retained from the days of the 'black' parts.

The largest of the three Meccano designs is shown in Figs 7a & 7b, and its 'brush' gear is almost identical to that of the middle-sized dynamo.

A pair of 6-hole Wheel Discs form the outer bearing plate, and these are stood off from the Boiler End by a combination of 1" x ½" and ½" x ½" Angle Brackets overlaid by electrical Insulating Fishplates [Part 513]. A Socket Coupling forms the 'commutator' in this dynamo, and one end holds a Collar into which a Threaded Pin is inserted through the Wheel Discs so that a drive pulley — built as previously described — can be close coupled to the end bearings.

If Meccano bossed wheels are used, they often add that little extra width to the dynamo which makes it unwieldy when mounted on the engine bracket and this can put the dynamo drive right out of line with the flywheel belt. Some ½" Bolts, fitted with brass shim washers are passed through the fibre Fishplates to act as 'brushes' for the commutator.

It so happens that a Boiler End will fit inside a Wheel Flange and still leave room for a ring of 2" Brass Flexible Strips [Part 530] to add 'gold line' decoration to the dynamo, and this can be seen in Fig 7a.

Ball Race Flanges form the outer ends of the dynamo casing, and a combination of internal Threaded Bosses and Threaded Rods hold these end plates together, at the same time trapping a 7½" Strip Plate curved between the Flanged Rings.

A 1½" Braced Girder (obsolete pattern) adds decoration and coverage to the dynamo case with holes filled in with Washers, and a neat capping is provided by a Handrail Support.

The object of this article is to get Meccano modellers thinking about the application of standard parts in unorthodox places to exploit the system to a wider degree. The human eye resolves detail better than the finest camera, and the observant modeller can re-create prototypes to a surprising degree of realism, as is shown by the superb Meccano models which grace the various club displays and exhibitions to which we are accustomed today.

Even the humble rubber band has a place; note that an otherwise ugly row of holes would show on the inner Strip Plate used for the large Meccano dynamo, but a pair of 10" Heavy Driving Bands are placed round the frame — just touching the rim of the Ball Race Flanges — and this adds the finishing touch!

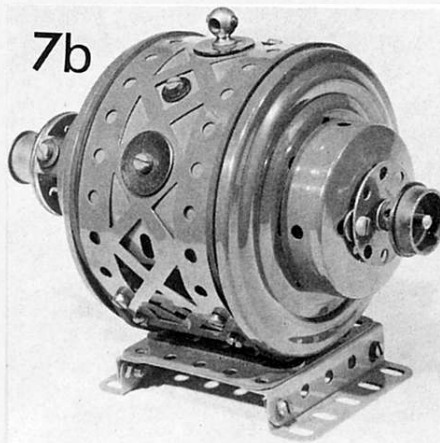
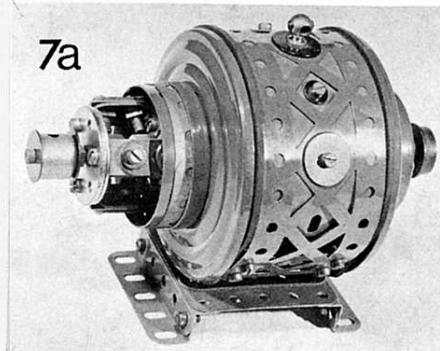
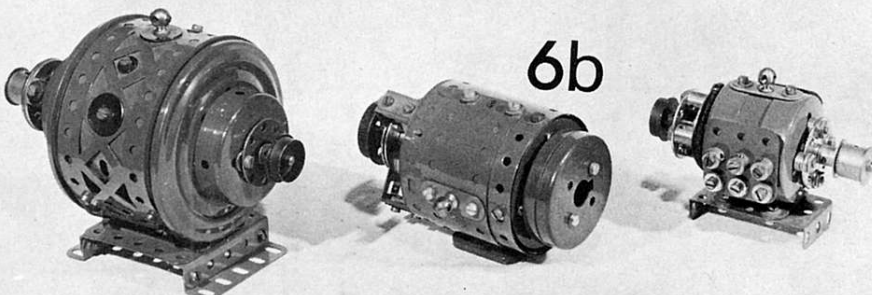

Modelling Showmen's Engines and Traction Engines in Meccano has now reached a very advanced form as the various Meccano Shows up and down the U.K. have proved in recent years, and the high standards achieved have been obtained by painstaking detail reproduced in standard Meccano parts and by close study of the correct proportions of the prototype on which the particular model is based. When a "glamour" shot of a real life showman's engine is taken, it is often done so from the view which clearly shows its front end, often because this is where detail and ornamentation proliferate as Fig. 1 illustrates. Winston Churchill is a Burrell compound Showman's Engine still taking pride of place at many a Steam Rally and such engines are favourites for Meccano modelling. However, choice of parts is very important and the selection of the Circular Girder or Hub Disc both for front wheels and for boiler dimensions is bound to get the proportions wrong immediately. It is quite

obvious in the case of the Burrell, looking at Figs. 1 and 2, that wheel diameter and boiler diameter are quite different.

If the smaller scale of modelling is adopted as in Figs. 5 and 6, then the 3" Spoked Wheel and the Meccano Boiler do give a reasonable proportion, but if the front wheels are based on a 5½" diameter, then the boiler must be reduced in diameter to compensate and the illustrations in Figs. 7 and 8 show excellent results by advanced model-builders in getting the proportions right. We must be careful not to be too pedantic about proportions because they vary according to maker and as to whether an agricultural machine or a road locomotive is being modelled.

Constructors who want the best take the trouble to write to the makers, or to study published works giving full dimensions (and often detailed drawings) of the prototype they wish to model. They then do some careful paperwork to scale down the original.

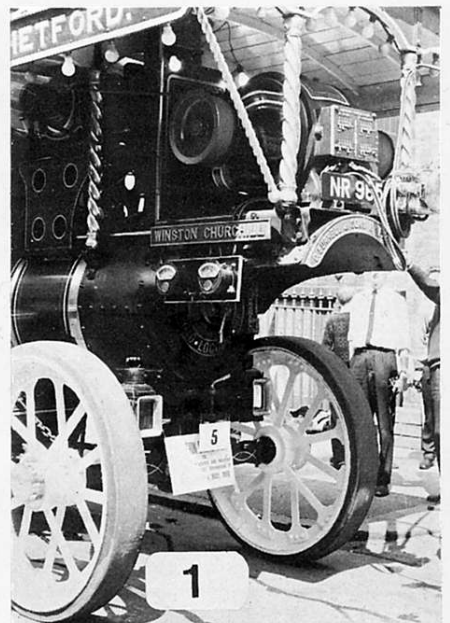

**In this second article on traction engine modelling COLIN HAMILTON looks at ...**

## **FRONT ENDS ON SHOWMAN'S ENGINES**

If a standard Meccano part does happen to scale in correctly and has acceptable internal proportions of its own, i.e. flange depths, etc., then all well and good, but where this does not apply, the patient enthusiast simply builds up the required part to correct scale. This often involves a high degree of skill, imagination and patience on the part of the model builder if he is to achieve the results shown by the standards of Figs. 7 and 8. Indeed, Fig. 8 shows a front wheel construction for a Burrell compound Road Locomotive in which everything is built up from Narrow Strips, Curved Strips, Wheel Discs and gently curved Flat Girders.

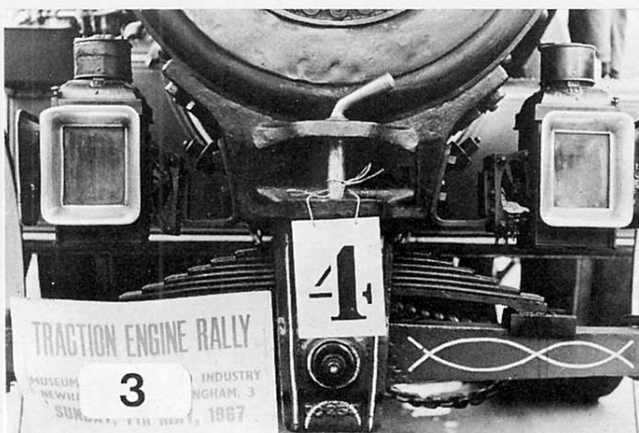

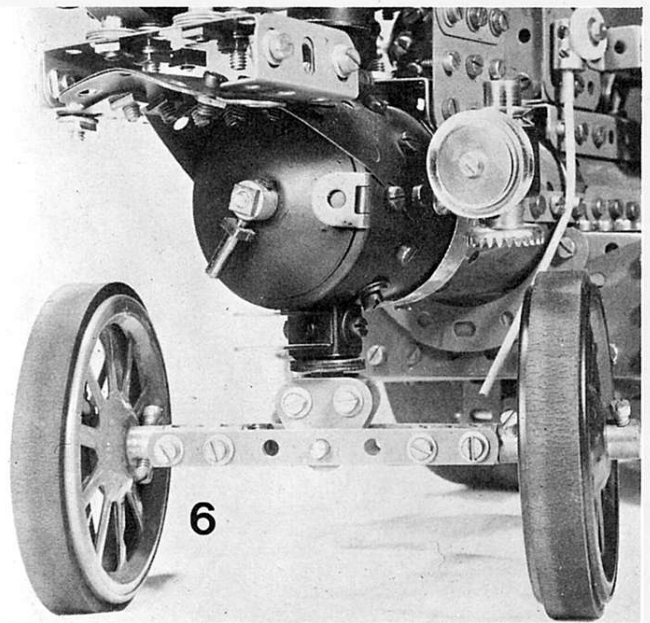
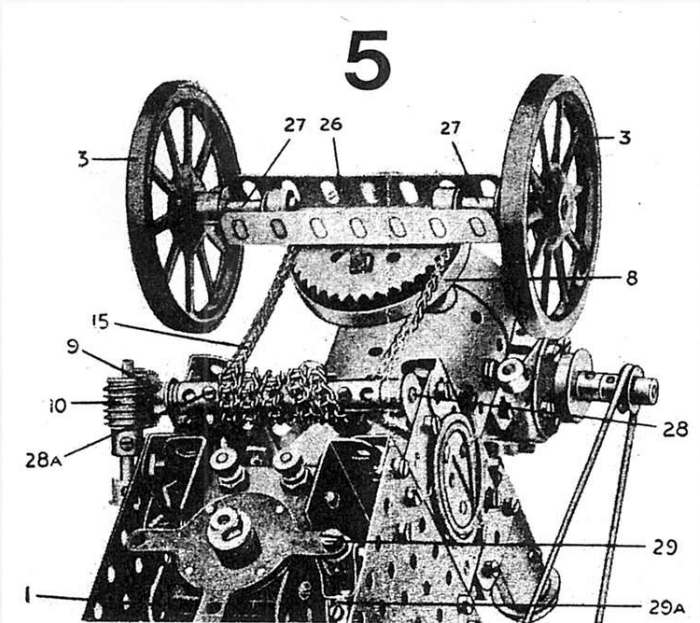

A well-loved, but badly proportioned pre-War design of Meccano Traction Engine has its steering gear shown from below in Fig. 5. The 2" Sprocket Wheel bolted solidly to a Wheel Flange give a rigid vertical steering pivot allowing no 'float' for the front axle when negotiating uneven ground. Some constructors have emulated this design and even incorporated Meccano Ball Bearings in a complicated steering swivel. Scaled up, such ball bearings would be as big as tennis balls! Essentially, traction engines or road locomotives have a simple front beam axle on a simple, but universal, central pivot. This is clearly shown in Figs. 6, 7 and 8. These last two illustrations

show how the job can be tackled in Meccano parts. In the case of Fig. 7, the model of an agricultural traction engine, the axle beam is braced from below by a strut running back to the steering base and the necessary sideways deflection of the axle is catered for in the swivel design shown. Fig. 3 makes it clear that the Burrell Showman's Engine is provided with a sprung front axle and this is reproduced by the modeller in Fig. 8 from standard parts. In this case provision is made for a vertical rise and fall of the axle as the spring flexes. As in railway steam locomotives, the smoke box needs cleaning and an access door is required, as the close-up of the Burrell's front

shows in Fig. 4. It is interesting to compare how two different advanced model-builders have tackled the reproduction in Figs. 7 and 8. Again, prototype makers are different for the two models and so is their work purpose and the boiler/wheel diameter ratio is not the same. These differences have been catered for in both models. A careful study of the illustrations in this article should help the enthusiast to discover the forms and details of the prototypes and some of the building techniques required to obtain realism in a Meccano model. A wealth of details abound on models and prototypes alike, but these will be dealt with separately in a later article.

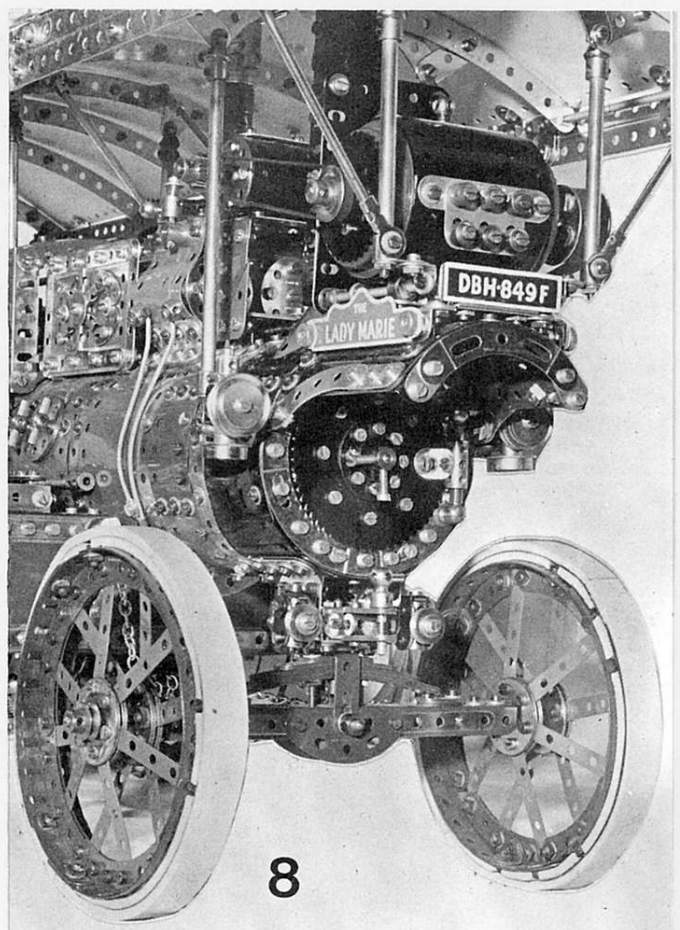
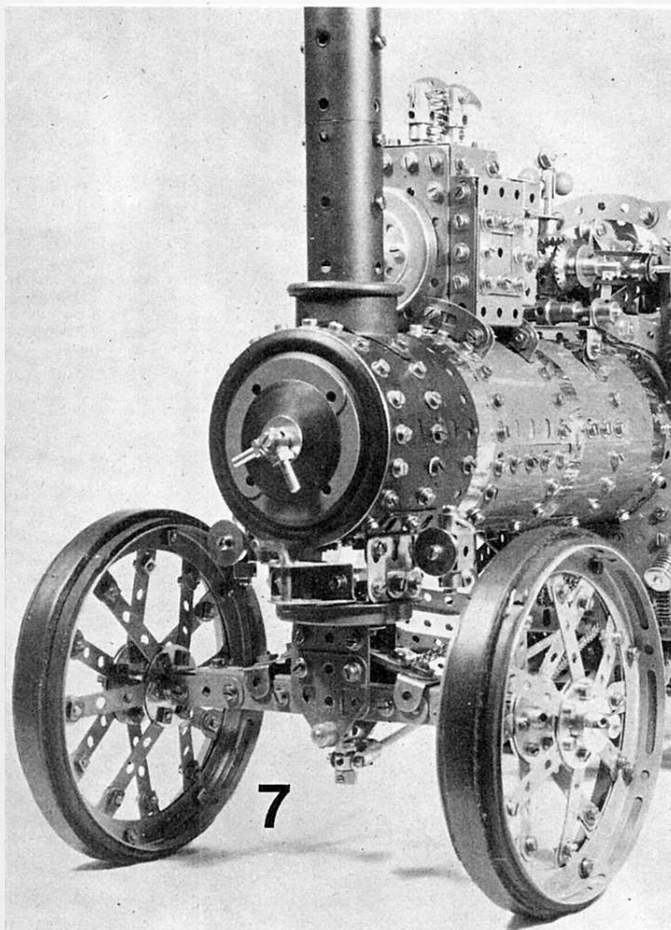

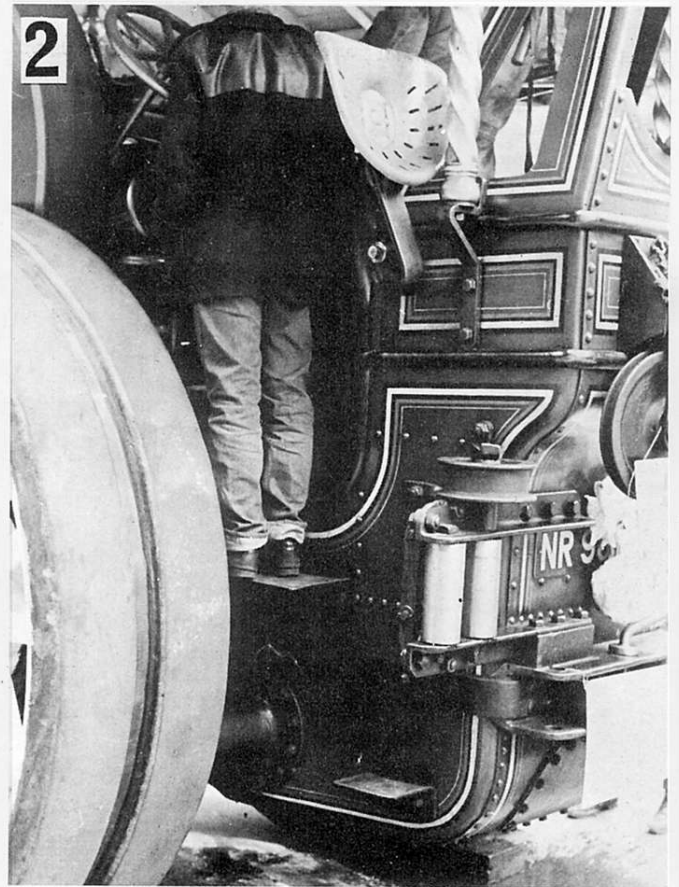
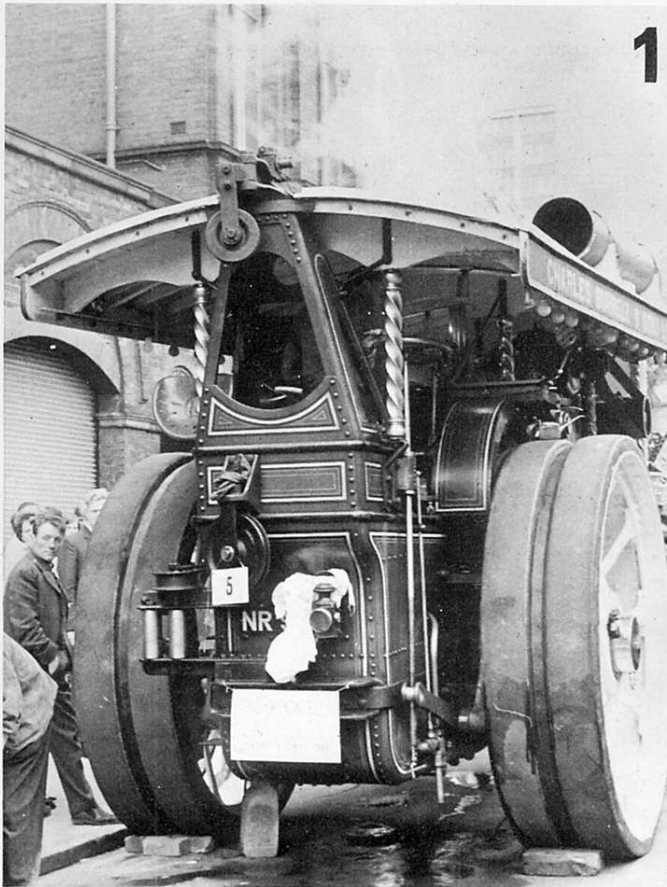

**Continuing his series on traction engine  
modelling, COLIN HAMILTON deals with**

**REAR ENDS OF  
SHOWMAN'S ENGINES**

To the enthusiast's eye, the tail end of a good showman's engine is as interesting in detail as the front, and once again the famous Burrell outlines are illustrated here in Figs. 1 and 2 to typify the design. Not only were these massive engines the hauling and generating work horse of the showground, but they were also the mobile cranes of their day. Study of Fig. 1 showing the rear of "Winston Churchill" reveals various pulleys and guides which were fitted to these road locomotives to enable them to carry out winching or hoisting duties. If, for example, a roller coaster was being erected on site, certain sections required hoisting well above ground level, so the auxiliary equipment for the Burrell included a strong derrick post with a heel pivot-pin and this was inserted in the draw-bar of the engine in place of the towing-pin shown in Fig. 2. A fixed "topping Lift" (wire stay) kept the derrick post at a set angle while the cable on the engine's winching drum was paid out round the roller and two guide pulleys which can be clearly seen in Fig. 1. Note that the lower guide pulley is off-set to one side on the rear bunker

plate to give a clear vertical lead to the hoisting wire. A pair of vertical rollers was also fitted at winch level to the rear of these engines so that straightforward horizontal winching for recovery or a remote derrick operation could be carried out.

A fine example of modelling the rear end of a Burrell compound is shown in Fig. 3 where the essential contours of the prototype are shaped in Flat and Flexible Plates. Strength and elegance are combined in the upper struts for supporting the derrick by use of standard Meccano Girders overlaid with Narrow Strips, a contrasting silver on green producing a very pleasing 'slimline' effect.

Most important is the scale of the bunker width which virtually matches that of the boiler diameter. A common fault, even today, in modelling traction engines in Meccano is to use a bunker width which is quite out of scale and which gives a very ugly squat appearance to the model. This trend was set some fifty years ago by the original Meccano Supermodel Leaflet for a Traction Engine and it is the

well-known pioneering Meccano specialists of the last decade who have put the matter right. Fig. 5 shows a rebuild of the offending pre-war model where the bad scale of bunker width to boiler diameter is clearly seen, apart from complete absence of driver access! However, even with the general overall size of the early Meccano model, much can be done to improve matters as shown in Fig. 4. This time, a bunker width of four-holed Strips gives the correct proportions when combined with the Meccano Boiler up front. Even at this smaller scale, additional details are easily modelled as the towing winch, rollers and neat draw-bar tow-pin bracket shows in Fig. 4.

Agricultural engines also need careful attention to their rear end proportions when modelled in Meccano and an excellent rugged example of this is shown in Fig. 6. Careful attention to outline modelling is the first priority, i.e. getting the general scale and shape right. All additional details such as lamps, handrails, driver's steps levers and steering wheels then compliment what is already a soundly designed and soundly built model.

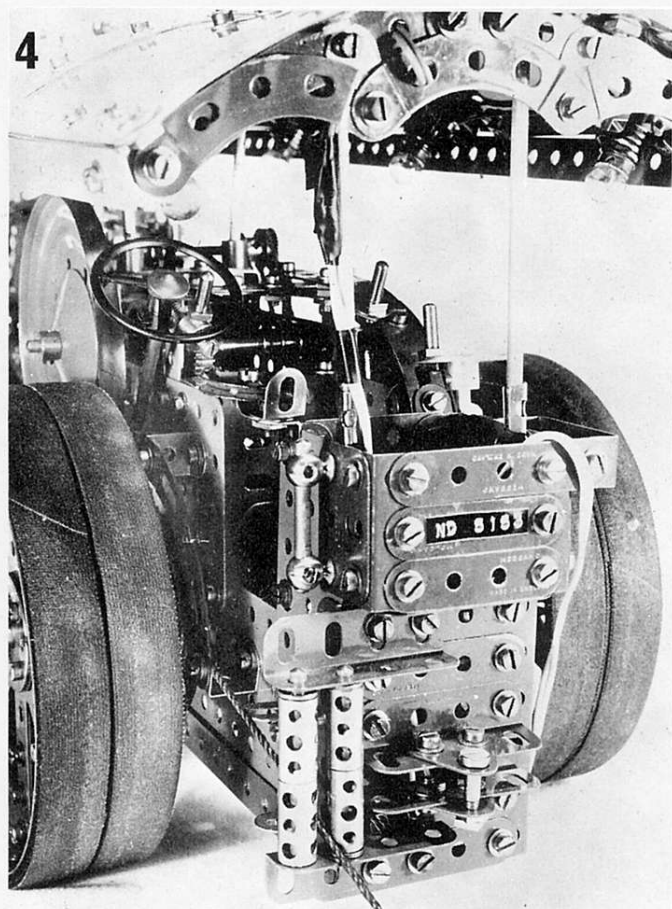
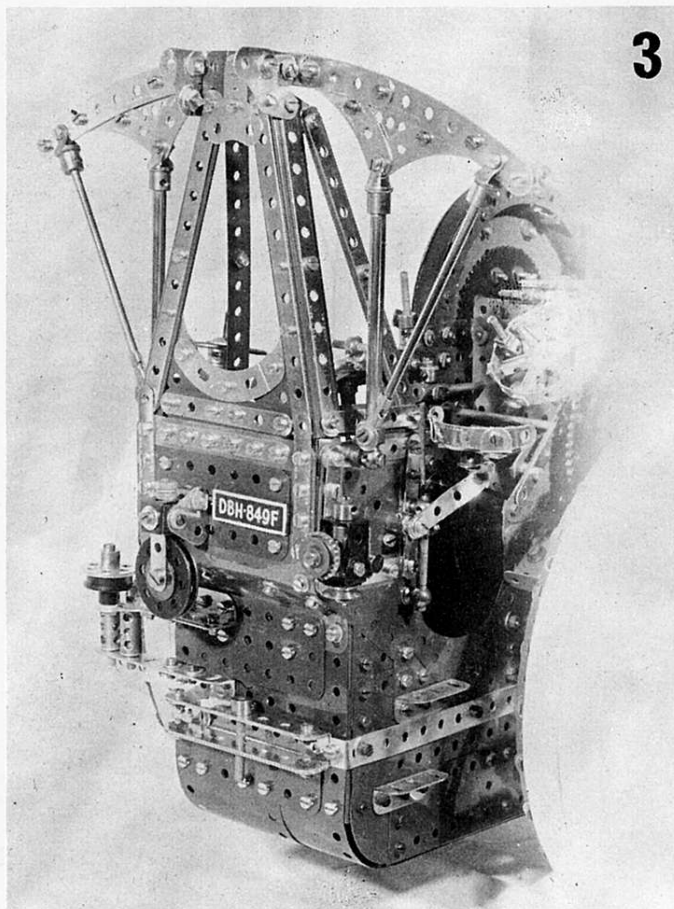

Fig. 1, a rear view of the well-known Burrell Compound Showman's Engine, "Winston Churchill"

Fig. 2, close-up of details on rear end of the Burrell. Note location height of vertical rollers and horizontal guide drum, and the off-set of the first derrick pulley

Fig. 3, a fine example of modelling on the rear end of a Meccano model of a famous Burrell Compound. Note excellent basic contours, scale and wealth of detail

Fig. 4, getting the scale right. Neat proportions of a well-designed model of the same basic size as that shown in Fig. 5

Fig. 5, how not to do it! Example of bad proportions on a pre-war Meccano Supermodel Leaflet design for a Traction Engine. Note "squat" and ugly shape of the rear end, with oversize width

Fig. 6, another example of excellent Meccano modelling on the rear end of an Agricultural Engine. Note the rugged wheel treads and clean access to the driver's compartment

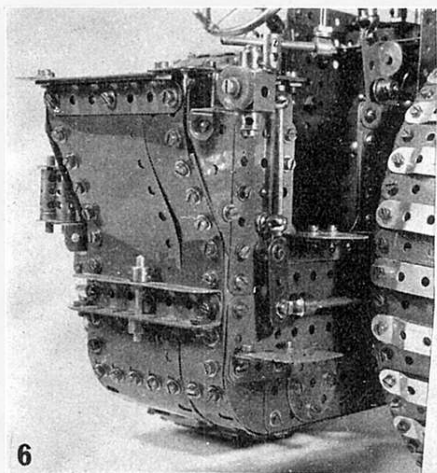
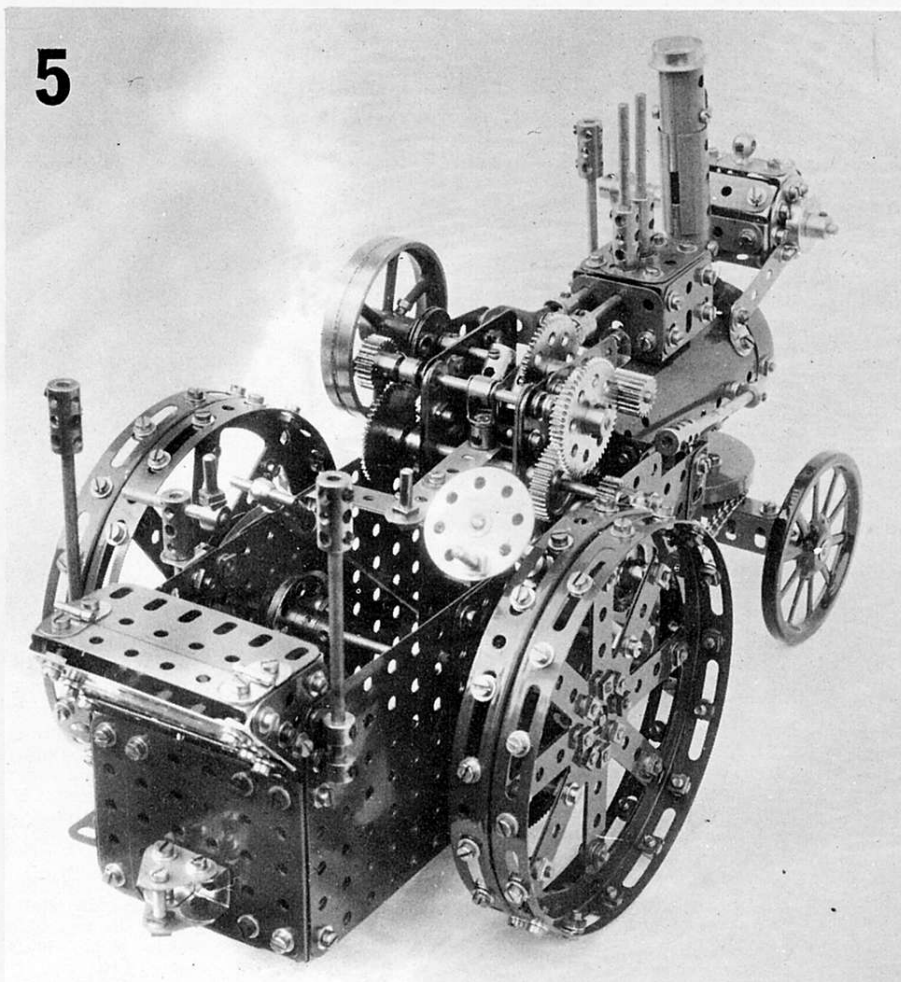

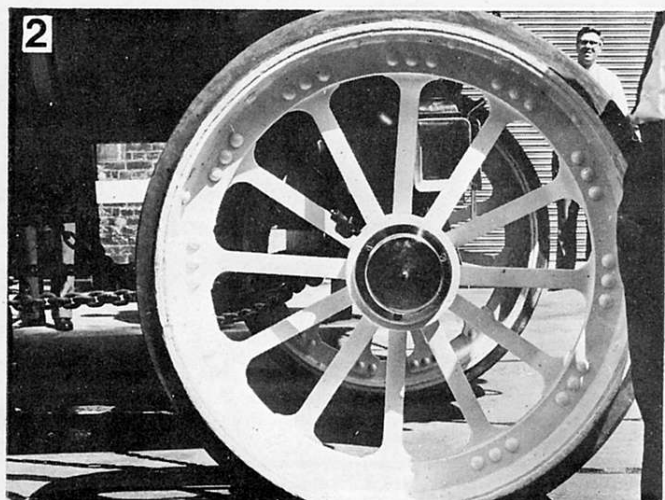
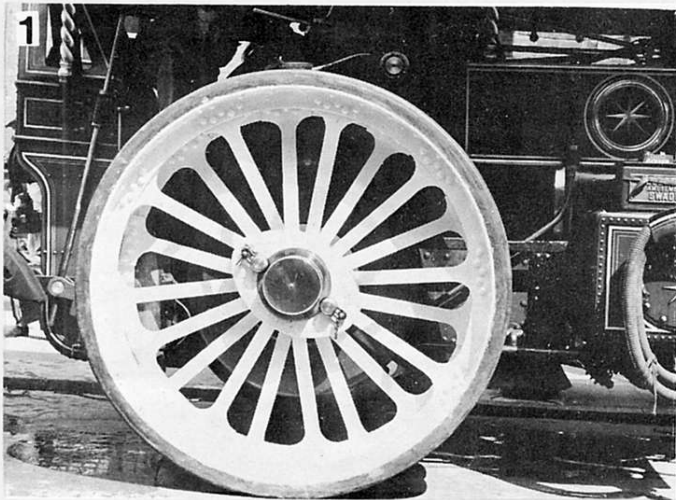

In Part 4 of his continuing series on traction engine modelling, COLIN HAMILTON turns his attention to ...

## ROAD WHEELS FOR SHOWMAN'S ENGINES

Given the tremendous appeal of the Showman's Road Locomotive to Meccanomen and general show-visiting public alike, it is surely incumbent on the modeller to achieve the maximum possible realism within the scope of his collection. Yet there is one area of the traction engine which, despite its high importance in overall visual effect, is often neglected. I speak of the road wheel which, front or back, is often a minor work of art in itself!

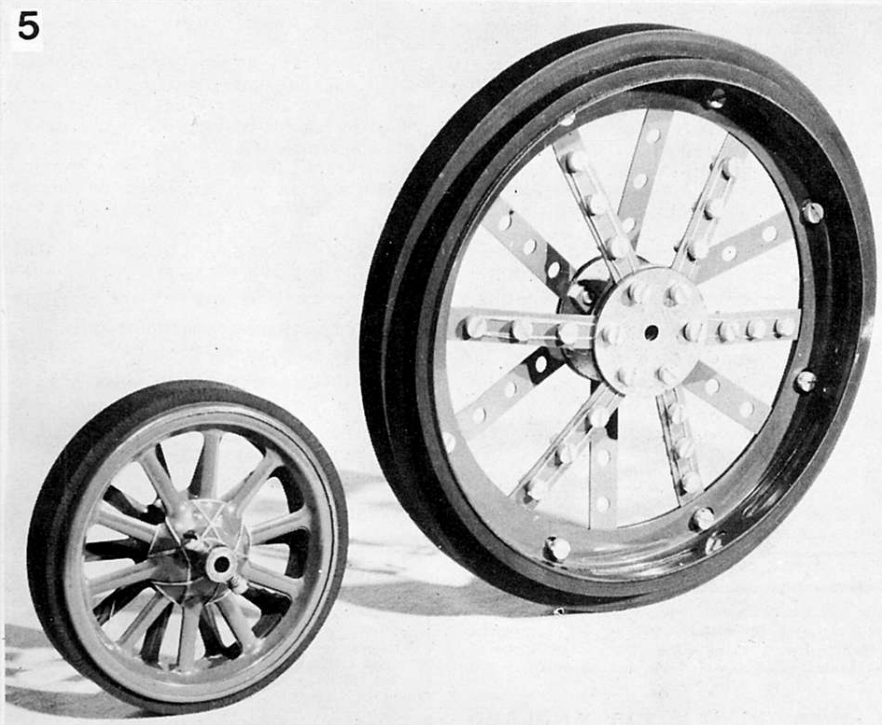

Designs of wheels for steam-driven road vehicles are many and various, but once again, a typical Burrell pattern is used as the basis for this article. Fig. 1 captures the elements of the rear wheel of a Burrell Showman's Engine in the stark silhouette which immediately shows a work of art as well as an engineer's sound design. Although the axle of the full-sized road locomotive is as thick as a man's arm, and a quite massive hub is forged to cope with the working and weight loads, the individual spokes of the wheel are slim and elegant by comparison. Nevertheless, the diagonal arrangement of the twenty radial spokes which gives an interleaved construction provides all the strength required and a stable wheel with high resistance to sideways buckling. Given a standard Meccano Boiler and a pair of 3" Spoked Wheels, the chances are that a Hub Disc will be pressed into service as the rear wheels of an elementary Traction Engine, or Showman's Locomotive, but the serious constructor would never be satisfied with this.

Fig. 4 shows just what can be done to break away from the Hub Disc. By using Circular Girders combined with Narrow Strips and by using a Socket Coupling holding a pair of 8-hole Bush Wheels in each socket, quite an elegant wheel can be built up giving the separated flanges required for the rear wheel of an engine. In the particular construction shown every spoke is secured at hub and rim, advantage being taken of Threaded Bosses which not only guarantee parallel spacing of the rims all the way round, but also provide captive points

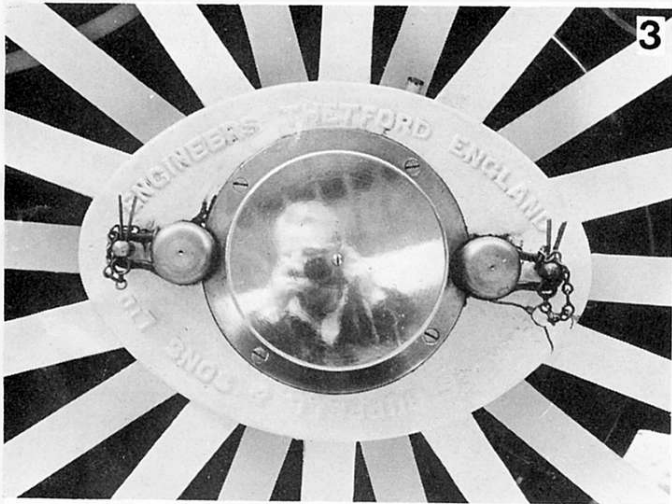

for the securing Bolts and leave no Nuts showing at the rims. It will be noted that substantial 'tyre' tread is supplied on the sample shown and these are actually used to trap double layers of Plastic Plates, 5½" x 1½" and 2½" x 1½", which form the outer faces of the wheels. Enterprising modellers keep a wary eye open for rubber belts on display in vacuum cleaner repair shops, lawn mower agents and washing machine stockists to make sure that they have a selection suitable for giving that professional rubber-tyred finish to their Showmen's Engines otherwise modelled in standard Meccano parts.

Looking at Fig. 2, which shows the front wheel of a Burrell engine, it will be noted that the wheel flanges are not separated. Since the greatest proportion of the engine's weight is located over the rear wheels, much lighter wheels of narrower 'tread' are required at the front end to facilitate steering. An acceptable simulation for the front wheels on the smaller scale is provided by Meccano 3" Spoked Wheels in pairs as shown in Fig. 5 and alongside this is a front wheel in Meccano parts when moving up to the larger scale road locomotives. Although Circular Girders and Narrow Strips are again the main components, only four of the twelve spokes are secured at the rim by bolting, the remaining eight simply being trapped between the Girder flanges as shown. Unless badly

distorted bends are set into the Narrow Strips (a common fault in much Meccano model-building of traction engines, etc.) the Bush Wheels or Wheel Discs chosen for the hub must not be widely separated, or the 2½" Narrow Strips employed will simply not reach to the rim. Since modern Meccano Nuts are hexagon and accept 4BA size spanners, constructors will find that the use of 4BA Nuts & Bolts (cry heresy!) will just give that little bit of allowance with their slightly narrower shanks to let the Narrow Strips 'stretch' to the four points of the rim where spokes are actually bolted to the Girders. Where spokes are simply trapped by pinching, standard Bolts may be used at the hub.

In the same way that Hub Discs are often the popular choice for one size of rear wheel on a Meccano Traction Engine, so the Large Flanged Ring is often (and wrongly) 'favourite' for the larger rear wheel. Study of Fig. 6 will show that exactly the same diameter of wheel can be achieved by the use of a set of eight 4½" Curved Strips giving the correct depth of flange inside the rims. The flange of part No. 167b is far too deep for realism. In the construction illustrated, pairs of Flat Girders, edge to edge or side by side, are curved in a Meccano jig or bending roller to fit the curvature of the 4½" Curved Strips and secured by Angle Brackets at strategic points as shown. Long Meccano Bolts

keep the wheel flanges parallel and overlaid 2½" Strips are set diagonally in every second slotted hole of the Flat Girders to join them round the face of the wheel. Something of a 'trick' is very successfully used in the construction of Fig. 6 to give the optical illusion of narrow spokes. This is achieved by overlaying the standard width Strips (in green) forming the spokes by 2½" Narrow Strips in silver. The illusion of narrow spokes thus created is quite striking.

Generally speaking, wheels on road locomotives are never fixed to their axles, but are free to revolve unless locked to the driving plate by pins. These can be seen in Fig. 3 on either side of the highly polished brass cap (reflecting the photographer at work!) Each locking pin has its own safety cotter pin preventing withdrawal of the locking pins by vibration. Both Figs. 6 and 7 show how this may be simulated in Meccano parts and in each case it will be seen that the model conforms to locking pin practice.

Finally, that extra touch of 'showground' decoration may be added to the wheels as shown in Fig. 5. Gold sewing thread is simply woven in and out of the spokes on the 3" Spoked Wheels and locked under boltheads on the Narrow Strips used in the larger wheel of Fig. 5. Rubber belts complete the realism.

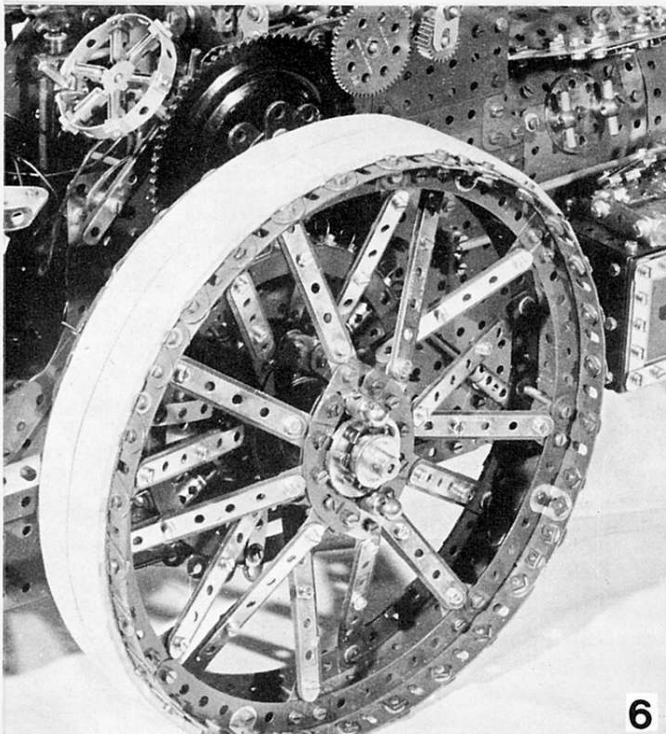



1

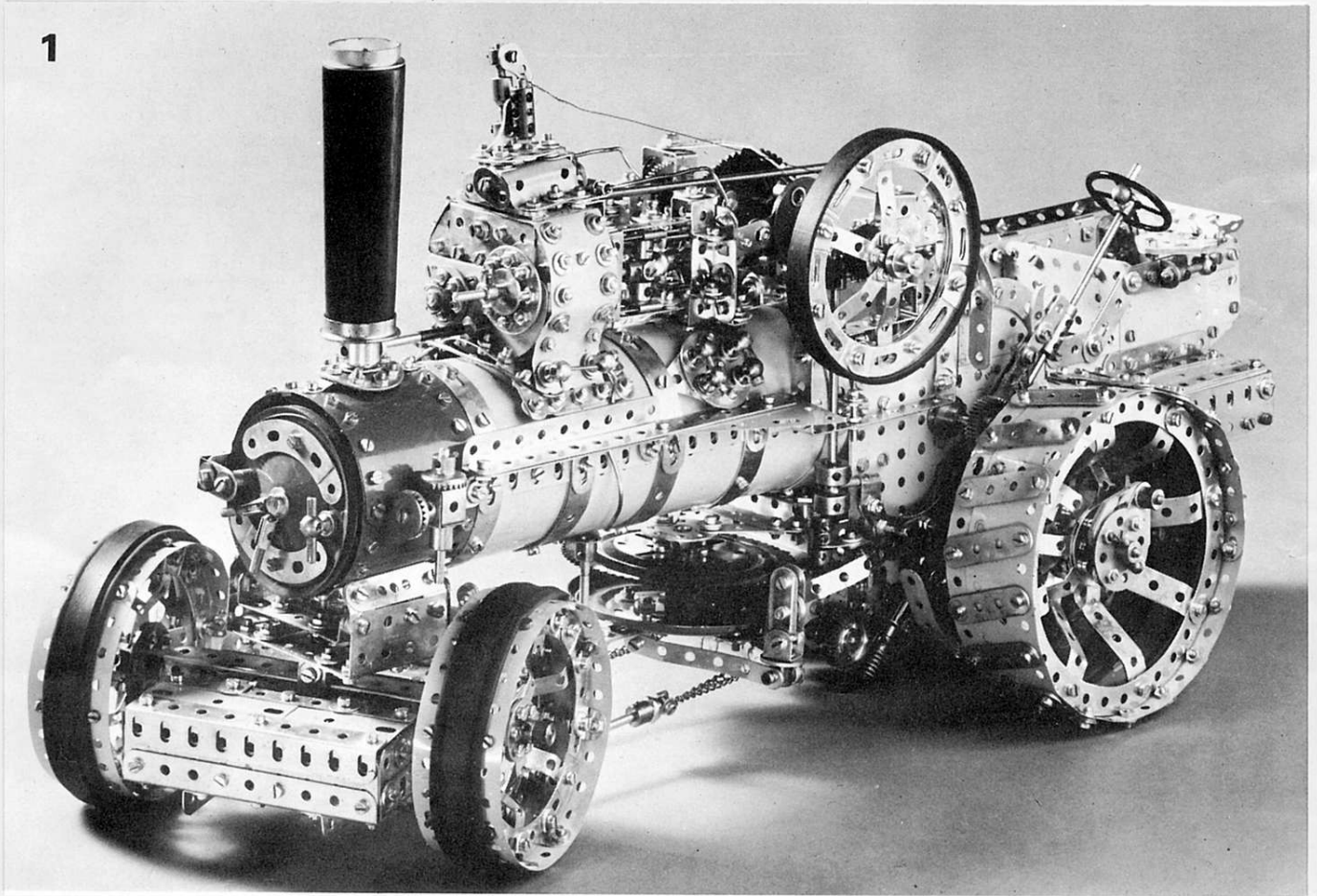

# PLOUGHER – POWER!

A general look at a superb Fowler BB1 Ploughing Engine designed and built by NORMAN GILBERT



Scenic Showmen's Road Locomotives usually steal the glamour at Traction Engine Rallies but there is a great deal to be admired in the mechanical juggernauts which revolutionised agriculture in the UK at the turn of the century. Steam power harnessed to the plough opened up vast areas of the Fens in East Anglia where large tracts of flat land lent themselves to long hauls of the multi-furrow plough by cable between a pair of Fowler Compounds. Great strength in construction, high reserves of steam power and reliability were the hallmarks of the Fowler ploughing engines and they are still to be seen at steam rallies to this day where their owners have as much pride in them as any showman of yesteryear. Norman Gilbert chose the 1916 Fowler BB1 Compound Ploughing Engine for his model and he has achieved a high standard of realism as our cover shot illustrates. This general descriptive article is by Bert Love based on notes from Norman. Although the model appears extremely advanced, it is comparatively easy to construct so long as care is taken in assembly and alignment.

## BOILER

With a 13" length and a 3" diameter this is formed from six pairs of 5½" x 2½" Flexible Plates set to the curvature of a 3" Pulley, overlapped on the first five pairs by one hole with the last pair being butted at the forward end of the boiler and clad externally with black or blue Plastic Plates. Internal reinforcement of the boiler is provided by three 12½" Strips, each side, the bottom of the boiler being bolted on to them as the curved pairs of Flexible Plates are assembled. Co-incident with the lapping of the boiler plating are five sets of four 3" Formed Slotted Strips which provide ornamental banding. Inside, at the rear end of the boiler, additional shorter Strips are added

to the 12½" Strips to give extra support and two 4½" x 2½" Flat Plates are bolted on outside to form the first section of the firebox from which the driving platform and bunker are extended. These Plates are mounted vertically, bolted three holes down from the top to the side joint of the boiler, allowing one hole extension of the Plates behind the rear end of the boiler.

A chimney plate is made from an 8-hole Wheel Disc, carrying a Chimney Adaptor and secured to the boiler top by a 2½" Narrow Strip running fore and aft. An 8" Screwed Rod passes right through the chimney assembly and is secured inside the smoke box to a 2½" Double Angle Strip bolted across the boiler

internally and centralised by packing Washers. Norman's model uses a tapered chimney which can be made from tinplate or cardboard but Standard Flanged Wheels are provided as shown in the illustrations so that the Meccano 3" Cylinder may be used if preferred.

## WHEELS

Use is made of Meccano Curved Strips in the rims of both front and rear wheels, eight 3" Curved Strips being used for each front wheel. These are set up carefully to form a true pair of circles and are spaced by four ½" Double Brackets to give parallel rims. Small Bush Wheels form the outer hubs and standard

6-hole Bush Wheels are used inside, thus providing attachment points for the twelve bent and staggered spokes in the front wheels. Fig. 1 shows the general construction and it will be noted that only four-hole lengths of Narrow Strips are utilised. This means the use either of 2½" Narrow Strips the extra half-inches all stacked on the axle rod, or old Strips cut to four holes (they will finish up bent beyond redemption anyway!). It is important that each spoke is bent to identical shape before assembly (six external spokes and six internal - note slight difference in bending required for the internal large Bush Wheel hub). It is a good idea to set up half of the spokes and the rims and to spin the partially completed wheel to test for concentricity before adding the remainder of the spokes.

A feature of the Fowler Ploughing Engines was the large diameter and broad face of the front wheels. It must be remembered that the ploughing cable was operated at right angles to the boiler which applied a drag reaction to the whole engine and the heavy front wheels assisted in stabilising the engine. These massive engines were very heavy and narrow rim faces would have the engine bogged down rapidly in soft or muddy earth. Three 5½" x 1½" Flexible Plates form the wheel faces, or treads, curved and overlapped uniformly and fixed by ½" Angle Brackets to the wheel rims. By using Set Screws instead of standard Bolts, a shallower extension is achieved on the wheel treads. In the prototype, steel 'tyres' were employed, but the model is provided with rubber tyres made from bands cut from an old innertube.

Rear wheels are constructed from 5½" Circular Girders overlaid on the outside view only with eight 2½" plain Curved Strips. This time, sixteen spokes are provided, each one being six holes long, using eight standard 3" Strips and eight 3" Narrow Strips. A 2" width of 'tread' is achieved on the rear wheels by having 5½" x 1½" Flexible Plates overlapped sideways by two holes. Tread grips are provided by 2" Strips bolted to the wheel faces as shown. Note that the rear wheels are on a solid back axle, but are free to revolve thereon. No differential was used in this Fowler engine, acute turning angles being accommodated by draw-pins which would disconnect the rear wheels from the driving plates on back axle, allowing one wheel to do the work. This operation required nippy action by the engine driver's mate!

**FRONT AXLE AND STEERING**

Fig. 5 shows the details of the front axle which is a pair of 5½" Girders, the lower Girder securing Couplings at each end which

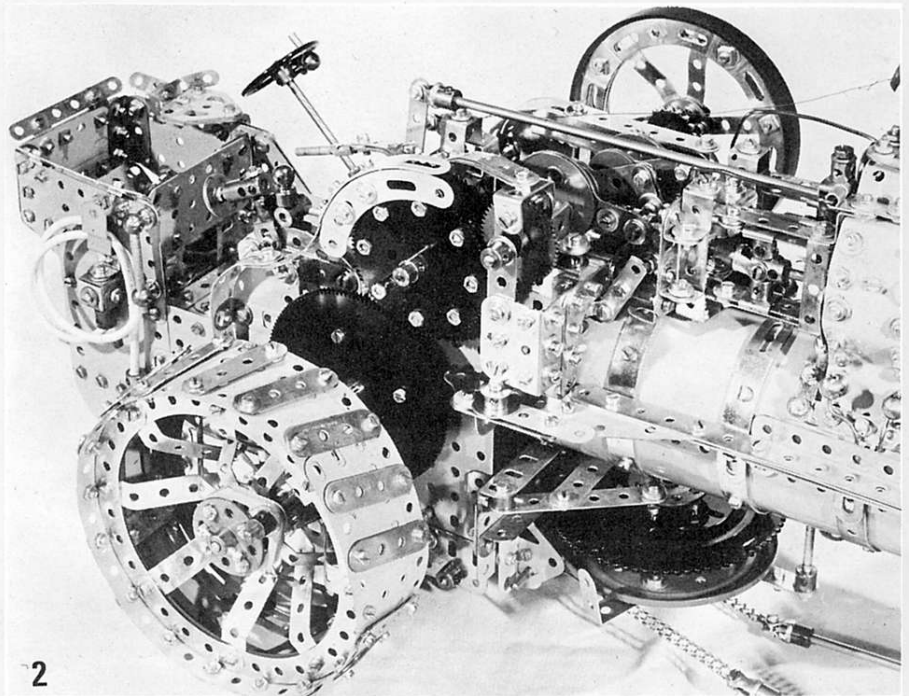

Fig 2, above, shows a close-up view of the crankshaft and right-hand gear train drive to the penultimate drive of Norman Gilbert's Fowler BBI Ploughing Engine. Note that the larger gears illustrated are each provided by two Gear Wheels bolted face-to-face. Fig. 1 on opposite page is a general view of the completed model.

hold fixed 2½" Rods on which the front wheels turn freely, secured externally by Collars. The second 5½" Girder is fixed to the first by Bolts screwed into Threaded Bosses and the vertical slotted flanges of the paired Girders are fitted internally with 2½" Strips, centralised to give an axle pivot. The steering fork is a 1" x ½" Double Bracket locked to a Long Threaded Pin swivelling in 1½" Square Plates fixed in the framework below the smoke-box end of the boiler. Fishplates bolted by their slotted lugs and overlaid with a Washer reinforce the 1" lugs of the steering fork. A 1" Axle Rod passes through the steering fork and centre of the 5½" Girders and this Rod is held in place by an internal Collar set by a screwdriver poked through the centre Girder holes from below to lock the Grub Screw in the Collar.

A toolbox with hinged lid and a "Spud rack" are attached to the other girder members of the front axle assembly as shown. Steering rods, as used in these Fowler Ploughing Engines, are made in the model from 5½" Rods fitted with Rod and Strip Connectors lock-nutted to

the axle assembly as shown and then connected via End Bearings to Sprocket Chain on the steering barrel. "Spuds" are extra steal dogs which can be clamped to the rear wheels in extra-muddy conditions and the Fowler Ploughing engines carried these on a rack across the rear of the front axle.

**MOTION & STEAM CHEST**

No attempt has been made to provide crankshafts on this model and a plain axle rod is used as a substitute. However, sliding gears are provided (two speeds) so that a Meccano Keyway Rod is required to form part of the substitute 'crankshaft', or a short section of Keyway Rod may be cut and extended by a Coupling. Fig. 2 shows the motion in close-up and the Crank supporting the outboard end of the crankshaft is a 'dummy' bearing, free, by lock-nutted Bolt attachment, to 'ride' on the end of the shaft, an inboard bearing actually providing the right-hand support for the crankshaft. Triple-throw Eccentrics are connected to the 2" Axle Rods acting as

Fig. 3, below left, a close-up view of the rear end of the Ploughing Engine showing bunker construction and the driving platform, this filled with an array of interesting knobs and levers. Fig. 4, below right, is a detail view of the rear right-hand side of the model showing the final drive arrangement via double 3½" Gear Wheels to the back axle. Note the bevel drive from the main crankshaft to the winching gear below.

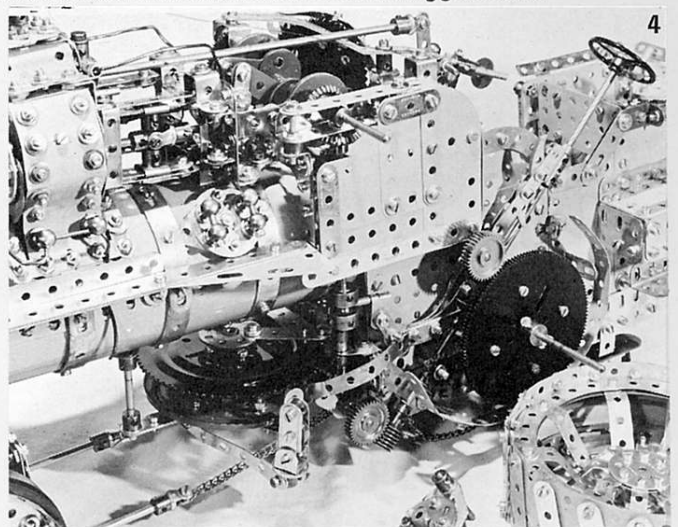
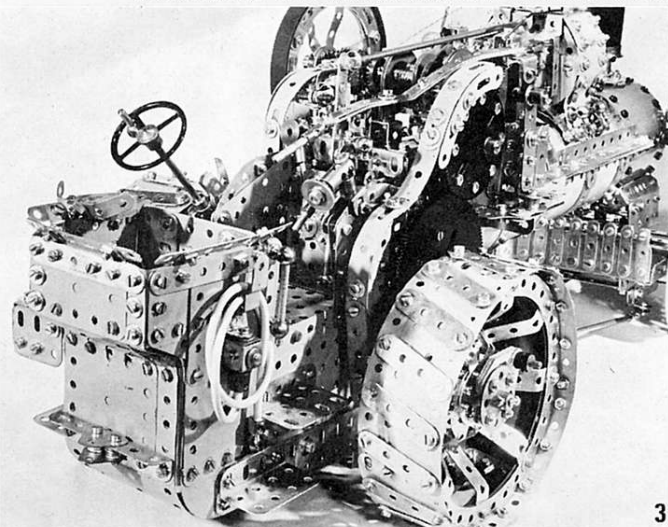

5

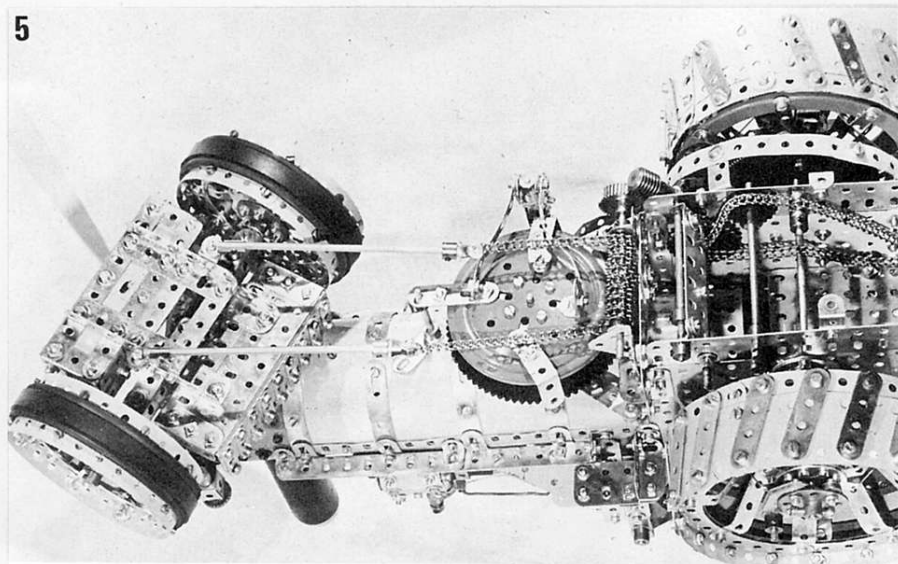

Fig. 5, above, an underside view of Norman Gilbert's Fowler BB1 Ploughing Engine showing the front axle, steering gear and lower winch supports. The loose chain in the section beneath the driving platform is used to take the drive from the powering electric motor which has been removed for this illustration.

← connecting rods for the pistons and Single throw Eccentrics are used for the valve gear. Reversing links on the valve-gear are 1½" Narrow Strips sandwiching the Eccentrics' lugs and the Rod & Strip Connectors on the 4½" Rods carrying the Eccentrics. The lower ends of these 1½" links ride, by lock-nutted Bolts, in double thickness Fishplates which are locked on a 2" Screwed Rod and separated by a Threaded Boss. Two more 1½" Narrow Strips are secured by Nuts to the right-hand end of the Screwed Rod to form a short lever connected to the reversing rod running back to the driver's position.

Sixteen 3" Curved Strips in four layers make a substantial rim for the flywheel which has six Narrow Strips spokes with a slight 'set' bent into them to simulate the Fowler design. A 10" flat rubber driving band for vacuum cleaners is used as the outer rim for appearance sake. Construction of the steam chest is shown in general form in Fig. 7, Channel Bearings and overlapped 2½" Semi-circular Plates forming front and rear facings respectively. Spacing of pistons and valve rods is across four holes, the Eccentric carrying rods being in the centre two holes and one hole above the alignment of the piston Rods. The steam chest and guide frame for the piston crossheads are built as one unit and then fixed like a saddle on to the boiler top.

**WINCH GEAR**

Fig. 4 shows how the drive shaft to the winch is in continuous mesh by Bevel Gears with the main crankshaft, engagement of the winch being operated by Dog Clutch and Socket Coupling arrangement, as shown, the shift lever being carried up to the driving position and normally locked by a toothed rack. Heavy tooth drive to the winch is arranged by ¾" Sprocket meshing with the toothed flange of a Meccano Ball Race and details of the winch are seen in Fig. 4. In the prototype the 'fairlead' which ensures smooth pay-out of the ploughing cable could be swivelled to effect ploughing "on either hand", but a fixed position is maintained in the model.

**MAIN DRIVE**

First and second gear comprise a 50t. Gear and 1" Sprocket running together on the Key-way end of the crankshaft and these can be meshed with the large intermediate double gear mounted on the offside of the engine. A back-to-back pair of 2½" Gears bolted to a 3" Sprocket provide adequate meshing faces for the intermediate gear which is in constant mesh with a pair of 3½" Gear Wheels, also back-to-

back for additional meshing face. Running through the framework is a 5" Axle Rod journalled in the vertical 4½" x 2½" Flat Plates, on the back row of holes, four holes down and this takes the drive to the other side of the engine where one more doubled-up pair of 3½" Gear Wheels is firmly locked to the rear axle, supplied by a cut or composite rod of 10½" length. The freely-running composite intermediate gear on the off-side of the engine is mounted on a Rod fixed in the centre transverse bore of a Coupling which is adjusted for height by lock-nuts on two 1" Screwed Rods mounted vertically on the engine frame. These Rods pass through the other two transverse bores of the Coupling, thus, by this method, the intermediate gear can be adjusted into position to mesh with the gear-change spacing required. The general arrangements may be seen in Figs. 2 and 4.

**FITTINGS**

Fittings are largely a matter of personal choice, but the running boards on the boiler, the boiler inspection plates, water pick-up hose and smoke box door are based on the original Fowler BB1. A 3" Pulley, plus Conical Disc and two 2½" Stepped Curved Strips make the smoke-box which is hinged to the boiler as shown. Ornamental lamps are optional, of course, but may be constructed from ½" Double Brackets, Conrate Wheels, etc., as shown. There is sufficient room inside the rear portion, below the footplate, to accommodate several different makes of Meccano electric motor (one at a time of course!) so that the model is set in motion by chain drive to the crankshaft. Mounted on a plinth with the wheels raised, this makes a very attractive exhibition model and, although Norman Gilbert only took up serious Meccano modelling last year on joining the S.A.M.C. it is clear from the model that he has already reached a very high standard.

The model, in fact, does illustrate an important point, namely that you do not have to be a modeller of countless years experience before being able to tackle advanced constructional projects. A basic mechanical ability is of course required, plus modelling commonsense and a knowledge of the Meccano parts available, with an understanding of their uses. A certain amount of courage is also desirable - the courage to knuckle down and actual start building - but, with the Fowler, Norman has proved that success is possible even for the comparative newcomer to the hobby.

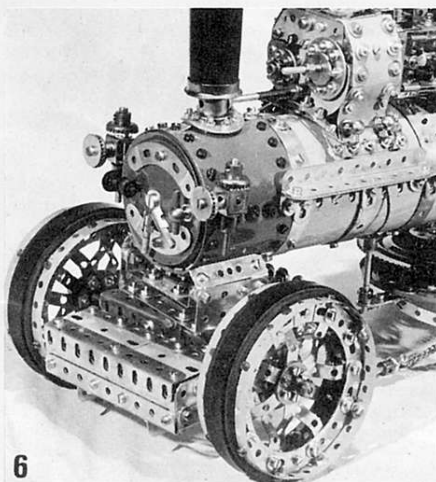
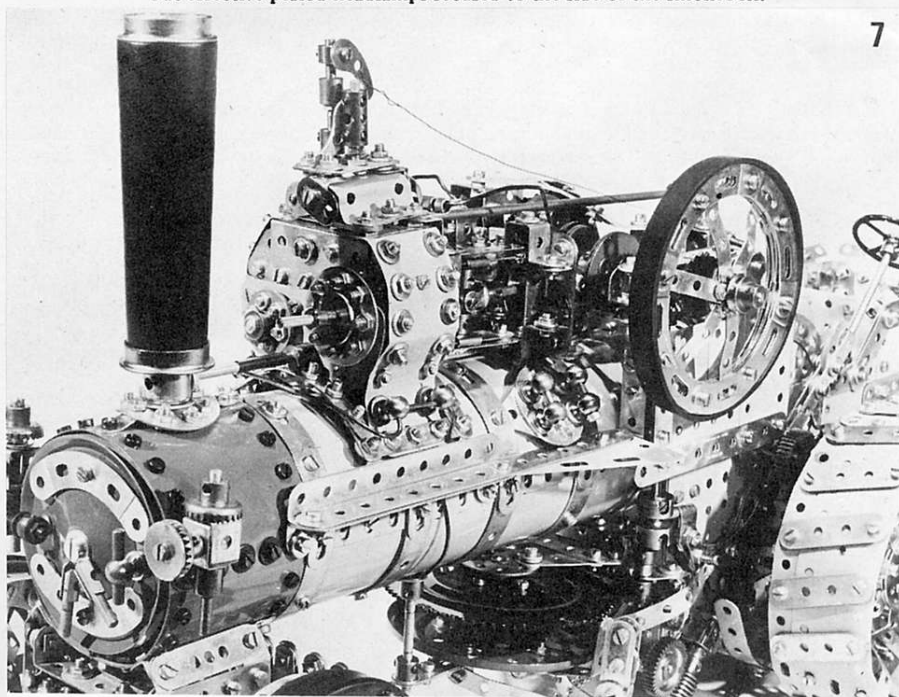

Fig. 6, above, a close-up view of the front axle and smoke box end of the boiler. Fig. 7, below, another close-up view, this one showing the steam chest, valve gear and flywheel. Note the simple but effective period headlamps secured to the side of the smokebox.



7