

New Meccano Models

A Simple Loom and a Fine Army Lorry

MANY model-builders have asked for details of a simple model hand loom that can be built from a small Outfit. In response to these

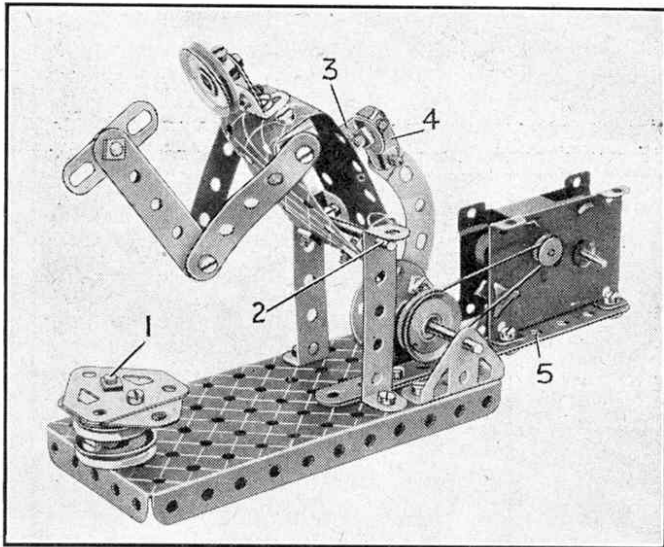

Fig. 1. "The Village Blacksmith." An amusing Outfit No. 1 model that can be set in motion by means of a Magic Motor.

requests we include a model of this kind among the four new models we are describing this month. It is shown in Fig. 2, and can be built from the parts in Outfit No. 3. The other three models are a fine army lorry, a simple horse and cart and a working blacksmith operated by a *Magic Motor*. All of these are quite simple and require only a few parts for their construction.

The blacksmith is shown in Fig. 1. The figure is operated by a *Magic Motor*, and when this is set in motion the blacksmith strikes the anvil with real gusto! The model is simple to build and all the parts required with the exception of a 1" Screwed Rod are contained in Outfit No. 1.

The blacksmith and his anvil are mounted on a base consisting of a $5\frac{1}{2} \times 2\frac{1}{2}$ " Flanged Plate. The anvil consists of a 1" Pulley, a 1" loose Pulley and two Flat Trunnions, held together on a 1" Screwed Rod 1 as shown. The blacksmith's legs are two $2\frac{1}{2}$ " Double Angle Strips, in the upper end holes of which a 2" Rod 2 is held. The body is formed from a $1\frac{1}{2} \times 5\frac{1}{2}$ " Flexible Plate bent to

U-shape, and it is pivoted on the Rod 2 by means of four Angle Brackets bolted one to each of its corners. The Rod passes through the free holes in the Angle Brackets. The arms are $2\frac{1}{2}$ " Strips, and the hammer consists of two $2\frac{1}{2}$ " Strips fitted with two Flat Brackets to form the head.

The blacksmith's head is a 1" Pulley held on a bolt passed through a Flat Bracket forming his neck. The Flat Bracket is attached to the Flexible Plate by means of an Angle Bracket. At the back of the body is bolted a 1" Reversed Angle Bracket 3, and this is used to attach the blacksmith to the operating mechanism. An Angle Bracket is bolted to the free arm of the Reversed Angle Bracket and this in turn carries a Flat Bracket 4. The Flat Bracket is pivotally

attached by a lock-nutted bolt through its free hole to one end of a $2\frac{1}{2}$ " Curved Strip, the other end of which is similarly lock-nutted to a Bush Wheel. The Bush Wheel is mounted on a 2" Rod journalled in Trunnions bolted to the Flanged Plate. The Rod carries a 1" Pulley. Care must be taken to see that the Curved Strip pivots quite freely on its bolts and is not fixed tightly in position.

A *Magic Motor* is bolted to two $5\frac{1}{2}$ " Strips 5 placed face to face and fixed to the base so as to project from one end, as shown. The drive from the small pulley of the Motor is transmitted to the 1" Pulley by means of a Driving Band.

Parts required to build the model Blacksmith: 2 of No. 2; 4 of No. 5; 4 of No. 10; 8 of No. 12; 2 of No. 17; 3 of No. 22; 1 of No. 22 $\frac{1}{2}$; 1 of No. 24; 24 of No. 37a; 25 of No. 37b; 2 of No. 35; 2 of No. 48a; 1 of No. 52; 1 of No. 82; 2 of No. 111c; 2 of No. 125; 2 of No. 126; 2 of No. 126a; 1 of No. 186; 1 of No. 189; 1 *Magic Motor* (not included in Outfit).

The Hand Loom shown in Fig. 2 should be commenced by building the base. This consists of a $5\frac{1}{2} \times 2\frac{1}{2}$ " Flanged Plate mounted on two $5\frac{1}{2} \times 1\frac{1}{2}$ " Flexible Plates fixed at each side between the flanges of the Flanged Plate and 12 $\frac{1}{2}$ " Strips. Two $5\frac{1}{2}$ " Strips are attached to the $5\frac{1}{2} \times 1\frac{1}{2}$ " Flexible Plate, and between their outer ends they clamp $1\frac{1}{2} \times 2\frac{1}{2}$ " Flexible Plates to vertical

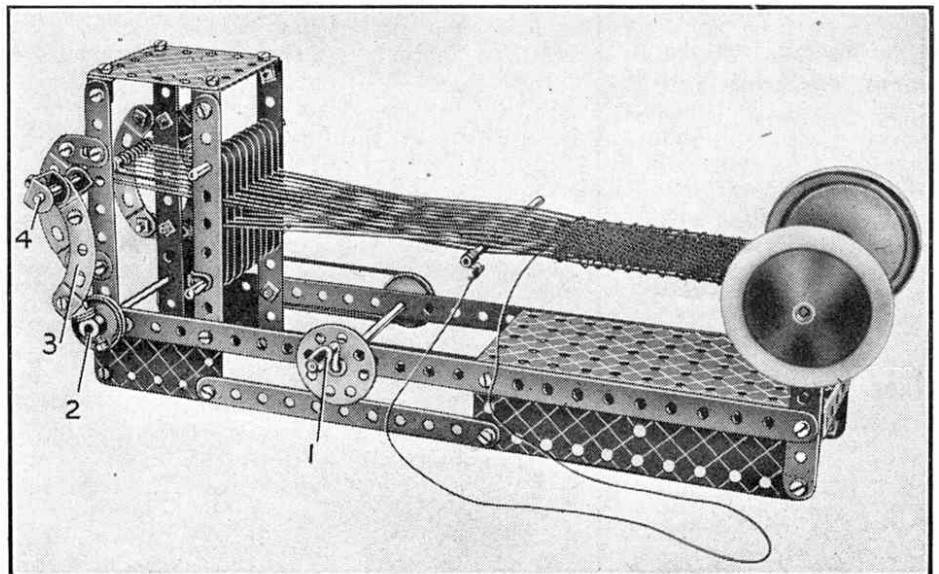

Fig. 2. A simple Hand Loom. This model can be built from the parts in Outfit No. 3.

5½" Strips. The upper edges of the 1½"×2½" Flexible Plates are bolted to the 12½" Strips already mentioned. An Axle Rod carrying at each end a Road Wheel is journalled in two vertical 5½" Strips at the front of the model.

Construction of the warp separating arrangement at the other end of the machine is commenced by attaching two 2½" Curved Strips to the rear pair of vertical 5½" Strips in the manner shown in the illustration, by means of two Flat Brackets. Nine 2½" Strips separated from each other by Spring Clips are then placed vertically between the middle pair of vertical 5½" Strips and a 3½" Axle Rod is pushed through their end holes as shown. The Rod 4 is passed between the Curved Strips,

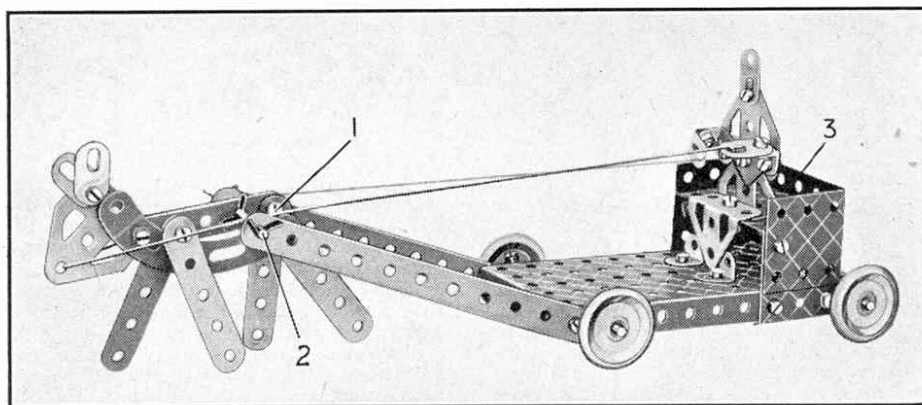

Fig. 4. All the parts required to build this model Horse and Cart are contained in Outfit No. 1.

The sturdy model lorry shown in Fig. 3 is based on the heavy transport wagons used in the British Army. The chassis consists of two

which are overlapped as shown.

The sides of the cab are formed by Flat Trunnions fixed to Plate 2 by Trunnions. The Flat Trunnions are connected by a 2½"×½" Double Angle Strip, to which a 2½"×1½" Flexible Plate that has been curved slightly is bolted to form the front of the cab. The six road wheels are 1" Pulleys fitted with 1" Motor Tyres. The rear axles are journalled in two 2½" Strips 4. These Strips are pivoted through their centre holes on lock-nutted bolts, which pass through Flat Brackets bolted to the chassis. This arrangement forms a pivoted bogie and allows the wheels to ride easily over irregularities in the ground, in very much the same manner as the independently sprung axles of the prototype. The front axle is journalled directly in Flat Brackets bolted to the chassis.

A Magic Motor forms an ideal power unit for a wheeled model of this kind and if one is available it should be fitted under the chassis and connected by a Driving Band to a Pulley on the front axle.

Parts required to build the model Army Lorry: 8 of No. 2; 2 of No. 4; 3 of No. 5; 2 of No. 6; 4 of No. 10; 8 of No. 12; 3 of No. 16a; 6 of No. 22; 58 of No. 37a; 56 of No. 37b; 4 of No. 38; 2 of No. 48; 1 of No. 48a; 1 of No. 52; 2 of No. 124; 2 of No. 126; 4 of No. 126a; 6 of No. 142c; 6 of No. 188; 2 of No. 189; 1 of No. 190; 2 of No. 215.

The remaining model to be described is the simple Horse and Cart shown in Fig. 4. The horse's head is a Flat Trunnion and Flat Brackets are used to represent ears. His body is a 2½" Strip bolted to a 2½" Curved Cranked Strip. His legs are 2½" Strips. His forelegs are spaced apart by three Washers and his hind legs by a Reversed Angle Bracket. One of the bolts holding the Bracket is shown at 1, and the other passes through the left-hand hind leg.

Parts required to build the Horse and Cart: 5 of No. 5; 4 of No. 10; 5 of No. 12; 2 of No. 16; 1 of No. 17; 4 of No. 22; 1 of No. 24; 4 of No. 35; 20 of No. 37; 3 of No. 38; 1 of No. 90a; 1 of No. 125; 2 of No. 126; 2 of No. 126a; 4 of No. 142c; 2 of No. 189.

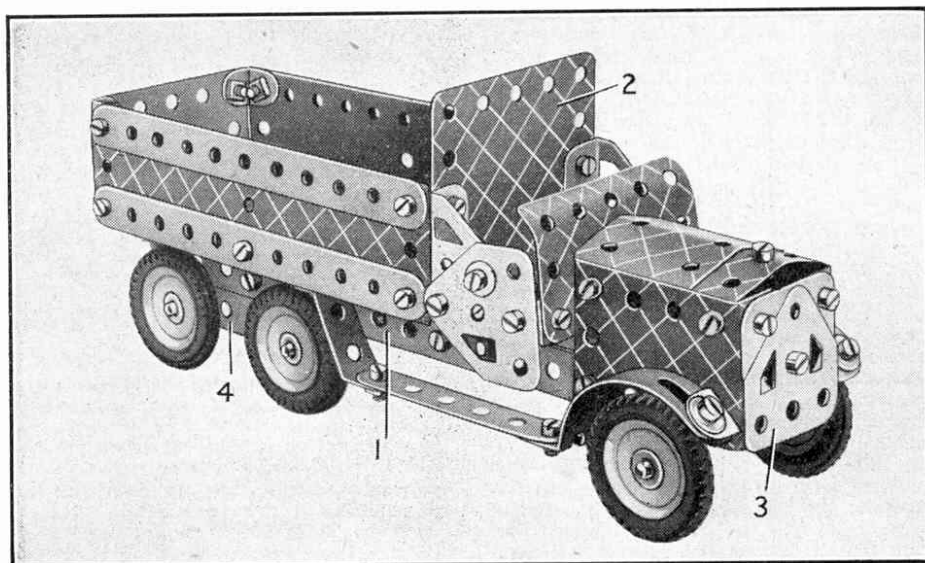

Fig. 3. A sturdy model Army Lorry, a fine subject for model-builders interested in wheeled vehicles.

each end of it being secured by means of a Reversed Angle Bracket to a 2½" Curved Strip 3, which is kept in position by two Double Angle Brackets. The other ends of the Curved Strips are attached by means of Angle Brackets to the bosses of two 1" Pulley Wheels locked on each end of the Rod 2.

The warp separating movement is operated by turning a Crank Handle 1 journalled in the 12½" Strips of the base as shown. The Crank Handle is held in place by a Bush Wheel at one end and a 1" Pulley at the other. A Driving Band connects this 1" Pulley with a second Pulley on the Rod 2.

Parts required to build model Loom: 2 of No. 1; 6 of No. 2; 2 of No. 3; 9 of No. 5; 4 of No. 10; 2 of No. 11; 2 of No. 12; 2 of No. 15b; 3 of No. 16; 2 of No. 17; 1 of No. 19g; 3 of No. 22; 1 of No. 24; 6 of No. 35; 38 of No. 37a; 40 of No. 37b; 6 of No. 38; 1 of No. 40; 2 of No. 48a; 1 of No. 52; 4 of No. 90a; 2 of No. 125; 1 of No. 186; 2 of No. 187; 2 of No. 188; 2 of No. 189; 1 of No. 190; 1 of No. 213.

side members 1, each of which is formed from two 5½" Strips overlapped five holes and bolted together. The side members are joined at their centres and rear ends by 1½"×½" Double Angle Strips, and to the centre one of these the 5½"×2½" Flanged Plate that forms the lorry body is attached. The rear of the Flanged Plate is attached by Angle Brackets to the side members.

The sides and rear of the body consist of two 5½"×2½" and one 2½"×1½" Flexible Plate, and are bolted in position together with the 2½"×2½" Flexible Plate 2, which forms the back of the driving seat. The sides of the bonnet are built up from two 2½"×1½" Flexible Plates bolted to the side members 1 and connected at the front by the Flat Trunnions 3 that form the radiator. The bonnet top also consists of 2½"×1½" Flexible Plates,

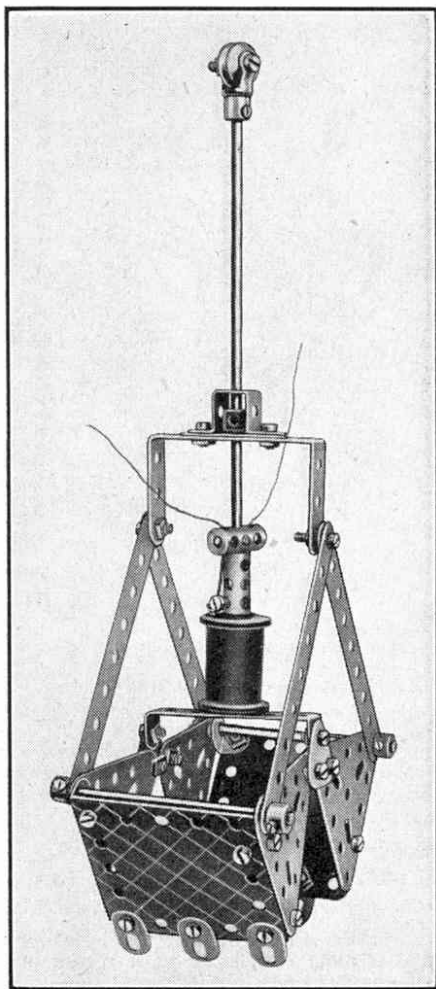

Fig. 474

Many different types of quick return motions have appeared in "Suggestions Section" from time to time, and a further interesting example is shown in Fig. 472. This movement is of special interest, as it is a distinct departure from the usual lever or gear-operated quick return movement. Its action is controlled by a spring, and therefore is quick and positive.

Construction of the mechanism is carried out in the following manner. The driving shaft 2 is journaled in two $2\frac{1}{2}$ " Triangular Plates secured in the slotted holes of $2\frac{1}{2}$ " Angle Girders, which are spaced from the base plate by two Washers on each securing bolt. The bearings for the driven Rod 1 are formed by 2" Strips held in Trunnions. The two sets of bearings should be so arranged that the centres of the Rods are exactly $\frac{1}{2}$ " apart, and it is essential that the Rods should be parallel to each other.

Two Face Plates 3 are secured on the Rod 1 and spaced apart about $\frac{3}{8}$ ", with the slots in each Plate directly opposite. The Face Plates 4 are mounted in a similar manner on the Rod 2, and a $1\frac{1}{2}$ " Rod 5 is passed through slots in each pair of Plates. The Rod carries five $\frac{1}{2}$ " loose Pulleys arranged as shown, and a Collar on each end of this Rod holds it in position. The Face Plates should be spaced so that the Pulleys slide freely. A Spring that controls the movement of the gear is fitted to one end of the Rod, and the other end of the Spring is secured by a $\frac{3}{8}$ " Bolt to one of the Face Plates 3.

The drive from the Rod 1 passes through the Face Plates to the Rod 2 by means of

the Rod 5. This Rod slides up and down in the slots, so that in its lowest position it is at the lower ends of the slots in the Face Plates 3, and at the upper ends of the slots in the Face Plates 4. Thus the Rod 2 rotates faster than the Rod 1, but as the Plates continue to rotate the difference in speed of the two Rods is gradually reduced, while in the second half revolution Rod 1 rotates more quickly than Rod 2.

(473) Synchronous Motor

(G. Woolfenden, Liverpool)

Figs. 473 and 473a show a synchronous motor built up from Meccano parts. The model is exceptionally robust, and is designed to work from a Meccano 6-volt Transformer connected to 50 cycle A.C. mains.

Construction is commenced by winding eight Meccano Bobbins to capacity with No. 23 gauge enamel covered wire. These are then wired together in series, and the free ends of the first and eighth coils are taken to Terminals on the 1" Triangular Plate shown in Fig. 473. Each coil is held in a built-up yoke, each half of which is constructed from two Angle Brackets and a Flat Bracket held on a $\frac{1}{2}$ " Bolt as shown. Washers are placed on each side of the Flat Bracket to space it centrally between the Angle Brackets.

The units are then connected together by means of 1" Screwed Rods passed through the Angle Brackets of each unit and a Rod Socket as shown, and held in place by means of a nut on each end. The Coils are then slipped in the yokes and the nuts on the Screwed Rods are tightened up. Insulation in the form of sheet fibre or a wrapping of brown paper should be placed around the Bobbins to prevent the possibility of short circuiting.

The units are then linked together by means of the Flat Brackets, as shown. Finally, an Angle Bracket and a $1\frac{1}{2}$ " Strip are slipped on the threaded shank of each Rod Socket, and the other end of the Strip is bolted to a Face Plate by $\frac{1}{2}$ " Bolts, a Washer and a Collar being placed on the underside.

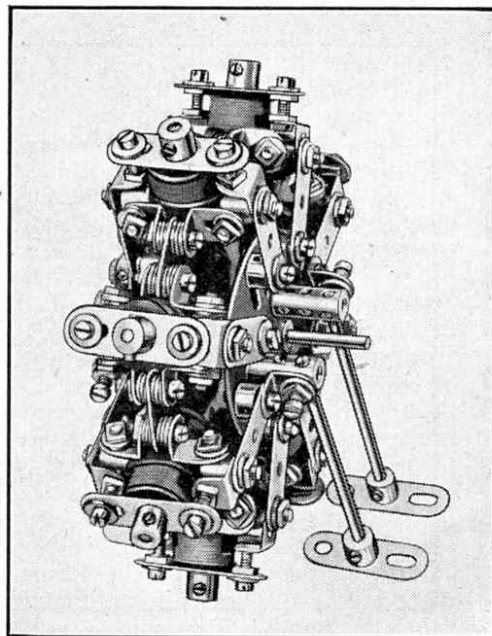

Fig. 473a

The rotor consists of a 3" Sprocket Wheel mounted on a $3\frac{1}{2}$ " Axle Rod, which rotates in the bores of the two Face Plates. Care must be exercised in aligning the bosses of the Face Plates, and the various nuts and bolts should not be tightened up until the Rod runs quite freely.

The Angle Brackets attached to the $1\frac{1}{2}$ " Strips are connected by $\frac{1}{2}$ " Bolts to Double Arm Cranks, through which $1\frac{1}{2}$ " Axle Rods are pushed. These Rods form the cores of the magnets, and their inner ends should be as near as possible to the teeth of the Sprocket Wheel.

If the Bobbins are wound as described the motor is suitable for working from any of the 6-volt Meccano Transformers. To start it the rotor spindle should be spun at approximately 100 r.p.m., which is its normal working speed.

(474) Electro-Magnetic Grab

(P. Hands, Hillingdon)

An electro-magnetic grab fitted to a Meccano crane will greatly increase the fun and pleasure obtained from operating it. A

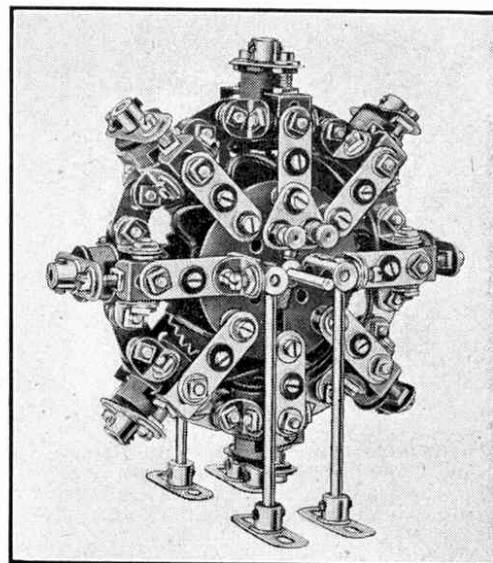

Fig. 473

simple method of constructing such a grab is shown in Fig. 474. The principal feature of this device is that only one cord is used for hoisting and lowering and opening and closing the jaws.

Four $4\frac{1}{2}$ " Strips are pivoted on 3" Rods pushed through holes in the $2\frac{1}{2}$ " Triangular Plates, and are held in place by Collars as shown. The upper ends of the Strips are pivotally connected by lock-nutted bolts to a $2\frac{1}{2}$ " x $1\frac{1}{2}$ " Double Angle Strip. To the centre of this Double Angle Strip is bolted a Double Arm Crank and a Double Bent Strip as shown. A 6" Rod, which at its lower end carries a Coupling, is passed through the centre holes in the Double Bent Strip, Double Arm Crank and Double Angle Strip. The Coupling on this Rod is connected to an Elektron Electro-Magnet, which has a tightly-fitting Core, and is held in place by the grub screws in the lower end of the Coupling. The 6" Rod must not touch the Core of the Magnet. Above the first Coupling is a second similar part placed at right angles to the first Coupling. At the upper end of the 6" Rod is a Small Fork Piece, between the arms of which is mounted a $\frac{1}{2}$ " loose Pulley around which passes the hoisting and grab opening cord.